

# Guía de Armado Serie 100 AR Corrediza 2 Pistas

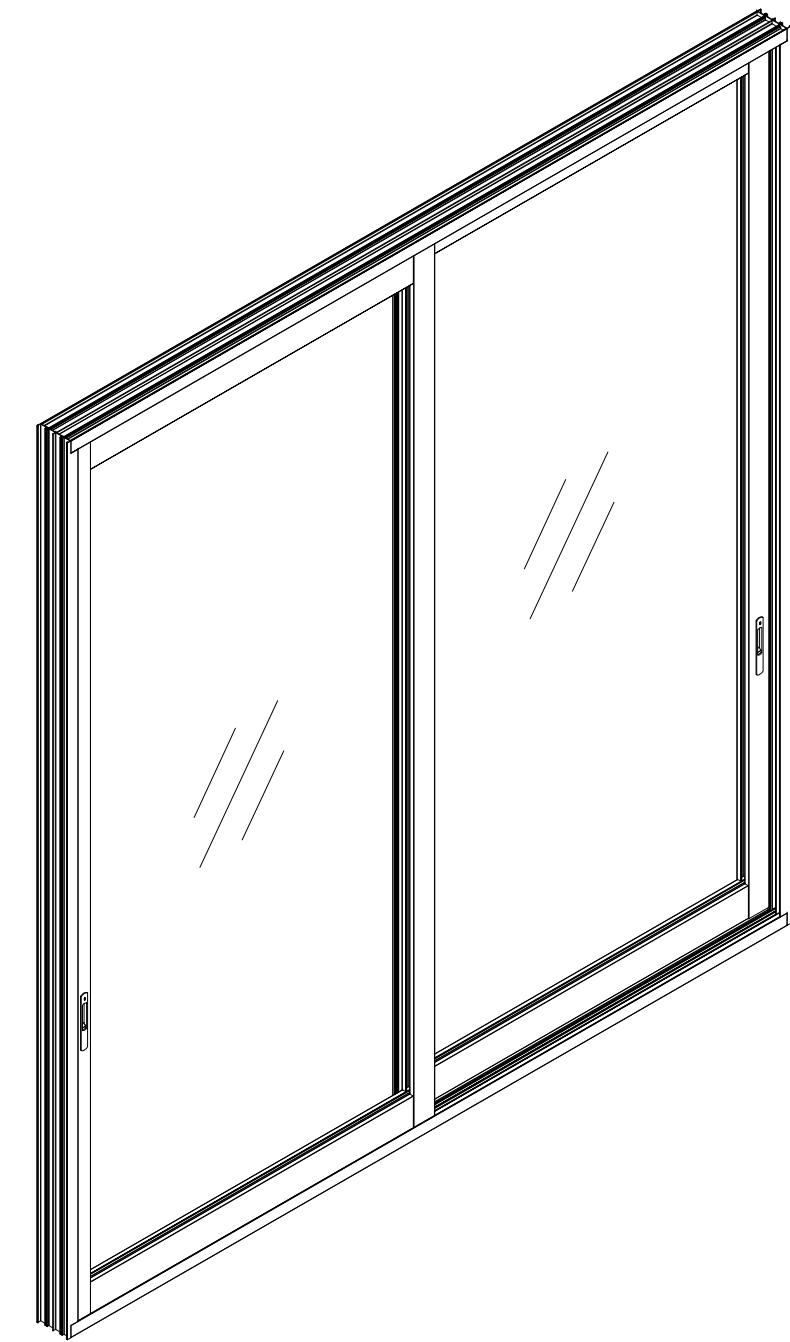

Revisión : 3  
Fecha : Sept 2020

www.ventanaseurovent.com  
eurovent@cuprum.com



## Perfiles Serie 100 AR Corrediza

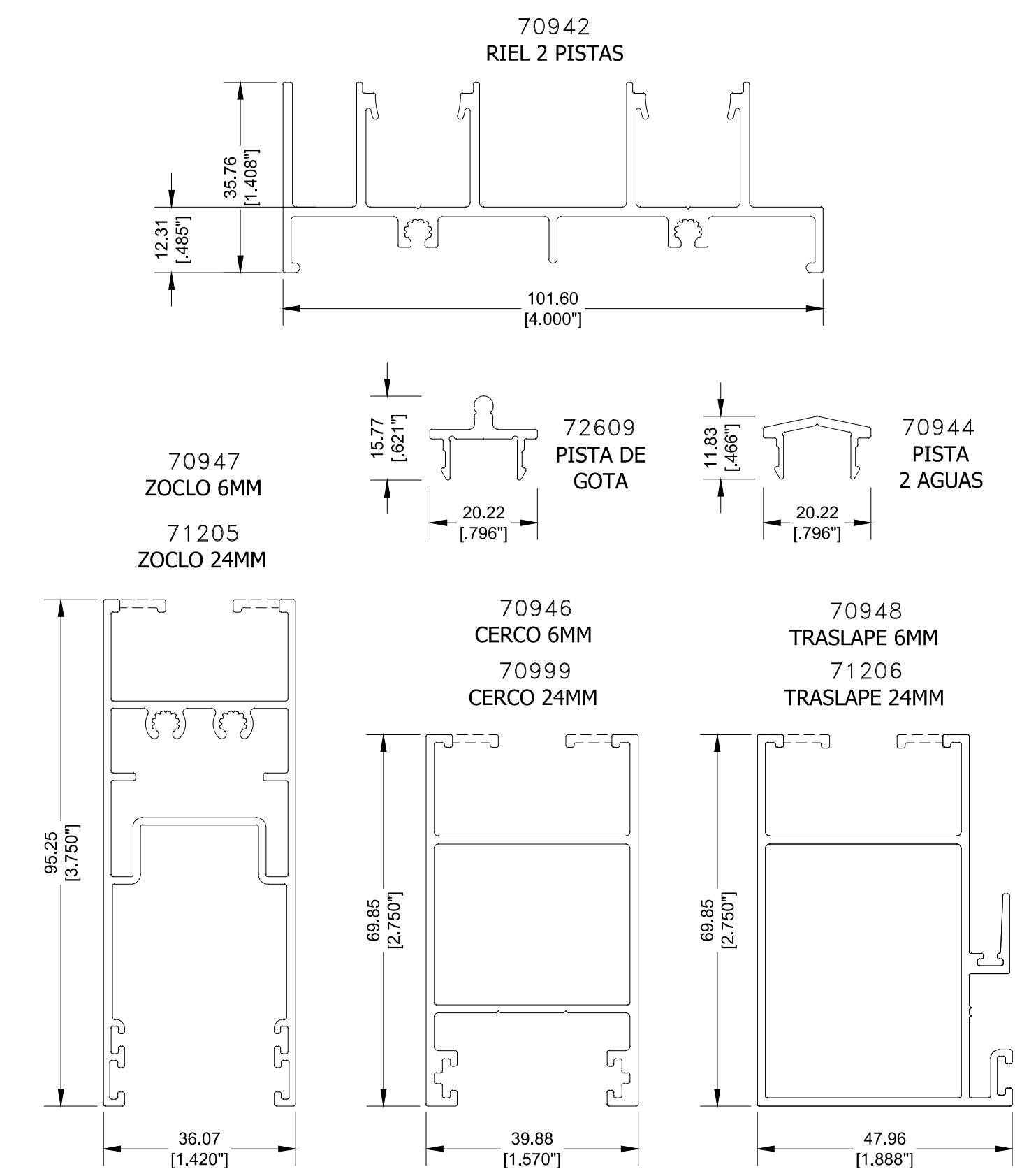

Perfiles básicos para el armado de una Puerta en solución corrediza XX, para ver toda la gama de perfiles para la realización de más soluciones, busca los catálogos en [www.cuprum.com](http://www.cuprum.com)

ESCALA 1:1



## Accesorios Serie 100 AR Corrediza

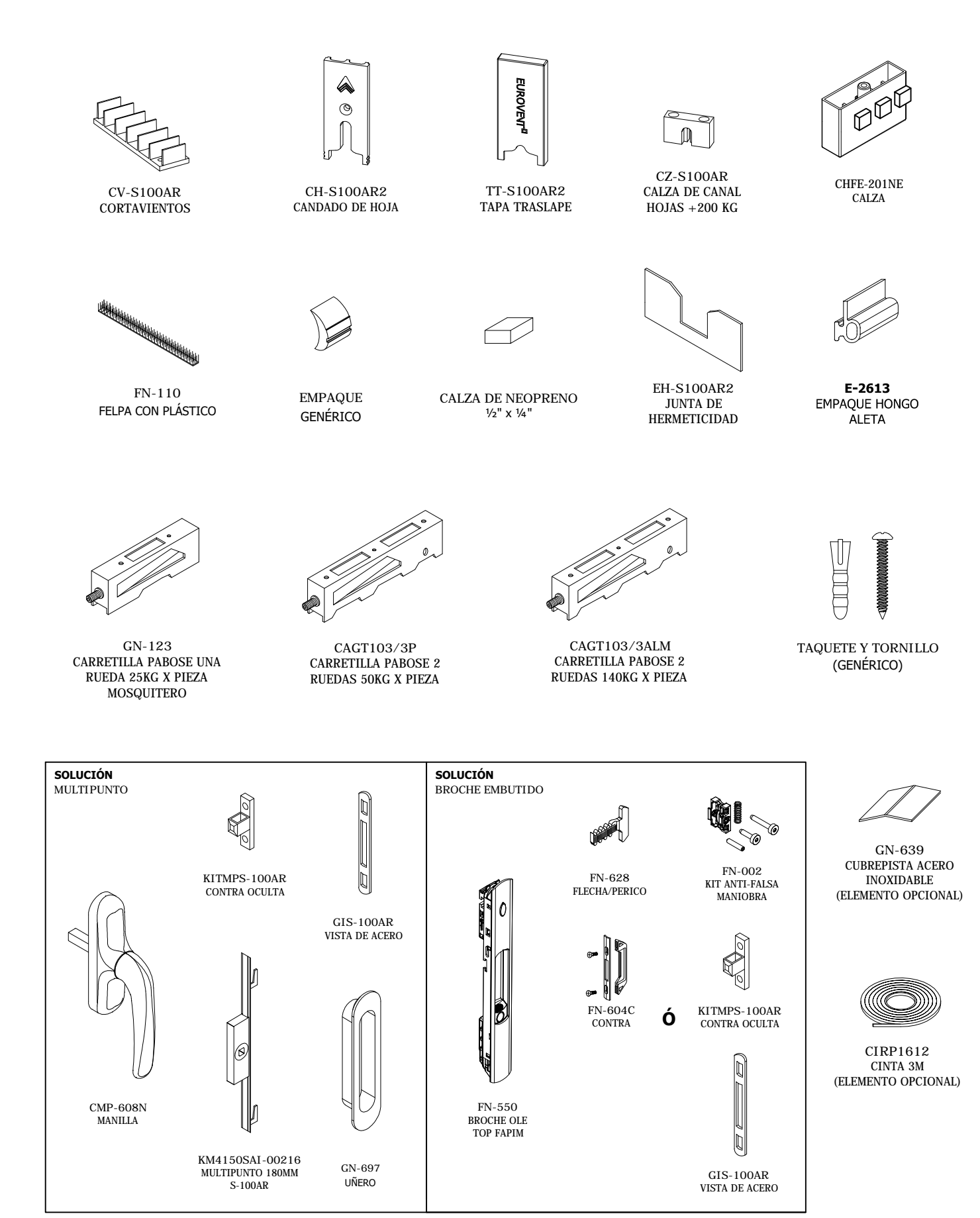

SIN ESCALA



## Gráfica de Dimensiones Máximas de Utilización Serie 100 AR Corrediza

DEFLEXIÓN MAX. L/175

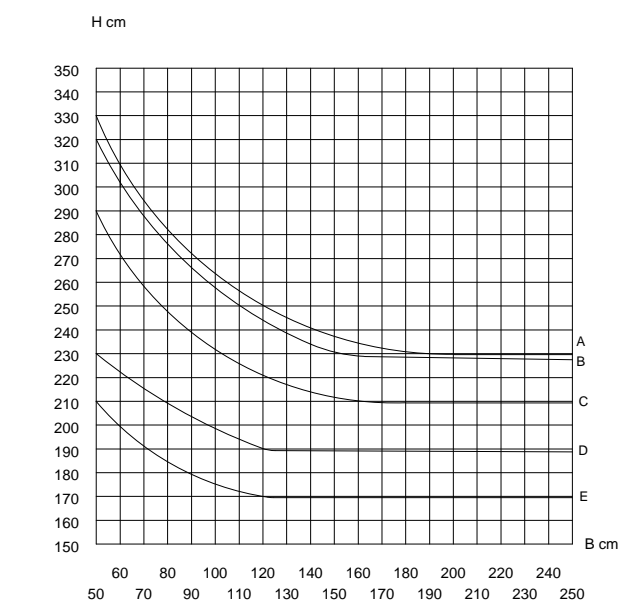

Curvas	Presión del diseño	Velocidad de viento	Zona
A	45 Kg/m <sup>2</sup>	80 Km/h	Centro de grandes ciudades
B	50 Kg/m <sup>2</sup>	90 Km/h	Barrios Residenciales
C	65 Kg/m <sup>2</sup>	120 Km/h	Campo Abierto
D	110 Kg/m <sup>2</sup>	160 Km/h	Zona Costera
E	165 Kg/m <sup>2</sup>	200 Km/h	Zona de Huracanes

Ixx= 25.6 cm<sup>4</sup>

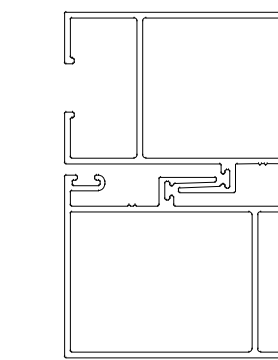

Ixx= 25.0 cm<sup>4</sup>

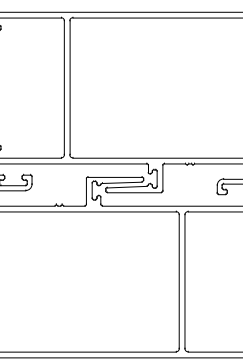

ALEACIÓN: 6063  
TEMPLE: 5

LOS LÍMITES DE UN CANCEL VAN EN FUNCIÓN DE LA COMBINACIÓN DE RESISTENCIA DEL PERFIL DE ALUMINIO, EL VIDRIO Y LOS ACCESORIOS QUE LO INTEGRAN.

ESCALA 1:2



## Cortes Seccionales Serie 100 AR Corrediza

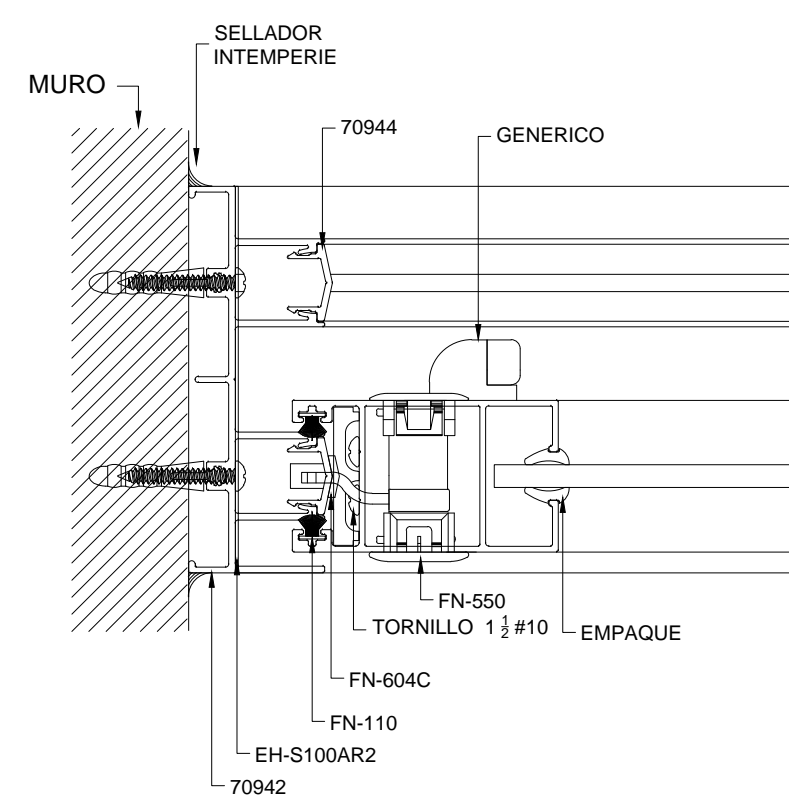
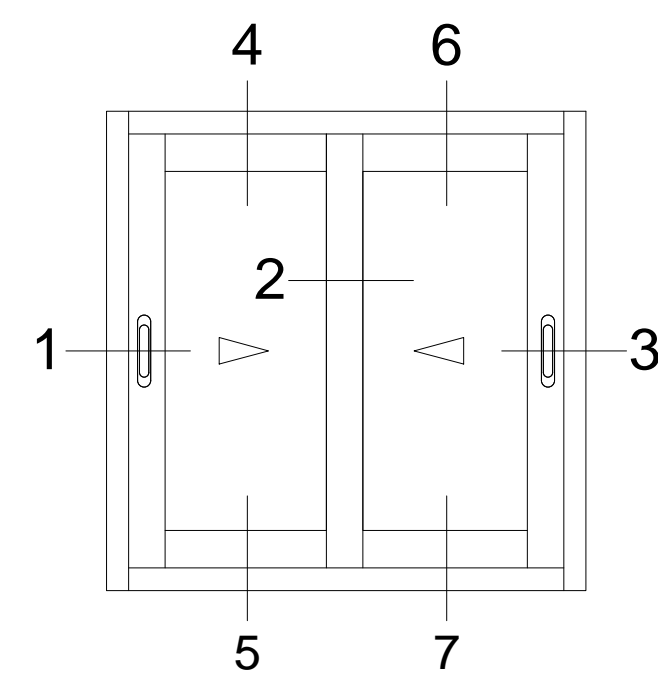

SECCIÓN 1

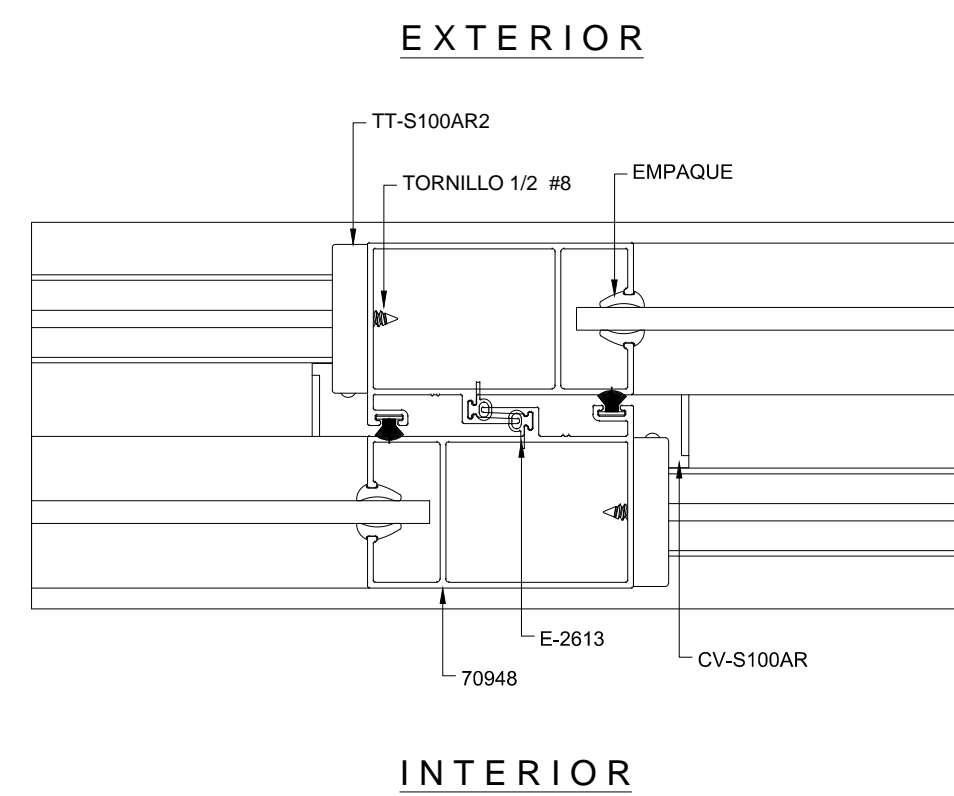

SECCIÓN 2

ESCALA 1:2

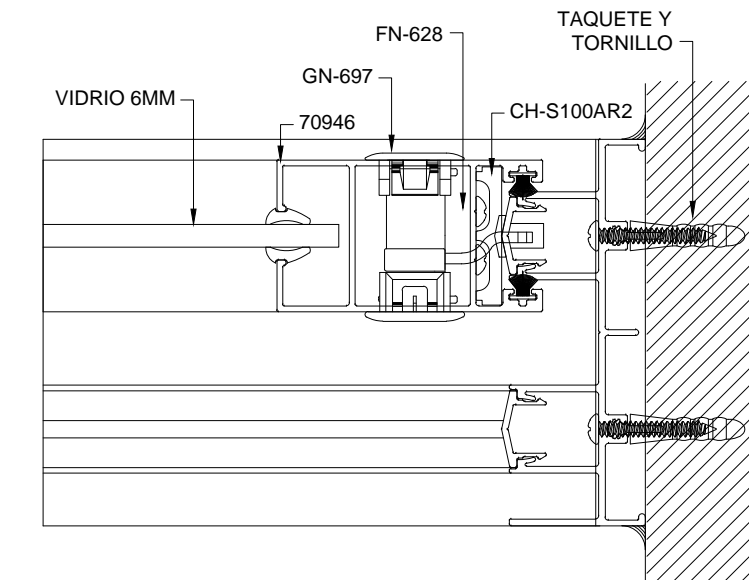

SECCIÓN 3

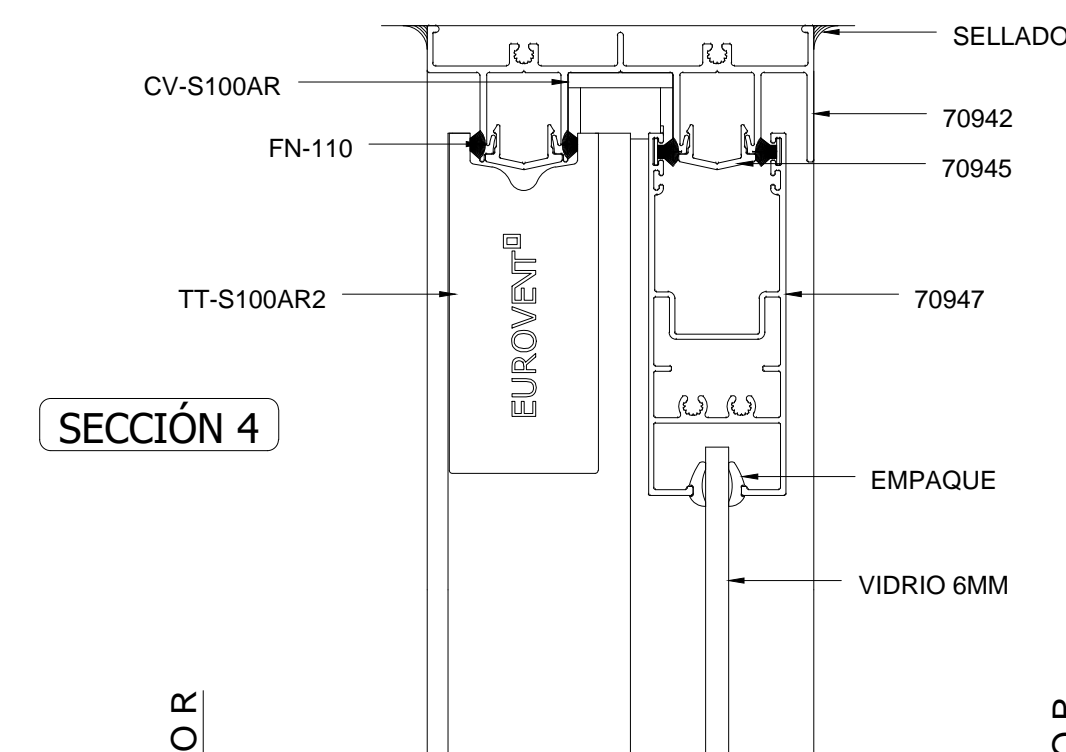

SECCIÓN 4

EXTERIOR

INTERIOR

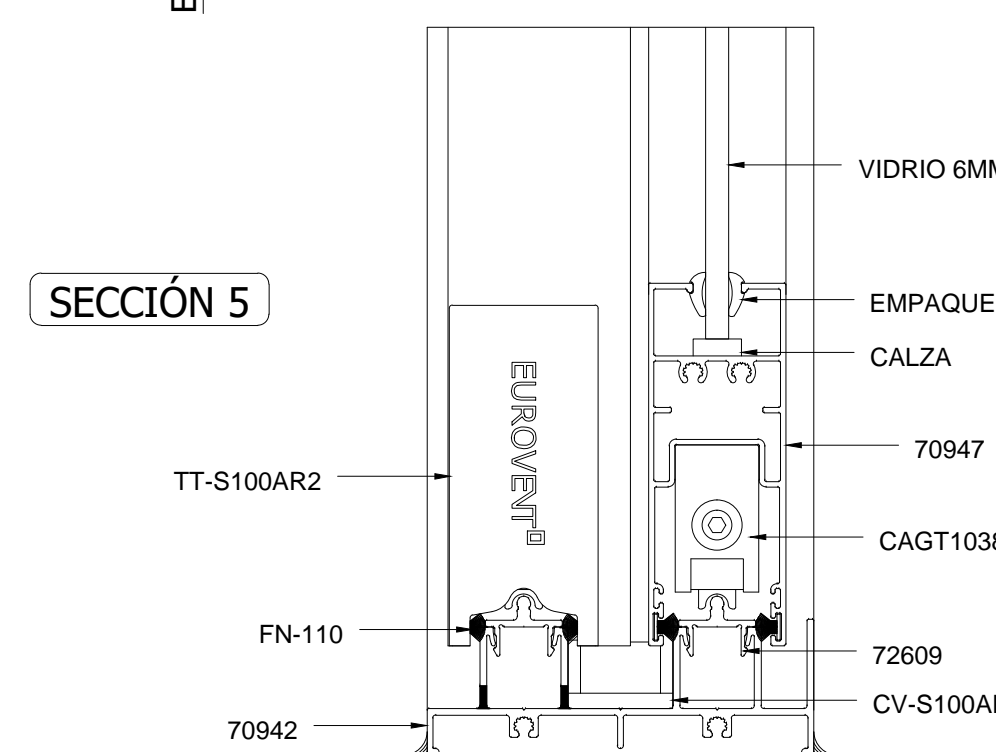

SECCIÓN 5

ESCALA 1:2

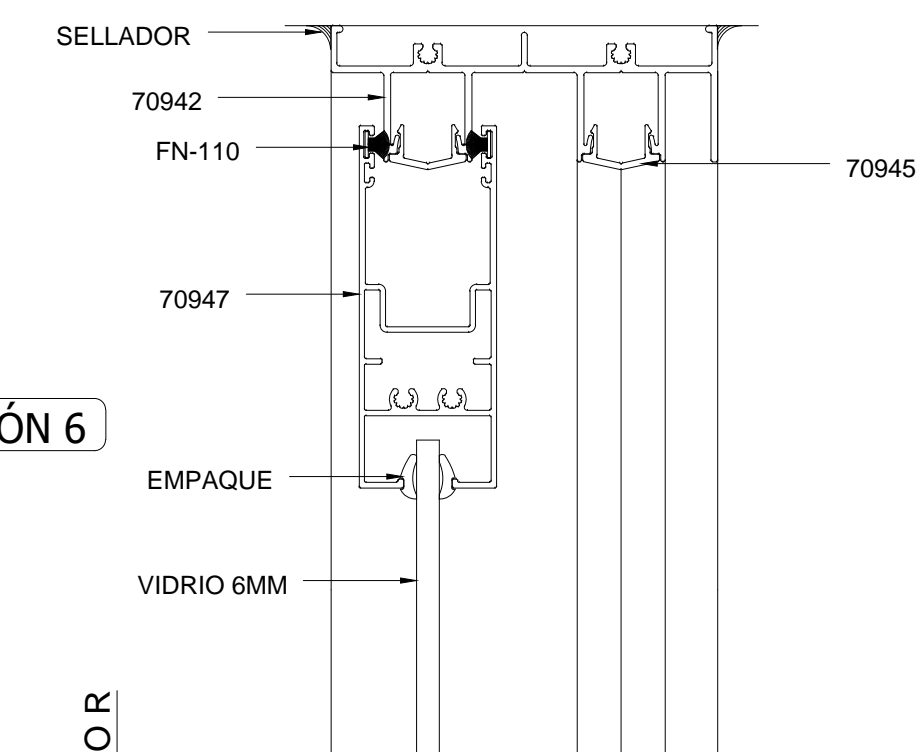

SECCIÓN 6

EXTERIOR

INTERIOR

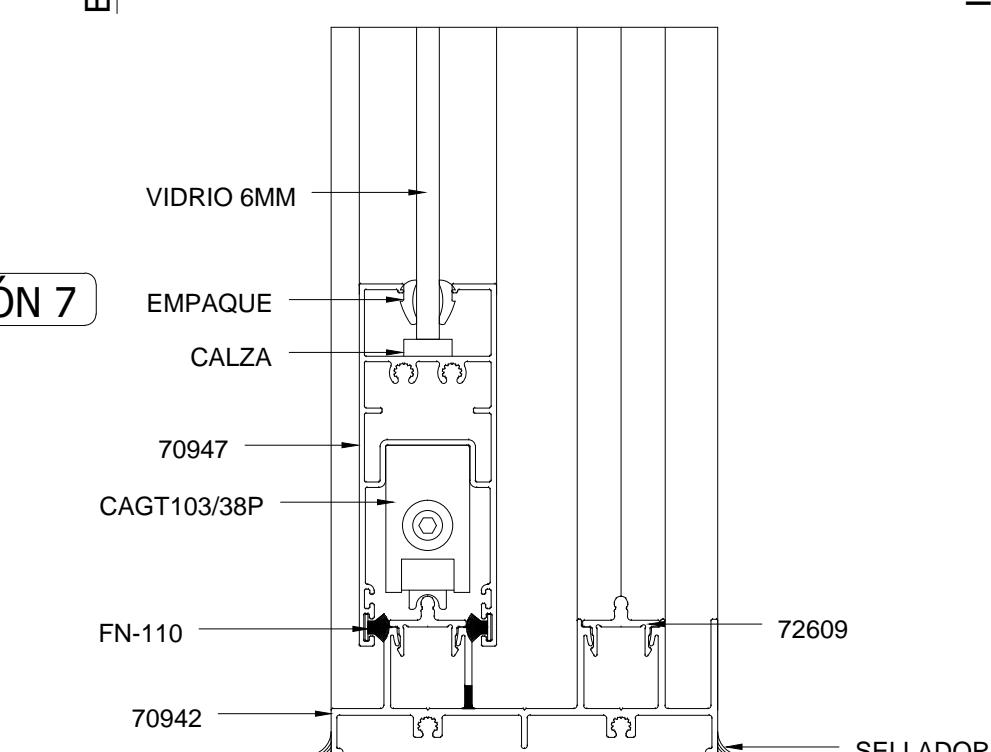

SECCIÓN 7

ESCALA 1:2



T-S100AROB

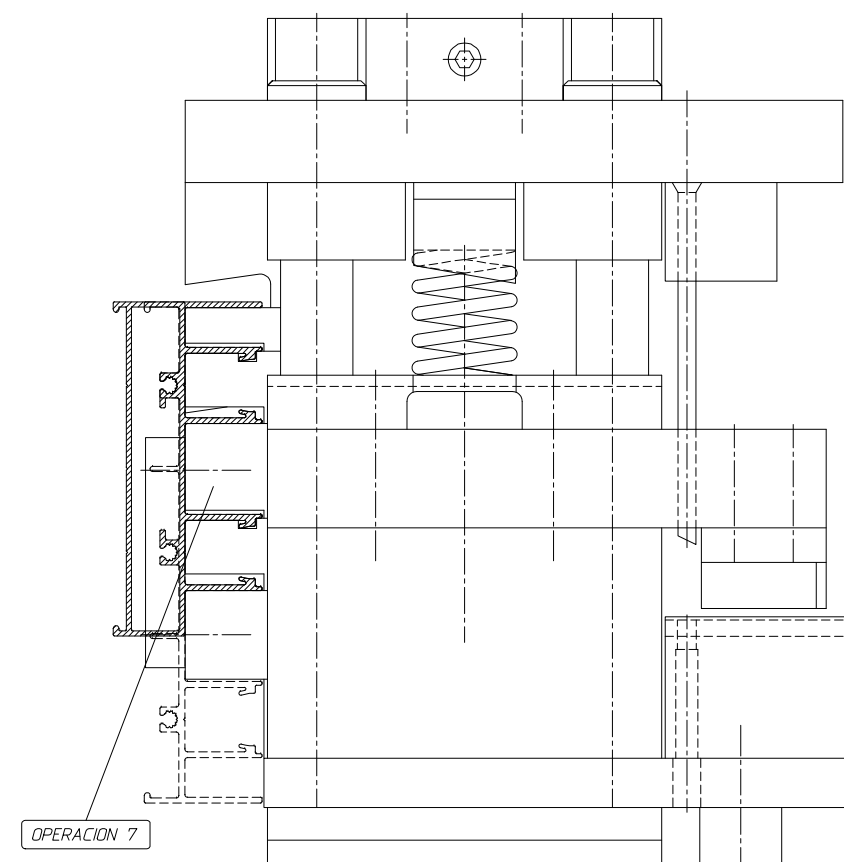
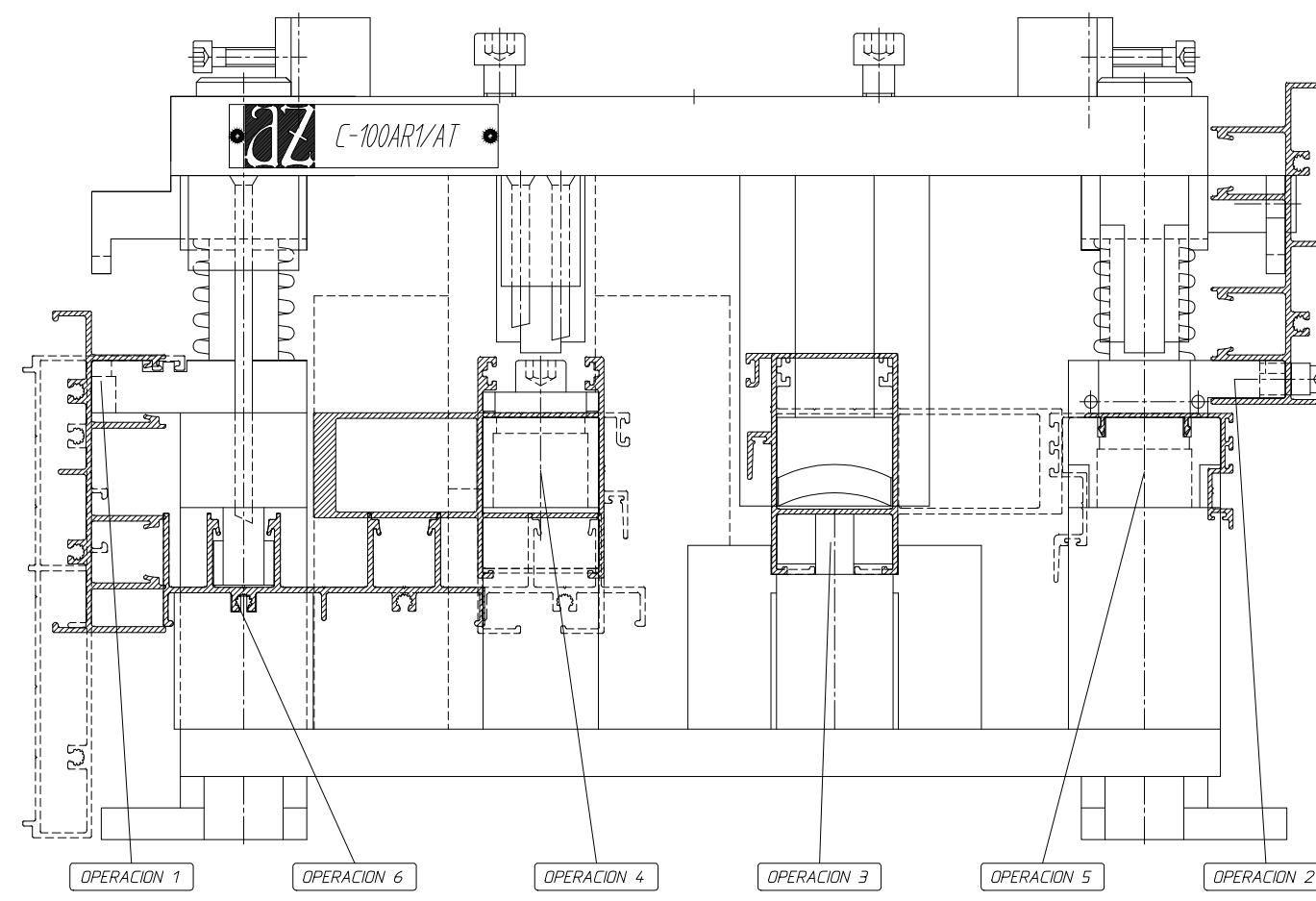

**OPERACION 1 90°/45°**  
**DREN DE PISTA**

- PERFIL 70953 • PERFIL 71207
- PERFIL 70942 • PERFIL 70997
- PERFIL 70943 • PERFIL 70998
- PERFIL 71354 • PERFIL 71251
- PERFIL 71253

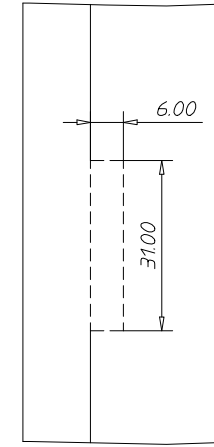
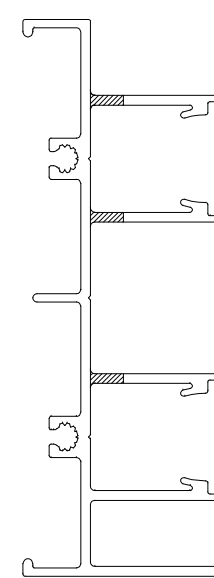

**OPERACION 2 90°/45°**  
**DREN DE CANAL**

- PERFIL 70942 • PERFIL 70997
- PERFIL 70943 • PERFIL 70998

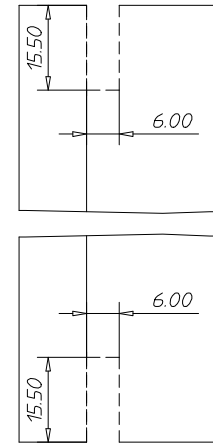
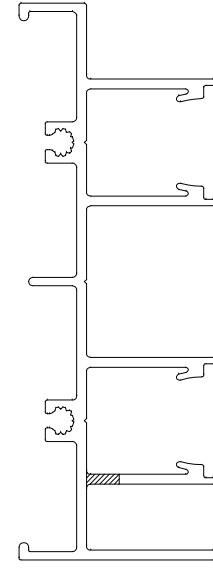

**OPERACION 3 90°**  
**ENCASTRADO**

- PERFIL 70946 • PERFIL 70999
- PERFIL 70957 • PERFIL 71210
- PERFIL 70948 • PERFIL 71206

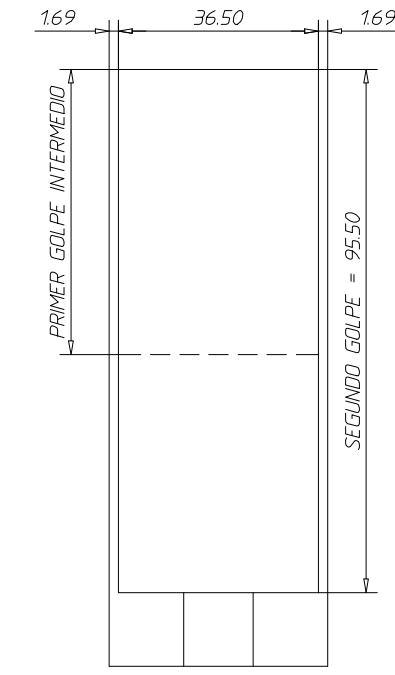
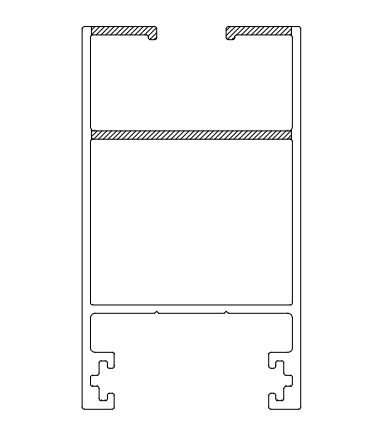

**OPERACION 4 90°**  
**CAJEADO-BARRENOS**

- PERFIL 70946 • PERFIL 70999
- PERFIL 70957 • PERFIL 71210
- PERFIL 70948 • PERFIL 71206
- PERFIL 70950

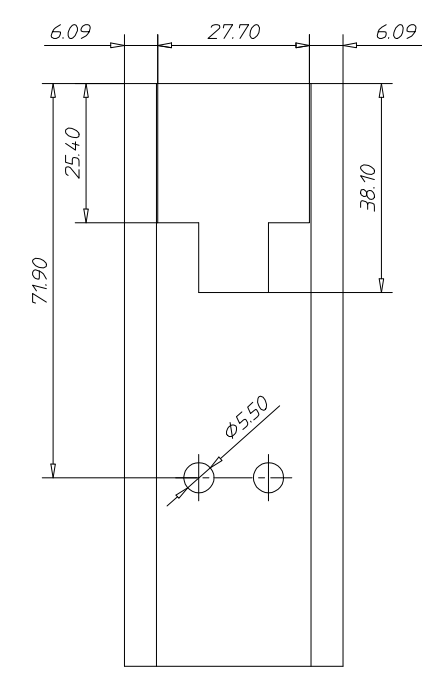
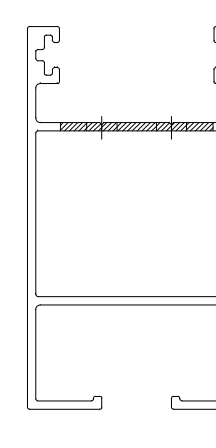

**OPERACION 6 90°**  
**PUNZONADO**

- PERFIL 70953
- PERFIL 70943

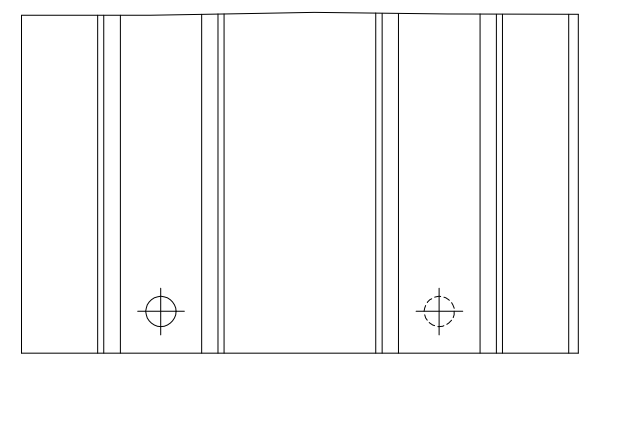
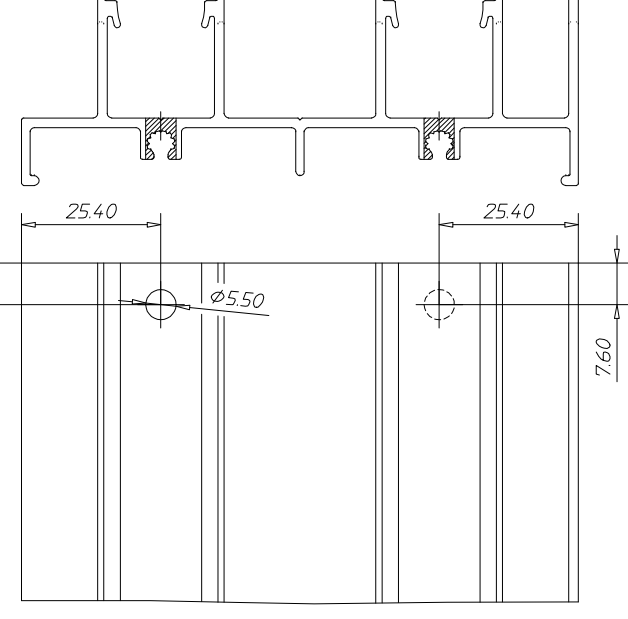

**OPERACION 7 90°**  
**CORTE-ALETAS**

- PERFIL 70953 • PERFIL 71207
- PERFIL 70942 • PERFIL 70997
- PERFIL 70943 • PERFIL 70998

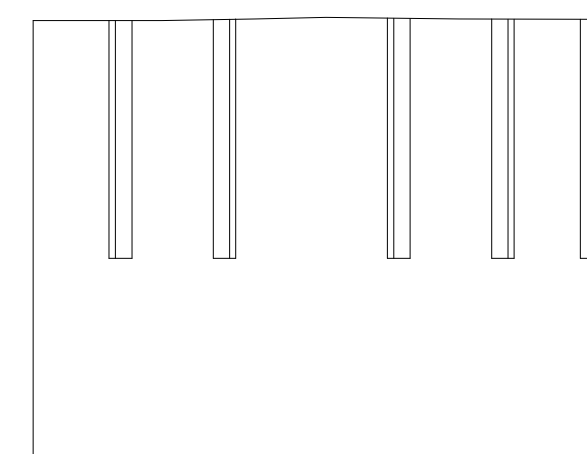
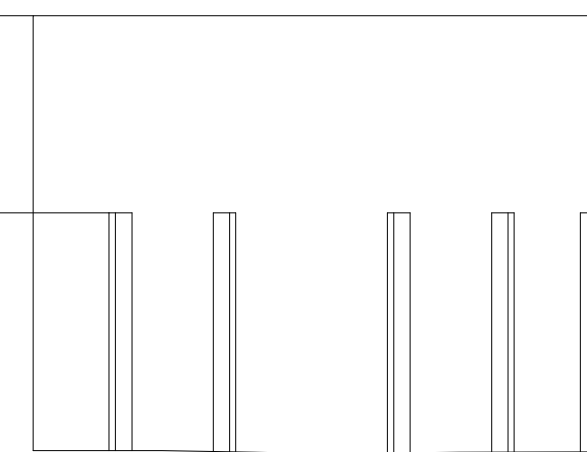
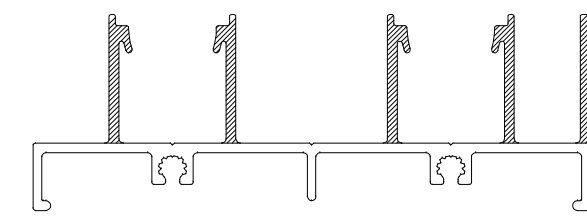

SIN ESCALA

**Operaciones Manuales**  
Serie 100 AR Corrediza

**Broche Embutido**

- PERFIL 70946 • PERFIL 70999
- PERFIL 70957 • PERFIL 71210
- PERFIL 70948 • PERFIL 71206
- PERFIL 70950

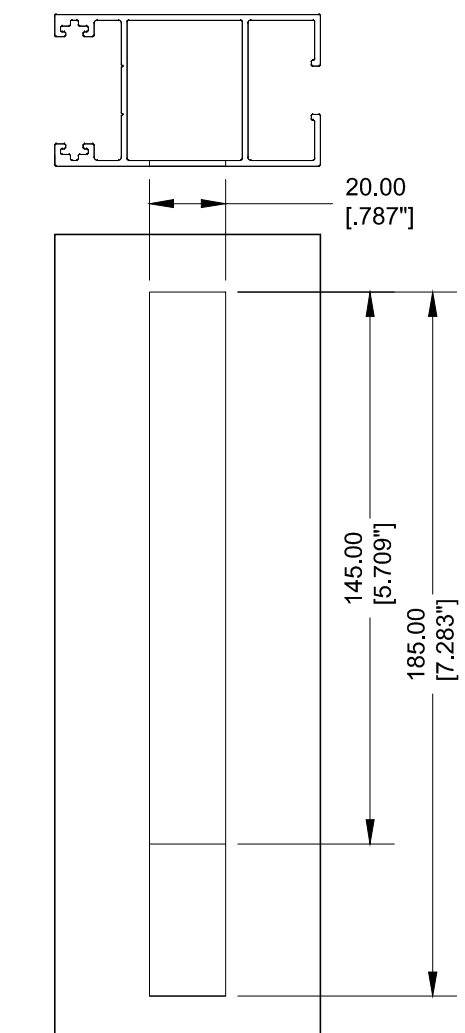

**Paso de Pista**

- PERFIL 70944

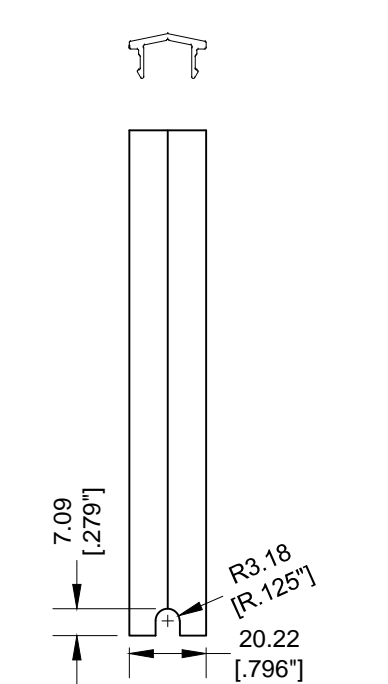

Realizar operación únicamente en la parte interior

SIN ESCALA

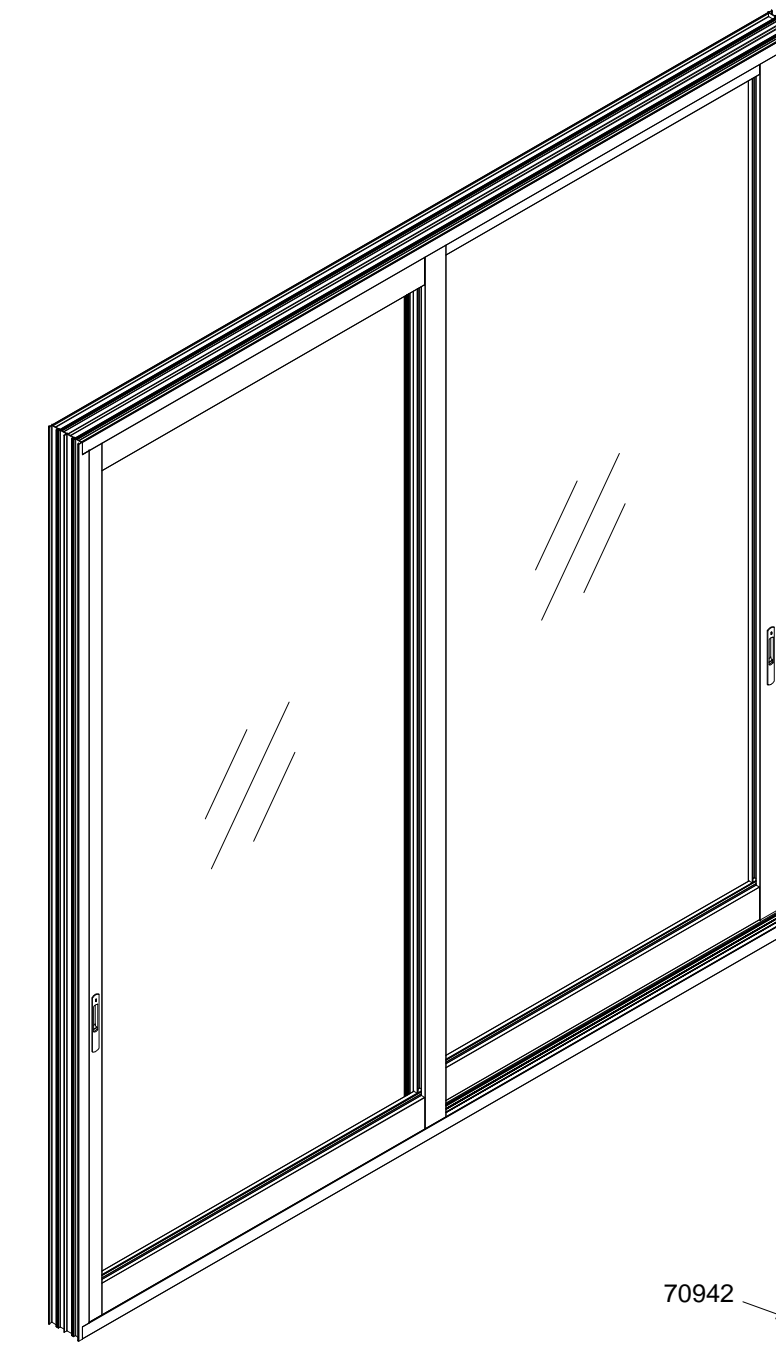

PUERTA CORREDIZA XX		
CLAVE	DESCRIPCIÓN	PIEZAS
CV-S100AR	CORTAVIENTOS S-100AR	2
CH-S100AR2	CANDADO DE HOJA S-100 AR	8
TT-S100AR2	TAPA TRASLAPE S-100 AR	4
GENÉRICO	CALZA DE NEOPRENO	4
EH-S100AR2	EMPAQUE DE HERMETICIDAD	4
CAGT103/3P	CARETILLA PAROSE S-100	4
FN-604C	CONTRA	2
FN-628	GANCIO	2
FN-002	KIT ANTI FALSA MANIOBRA	2
FN-550	BROCHE EMBUTIDO FAPM OLE TOP	2
FN-110	FELPA	4L X 6H
GENÉRICO	EMPAQUE	2L X 4H
E-2613	EMPAQUE HONGO CON ALETA	2H
GENÉRICO	TORNILLO 1   #10	24
GENÉRICO	TORNILLO 1   #8	8



TABLA DE DESCUENTOS SOLUCION XO o XX			
CLAVE	DESCRIPCIÓN	No. DE PIEZAS	CORTE Y DESCUENTO
70942	JAMBA	2	H
70942	RIEL	2	L - 25
70947	ZOCLO	4	L/2 - 13
70946	CERCO	2	H - 57
70948	TRASLAPE	2	H - 57
70944	PISTA 2 AGUAS V	4	H - 62
70944	PISTA 2 AGUAS H	2	L - 52
72609	PISTA DE GOTA	2	L - 26
VIDRIO	L	2	L/2 - 104
	H		H-219

L= ANCHO DE VENTANA  
H= ALTO DE VENTANA  
DESCUENTOS EN MM.



Sistema de Drenado  
Serie 100 AR Corrediza

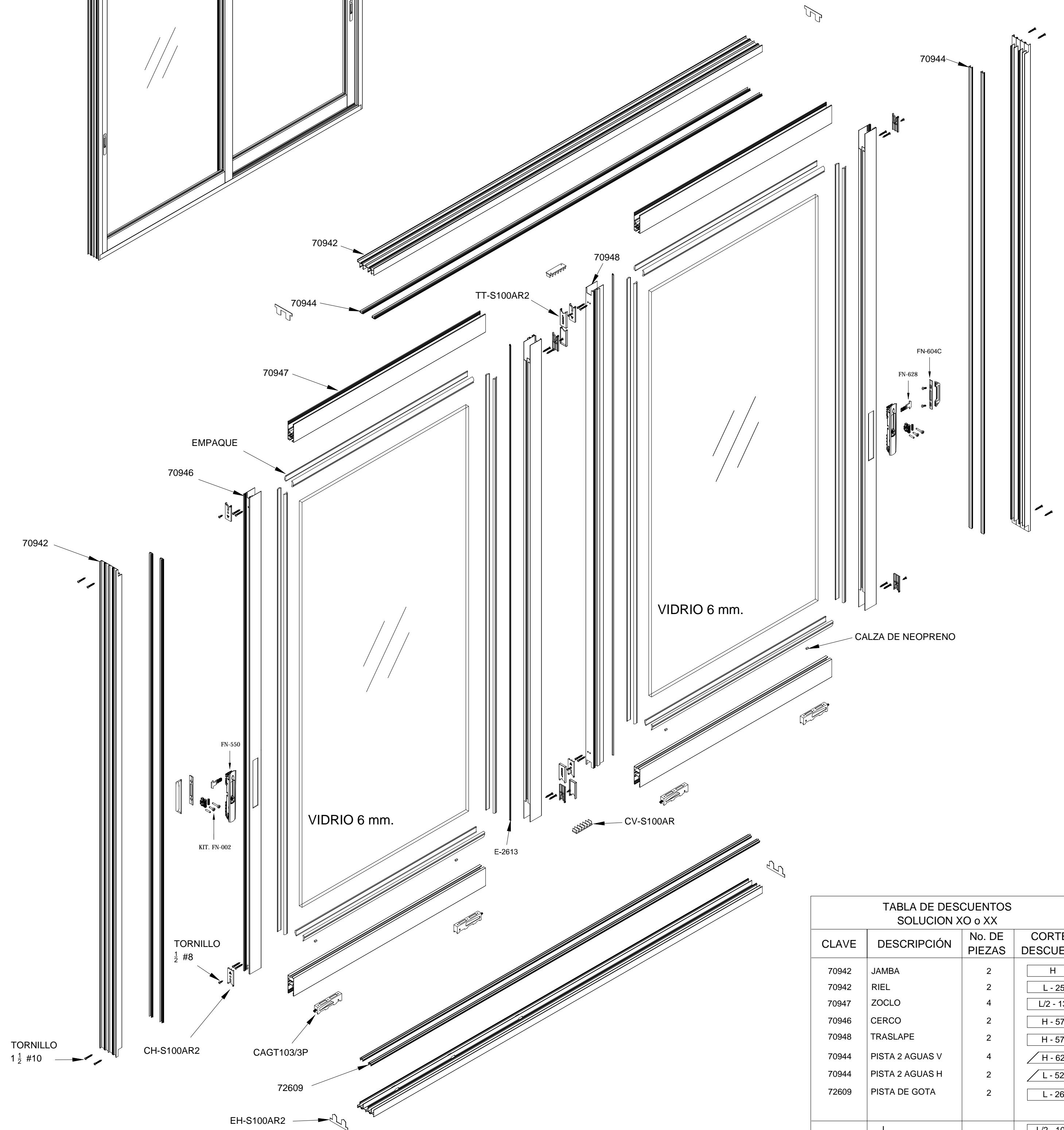
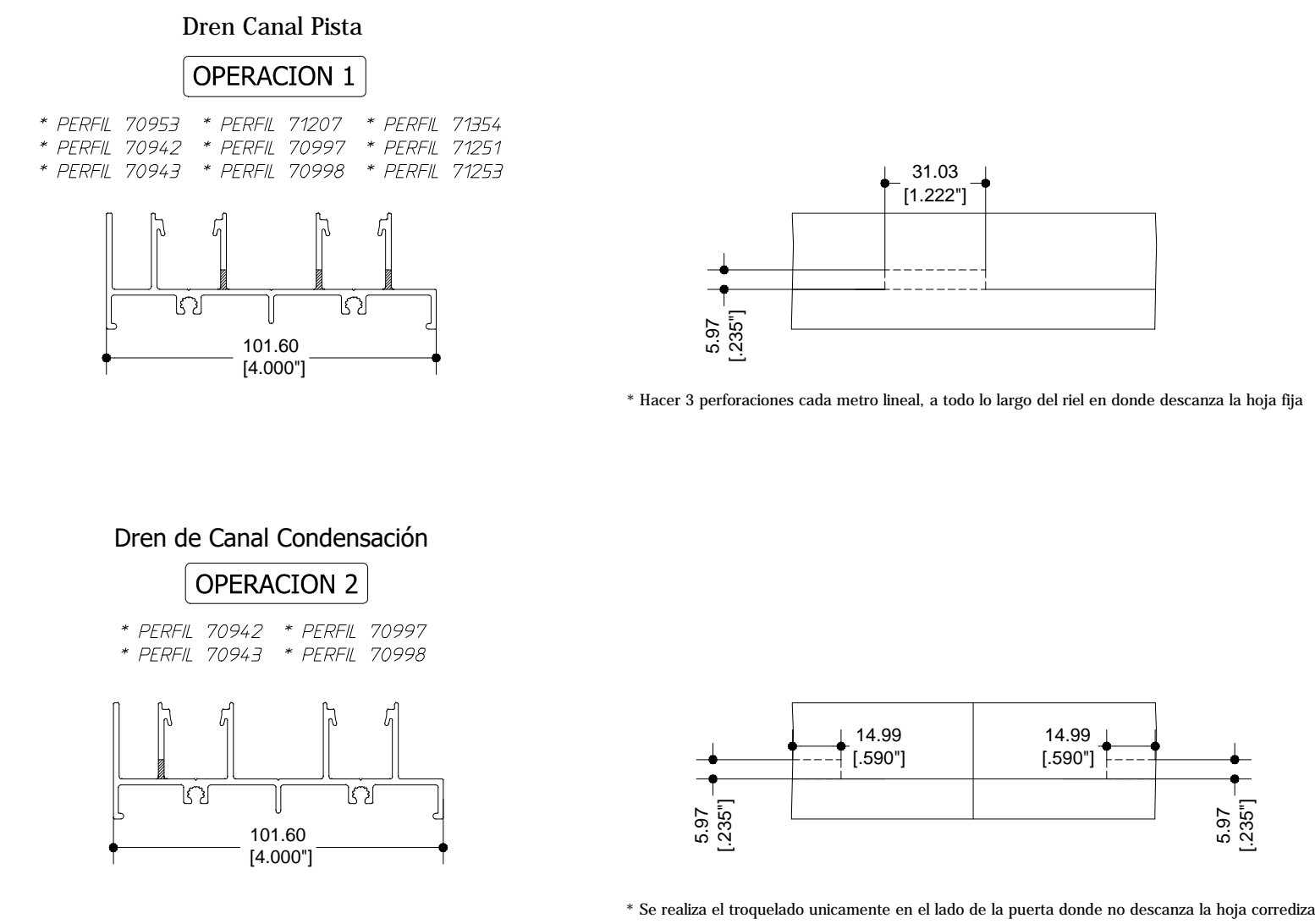

ESCALA 1:2



Sistema de Drenado  
Serie 100 AR Corrediza

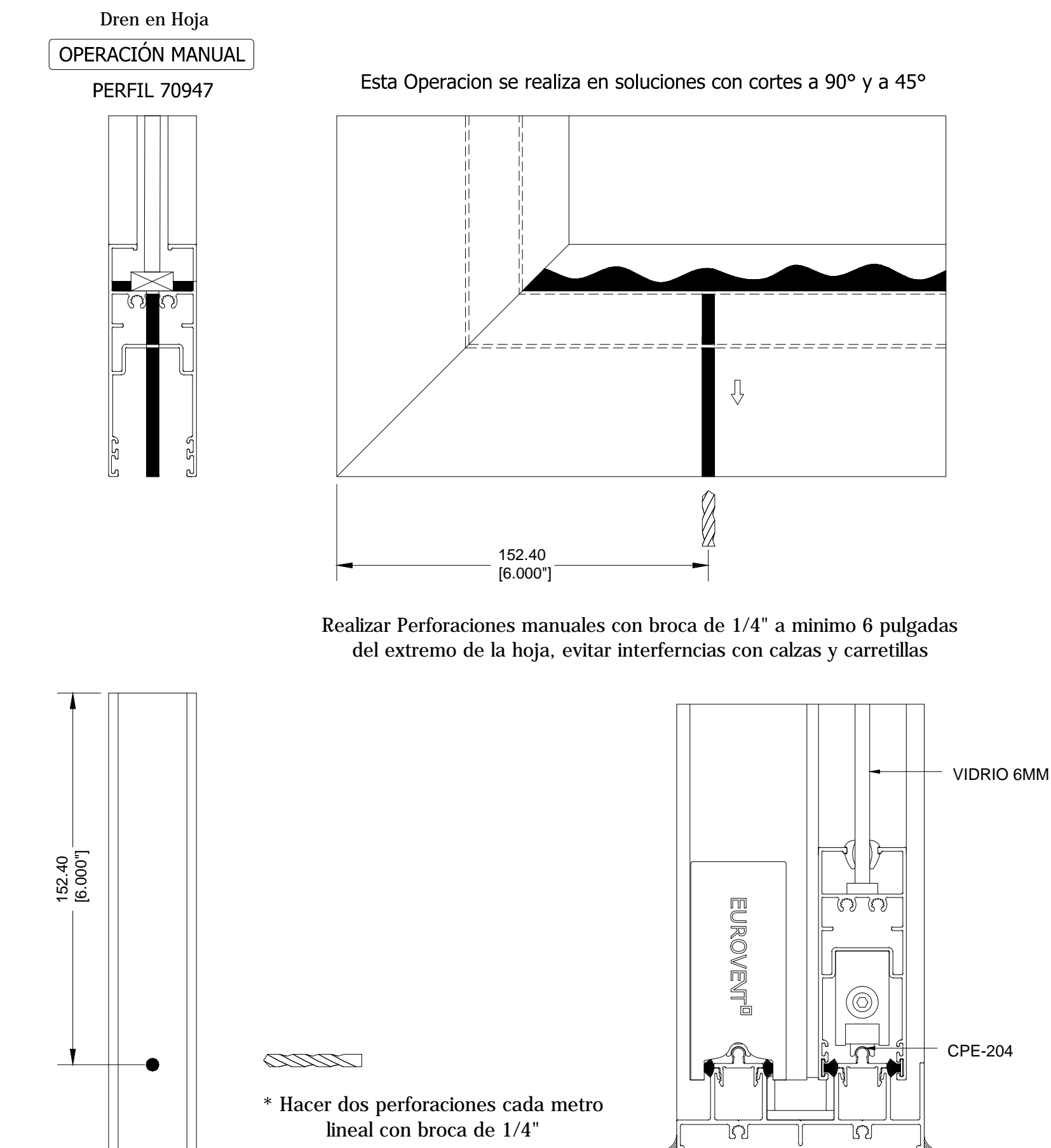

Posición de hojas

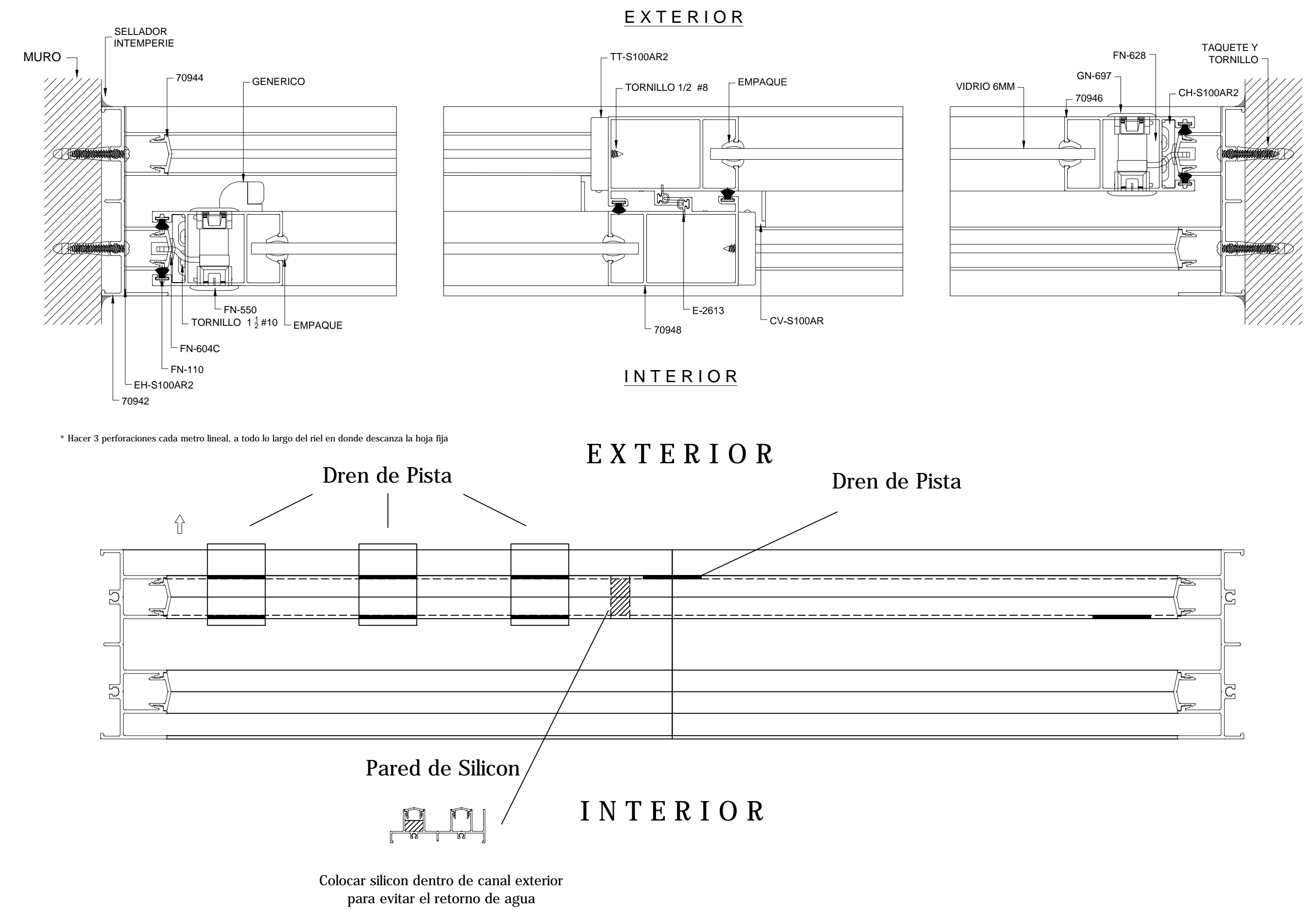

Sistema de Drenado  
Serie 100 AR Corrediza

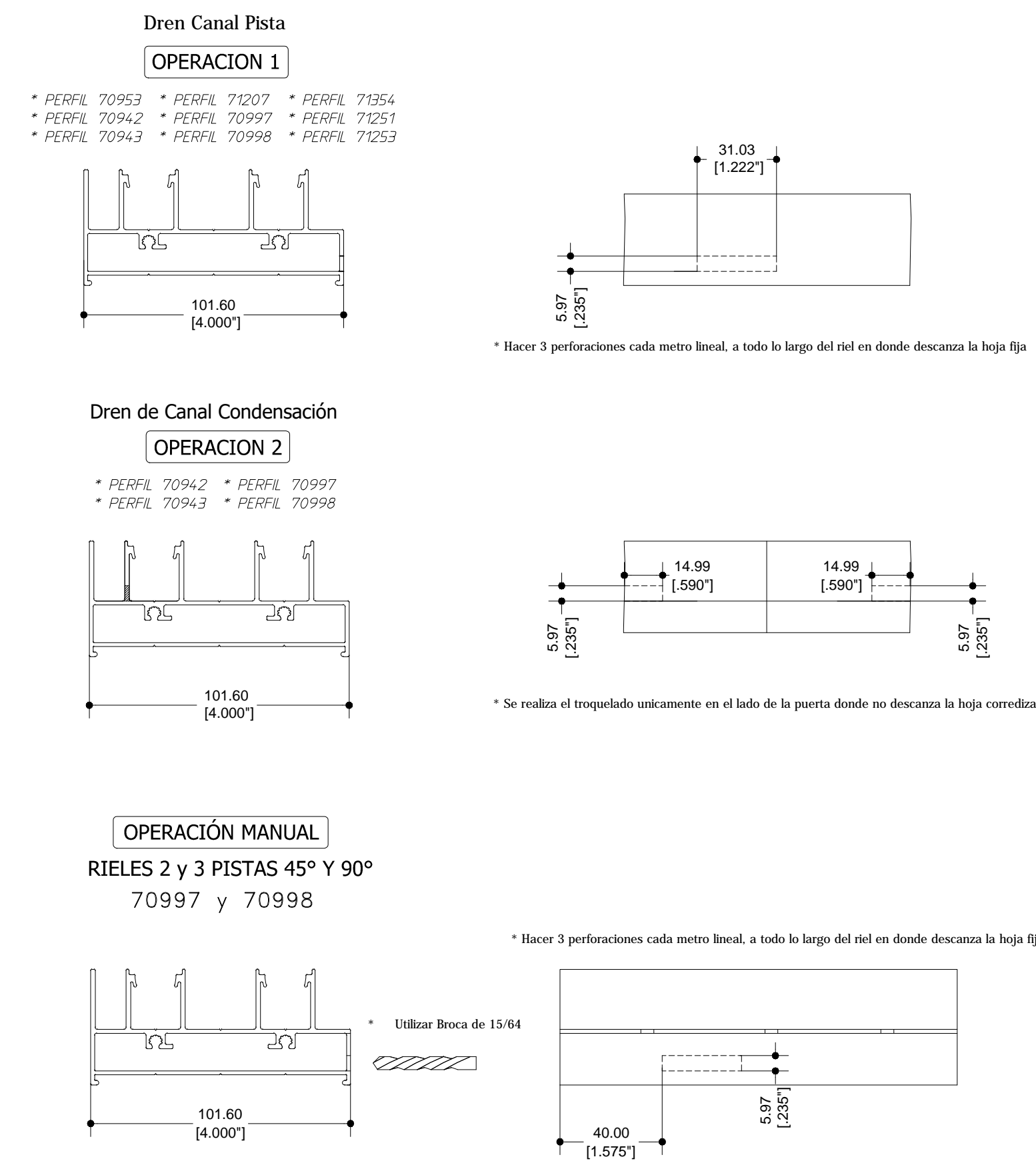

ESCALA 1:2



Sistema de Drenado  
Serie 100 AR Corrediza

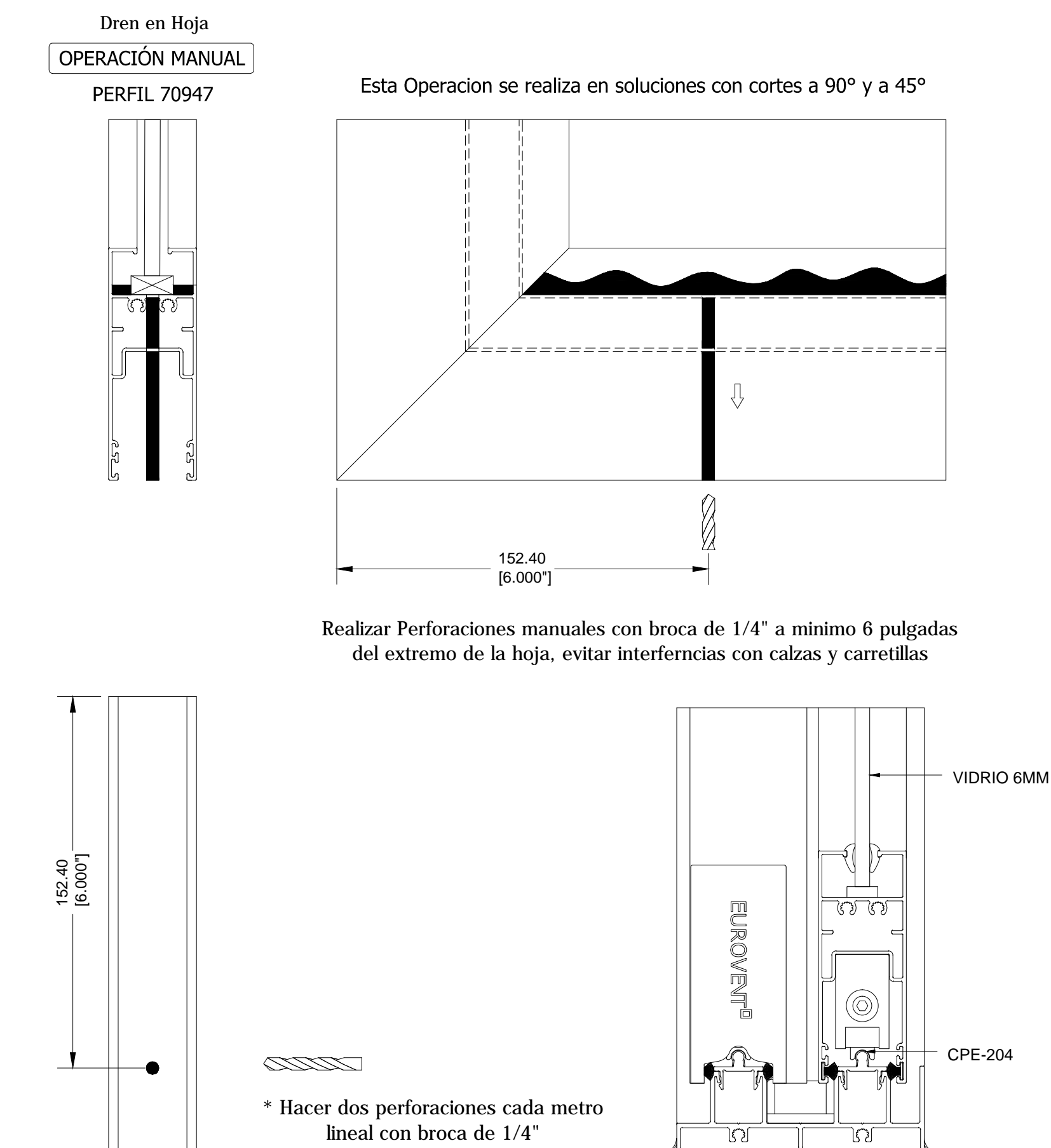

Posición de hojas

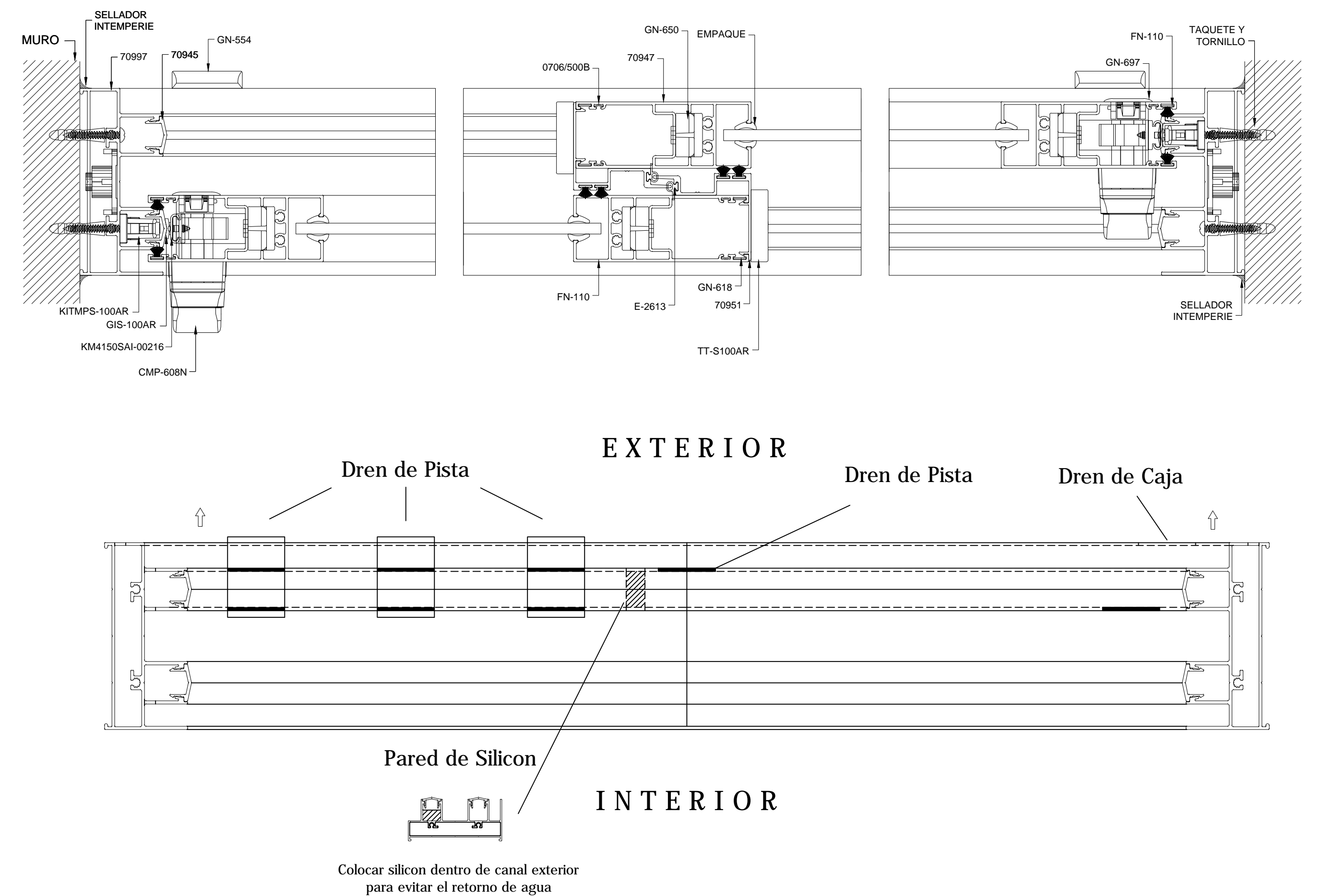

Sección con Fijo  
Serie 100 AR Corrediza

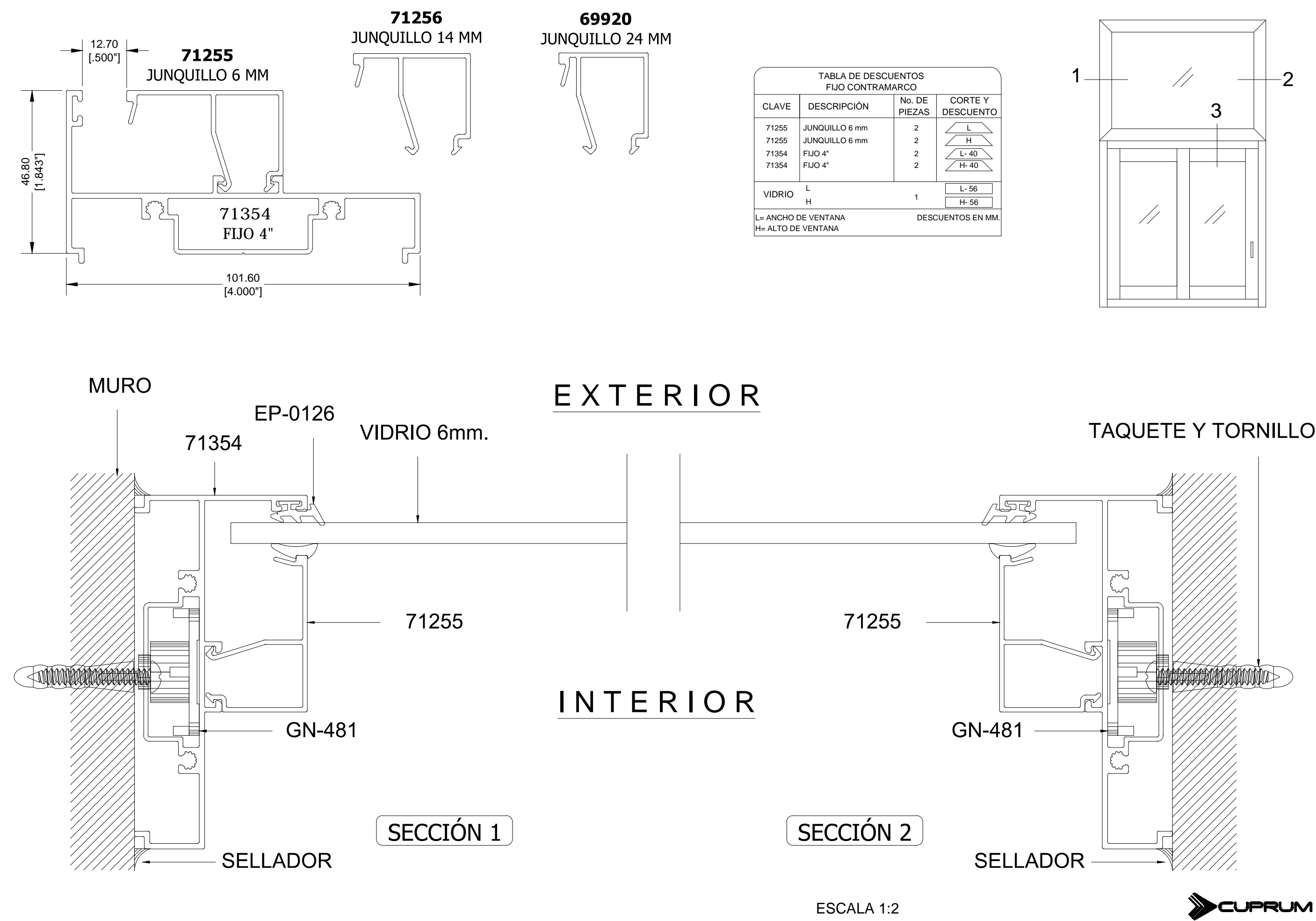

Sección con Fijo  
Serie AR 100 Corrediza

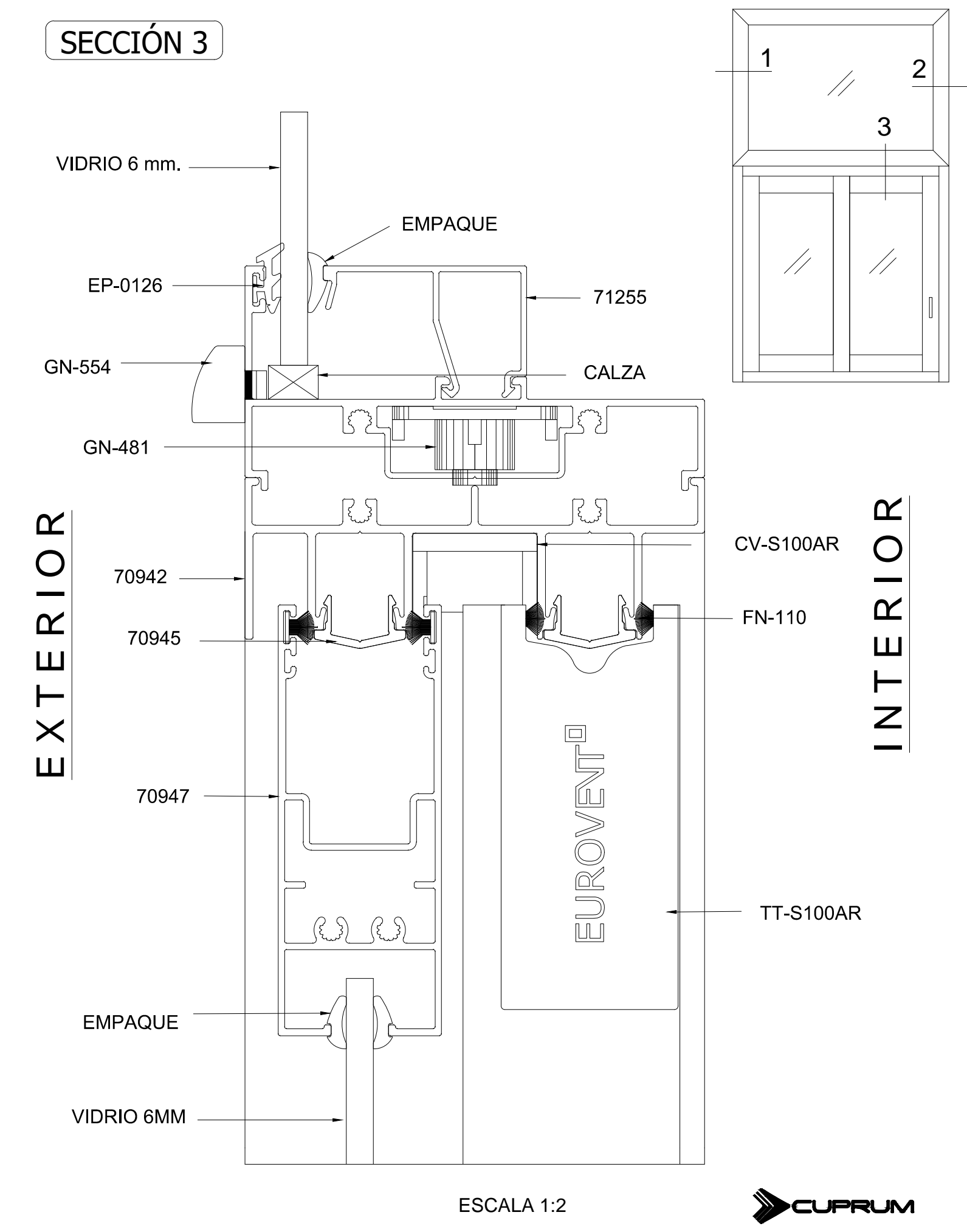

Sección con Fijo  
Serie 100 AR Corrediza

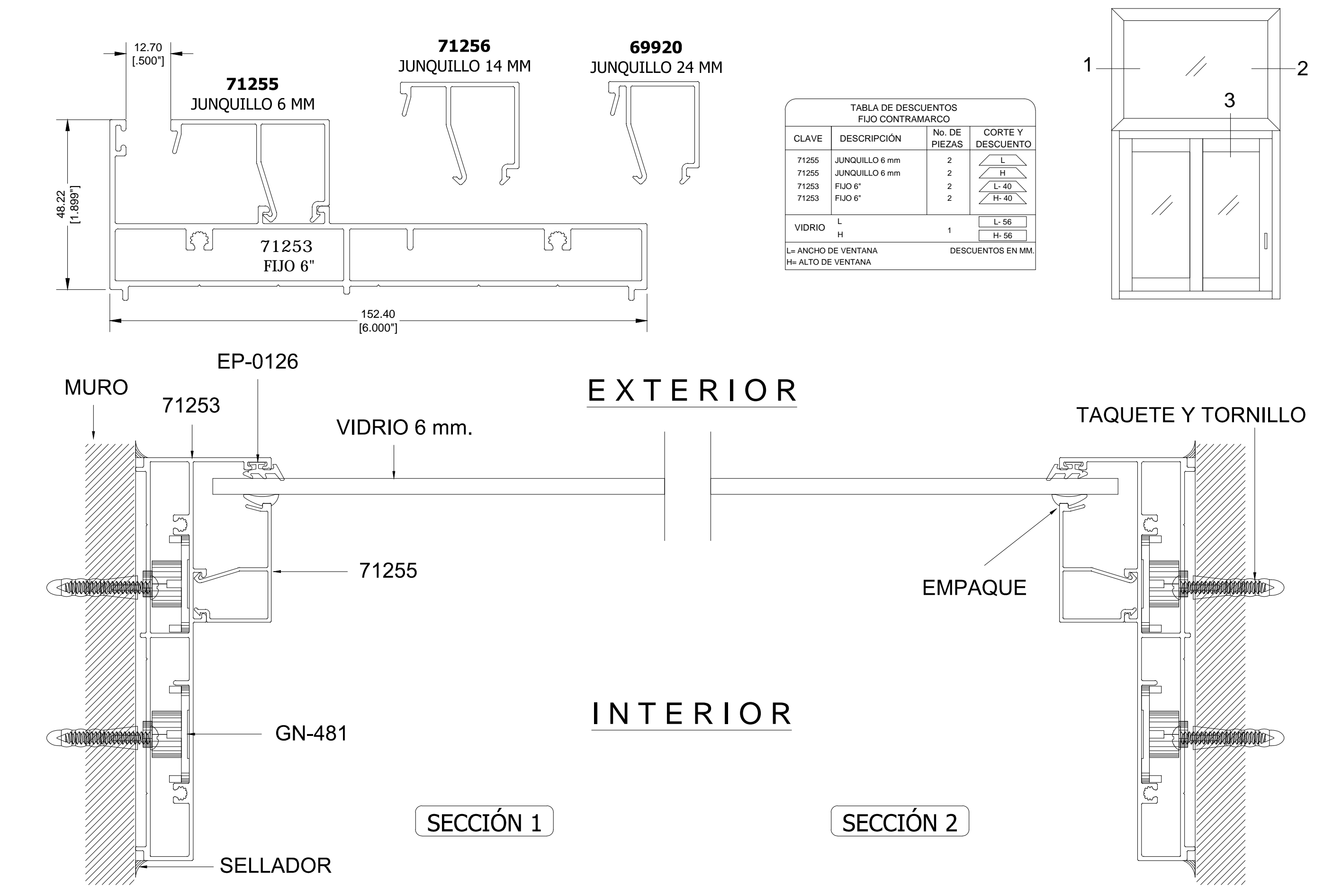

Sección con Fijo  
Serie 100 AR Corrediza

