

# EUROVENT

CLASSIC

The logo for CUPRUM features a stylized blue arrow pointing to the right, composed of three parallel lines of varying lengths, followed by the word "CUPRUM" in a bold, grey, sans-serif font.

CORREDIZA 70

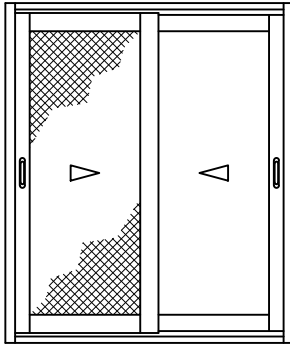

X X

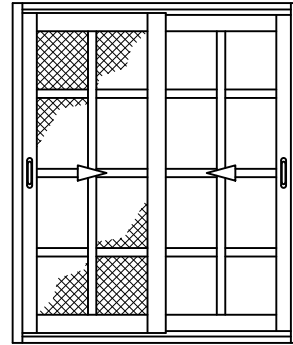

X X

EUROVENT

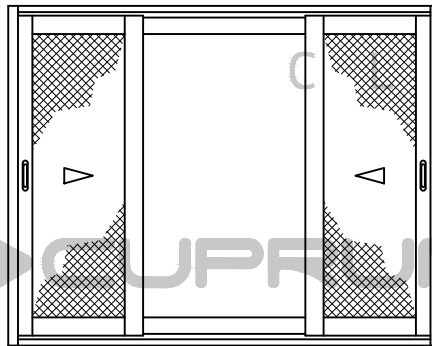

X O X

CLASSIC  
SERIE  
S70  
CORREDIZA

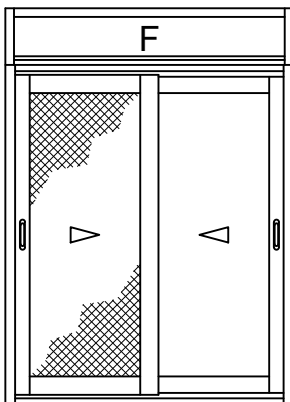

X X

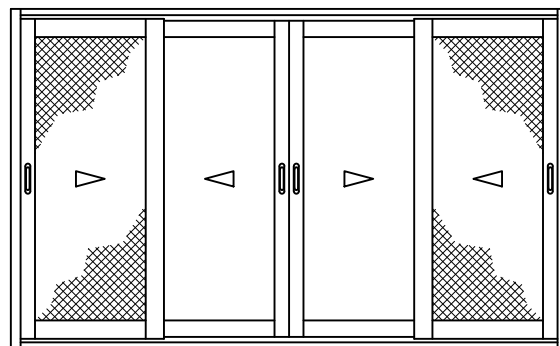

X X X X

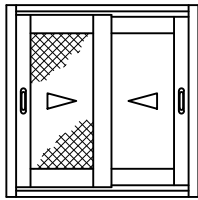

X X

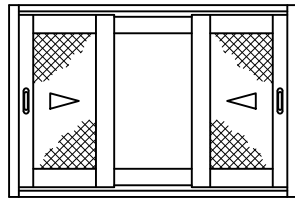

X O X

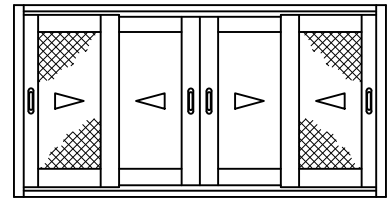

X X X X

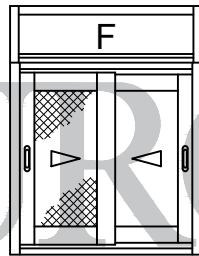

X X

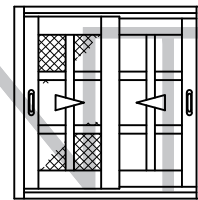

X X

CLASSIC  
SERIE

S70



CORREDIZA

EUROVENT

CLASSIC

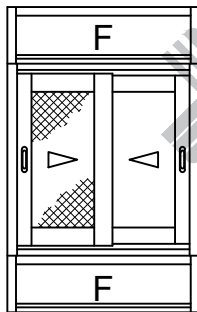

X X

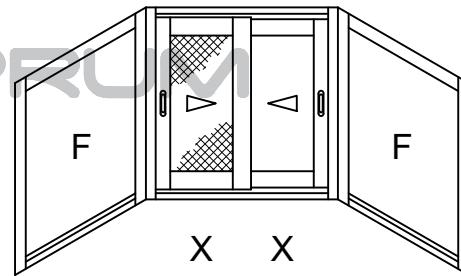

X X

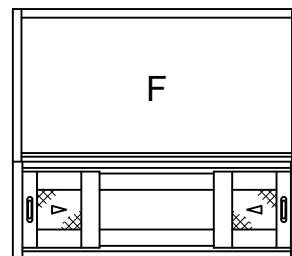
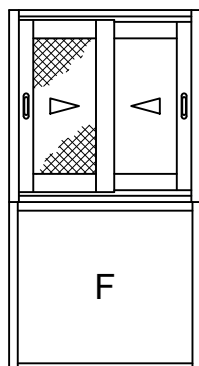

X O X

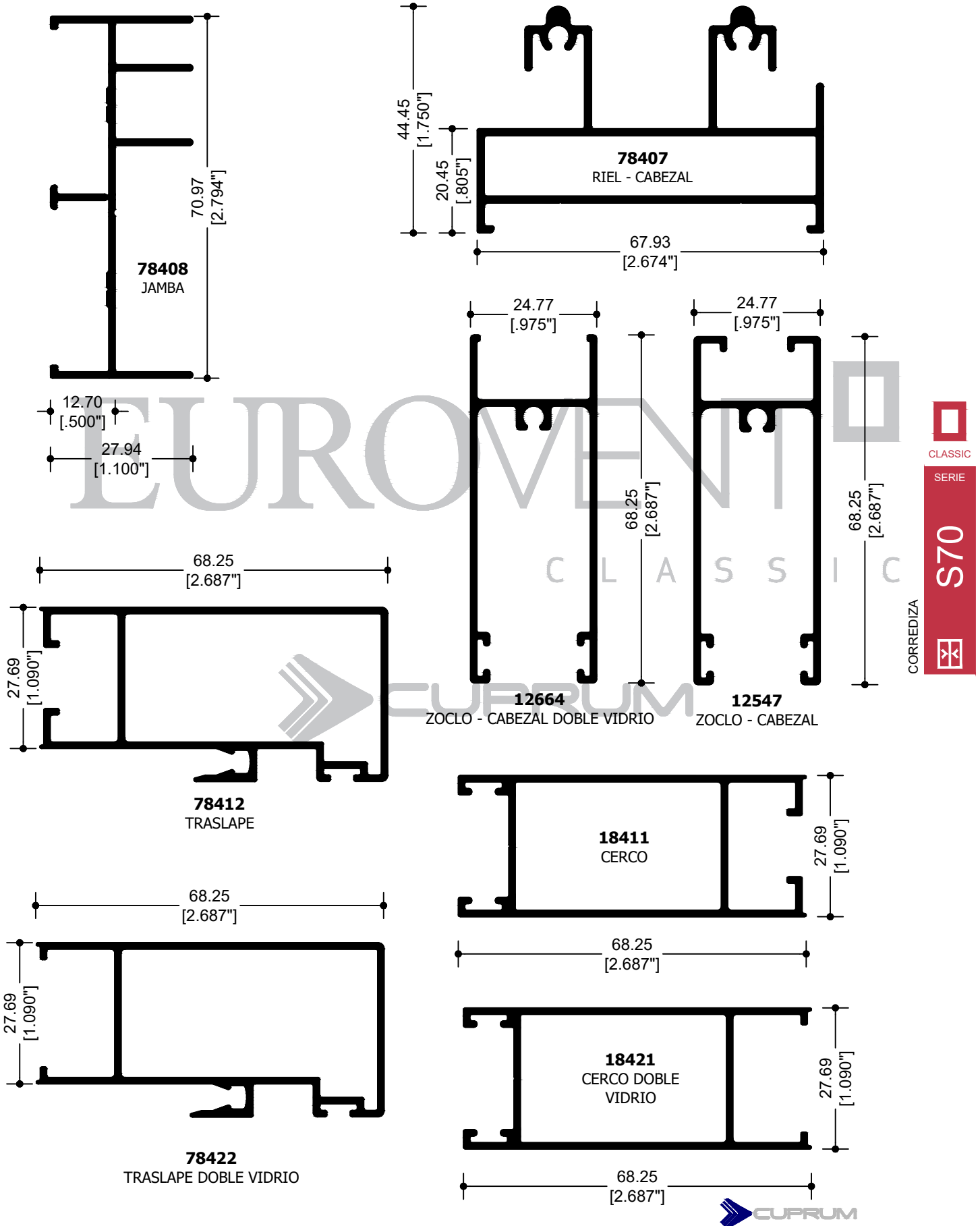

CLASSIC  
SERIE  
**S70**  
CORREDIZA

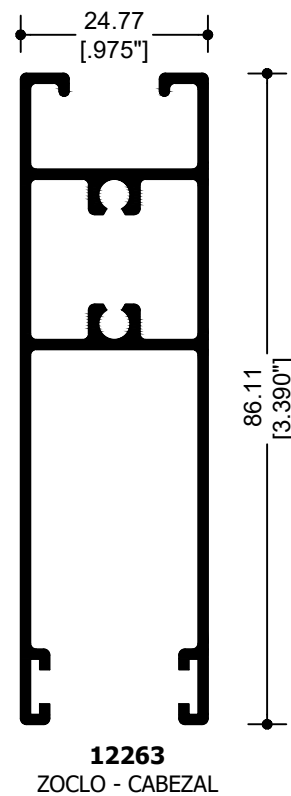
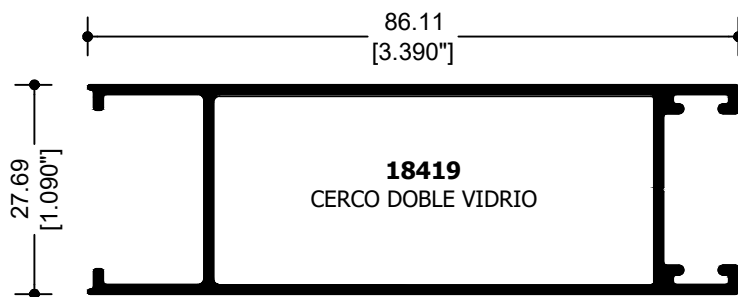
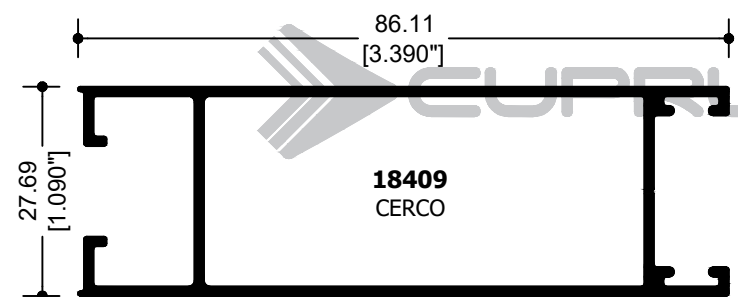
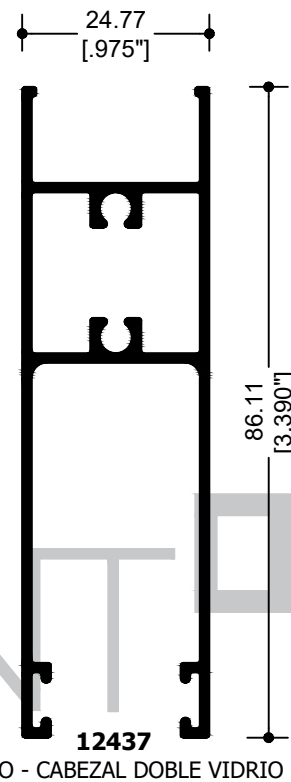
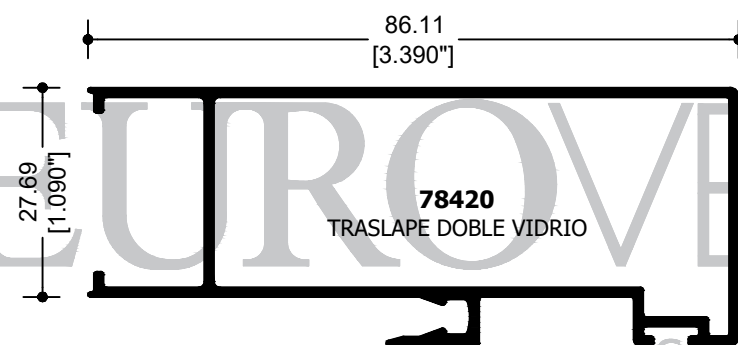
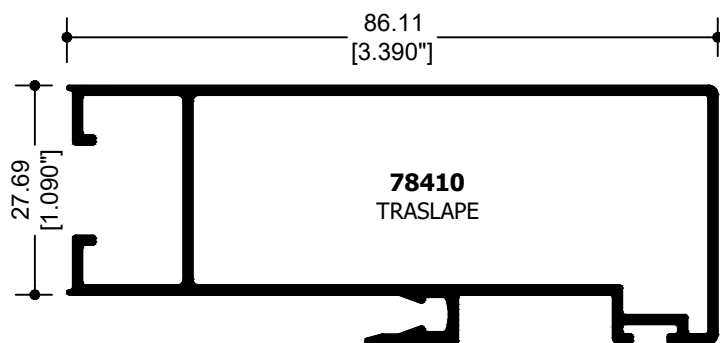

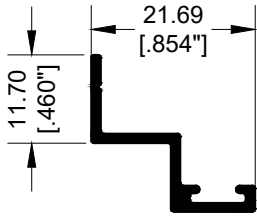

**50701**  
ADAPTADOR  
OXXO

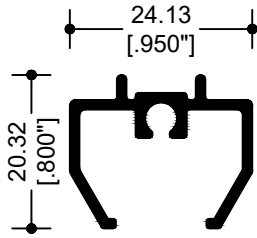

**14702**  
PERFIL P/CUADRÍCULA

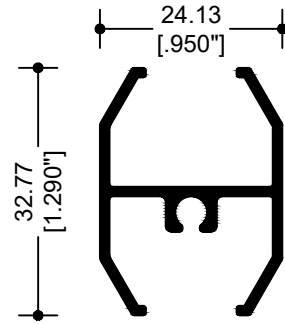

**14918**  
PERFIL P/CUADRÍCULA

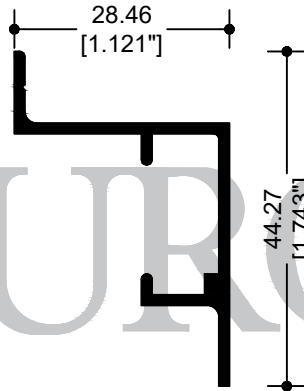

**11409**  
CABEZAL MOSQUITERO

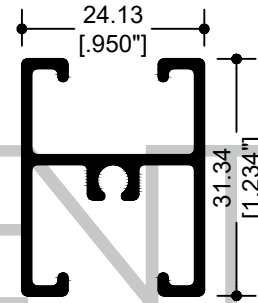

**12456**  
INTERMEDIO

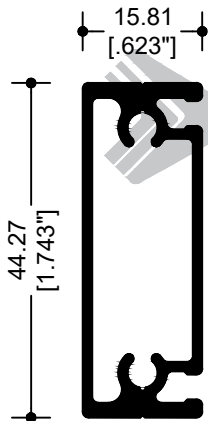

**11411**  
MOSQUITERO

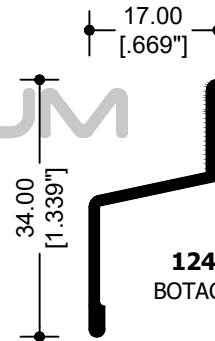

**12428**  
BOTAGUAS

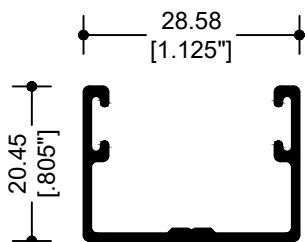

**18413**  
GUÍA INFERIOR

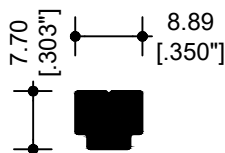

**14412**  
CONECTOR P/REFUERZO

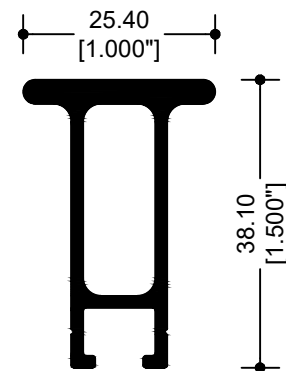

**14411**  
REFUERZO 1 1/2"

EUROVENT CLASSIC

C L A S S I C

CLASSIC  
SERIE  
**S70**  
CORREDIZA

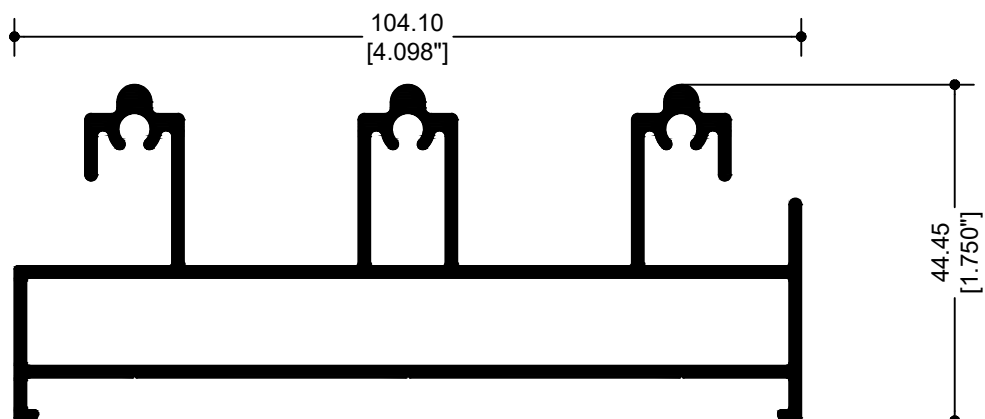

**72373**  
RIEL TRIPLE

CLASSIC  
SERIE  
**S70**  
CORREDIZA

EUROVENT<sup>®</sup>  
CLASSIC

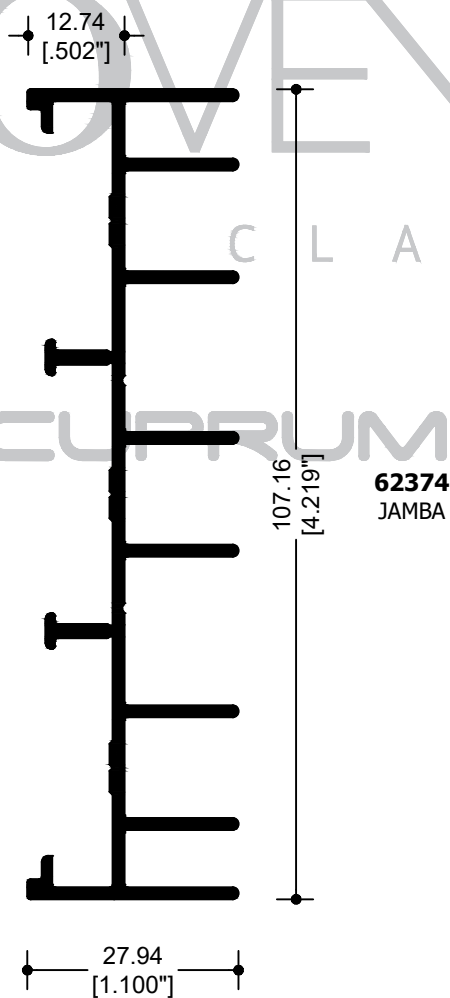

**62374**  
JAMBA

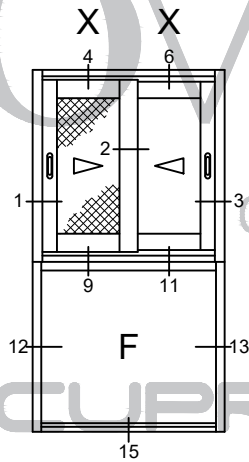
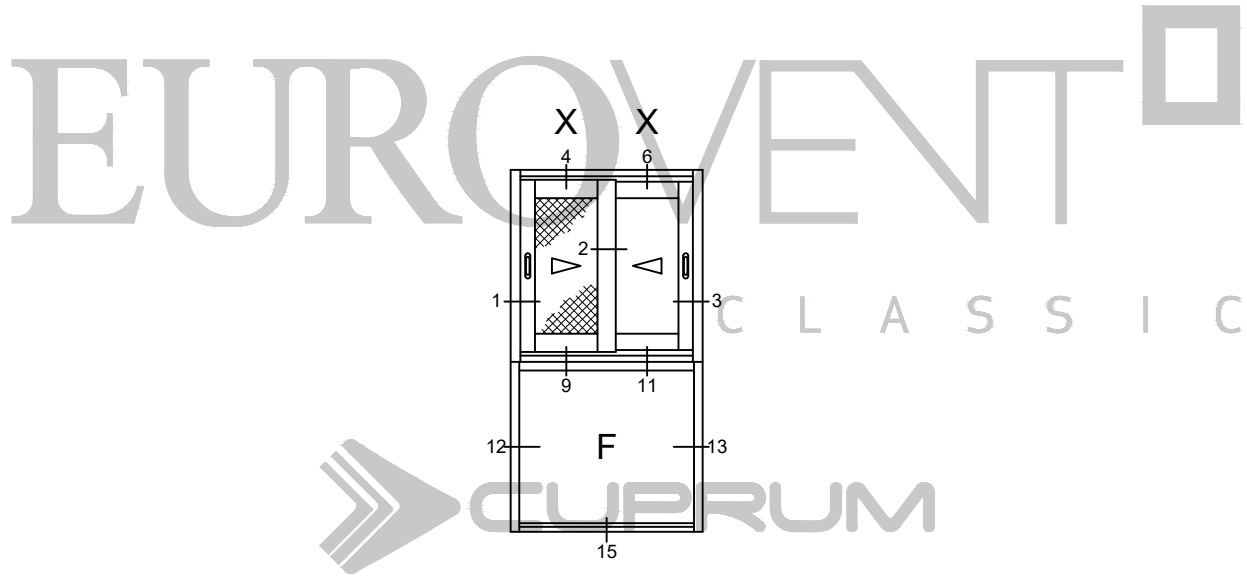
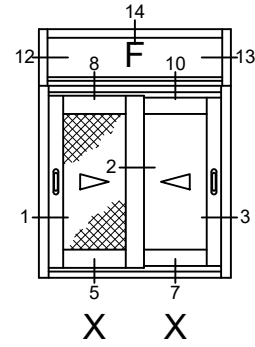
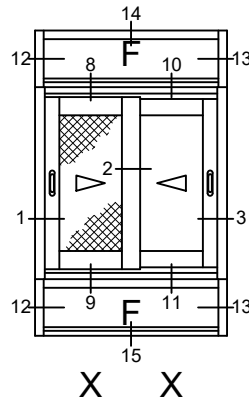
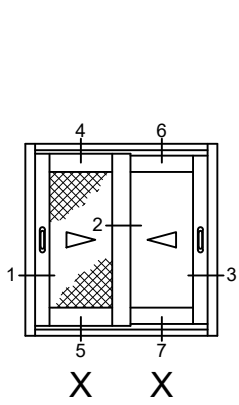

  
 CLASSIC  
 SERIE  
**S70**  
  
 CORREDIZA

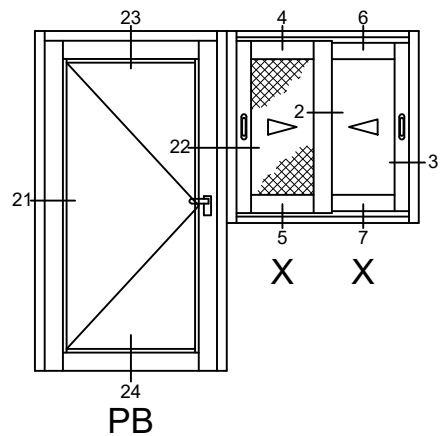
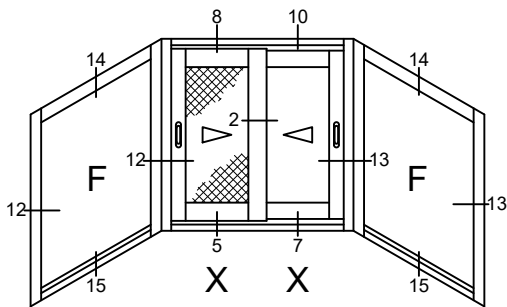



# VENTANA CORREDIZA SERIE 70 - CORTES SECCIONALES EUROVENT<sup>®</sup>

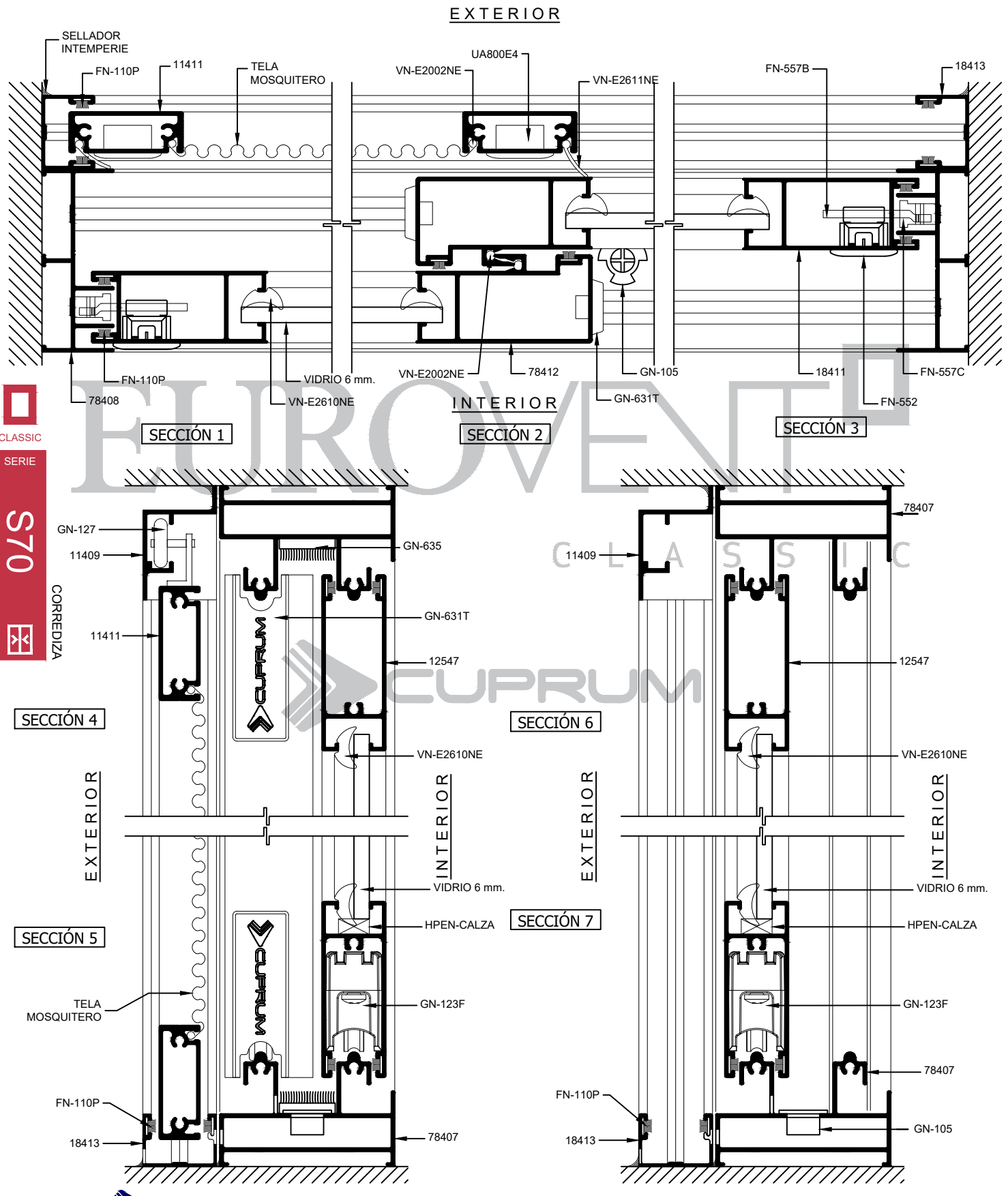

 CLASSIC  
SERIE  
**S70**  
CORREDIZA

# EUROVENT VENTANA CORREDIZA SERIE 70 - CORTES SECCIONALES

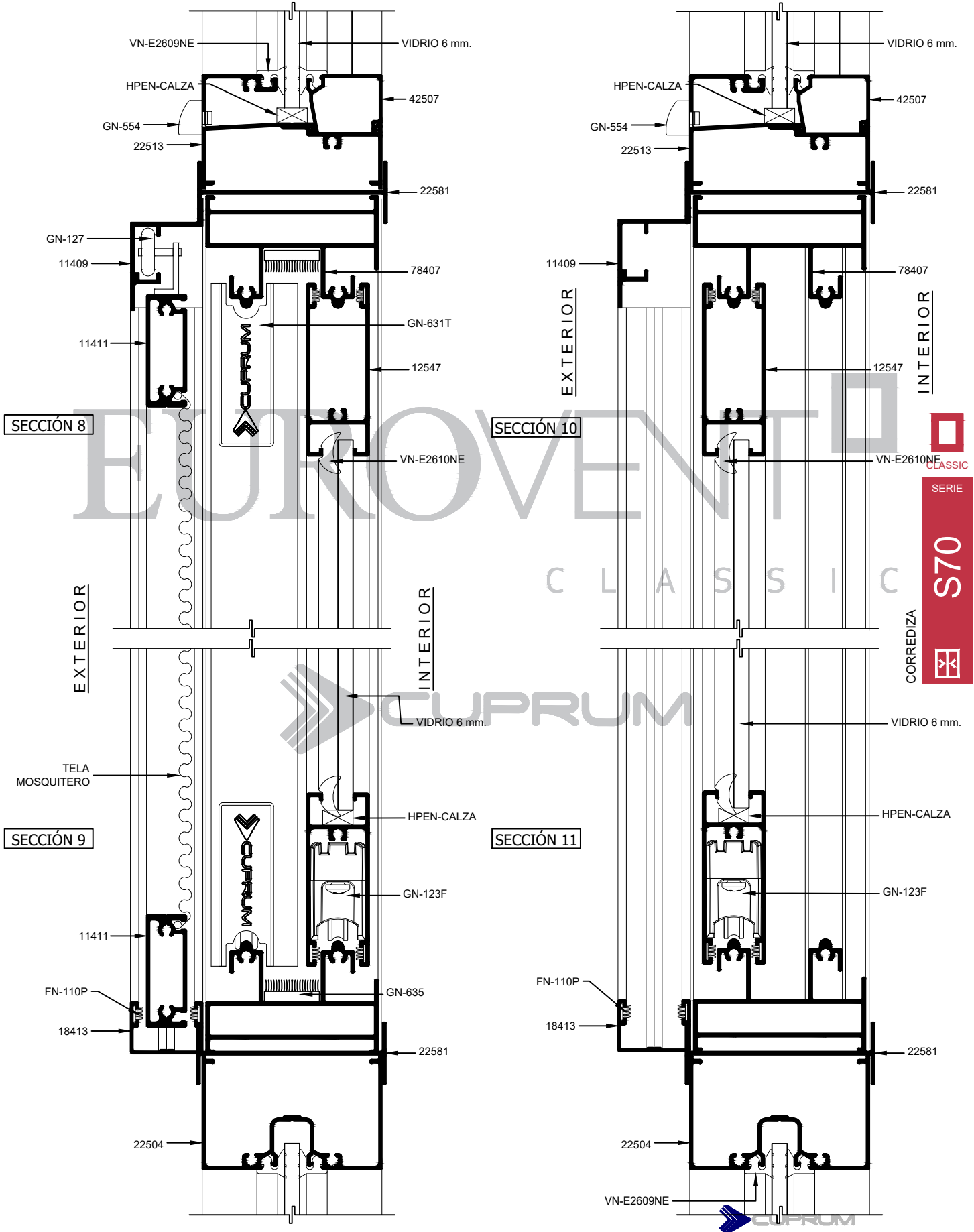

  
 CLASSIC  
 SERIE  
**S70**  
 CORREDIZA

# VENTANA CORREDIZA SERIE 70 - CORTES SECCIONALES EUROVENT<sup>®</sup>

CLASSIC  
SERIE

S70



CORREDIZA

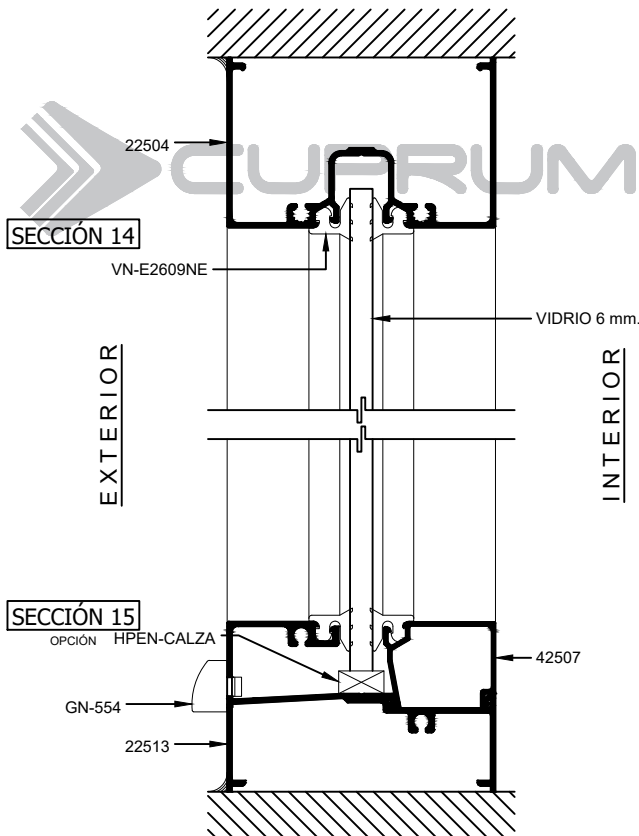
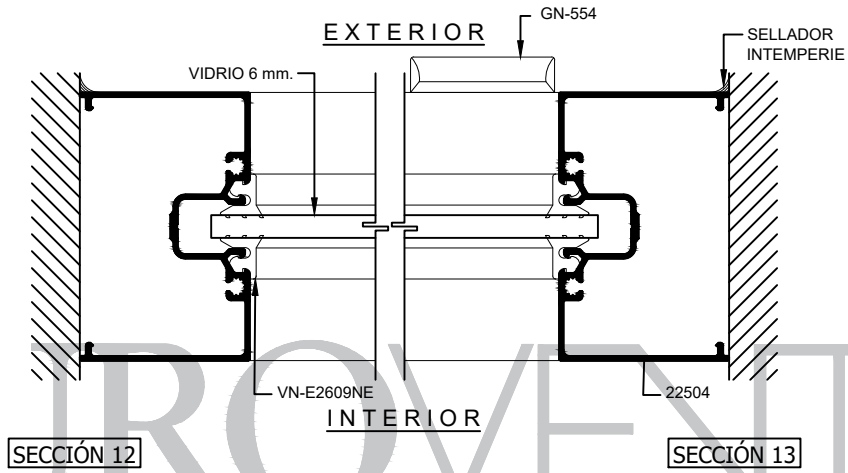

# EUROVENT<sup>®</sup> VENTANA CORREDIZA SERIE 70 - CORTES SECCIONALES

EXTERIOR

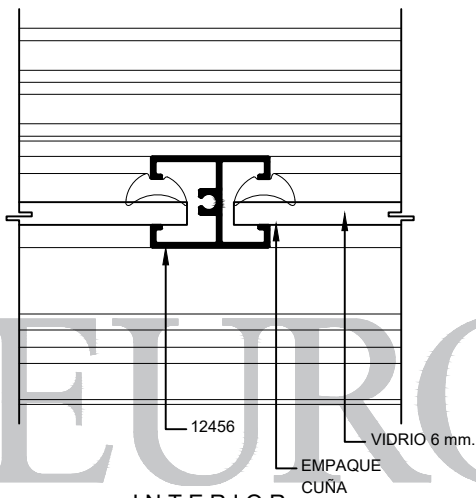

INTERIOR

SECCIÓN 17

EXTERIOR

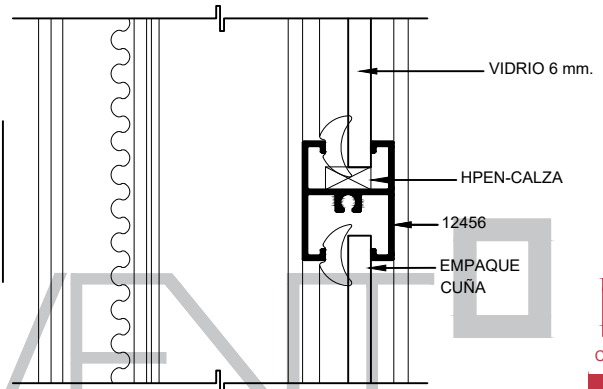

INTERIOR

SECCIÓN 18

C L A S S I C

CLASSIC  
SERIE  
**S70**  
CORREDIZA

EXTERIOR

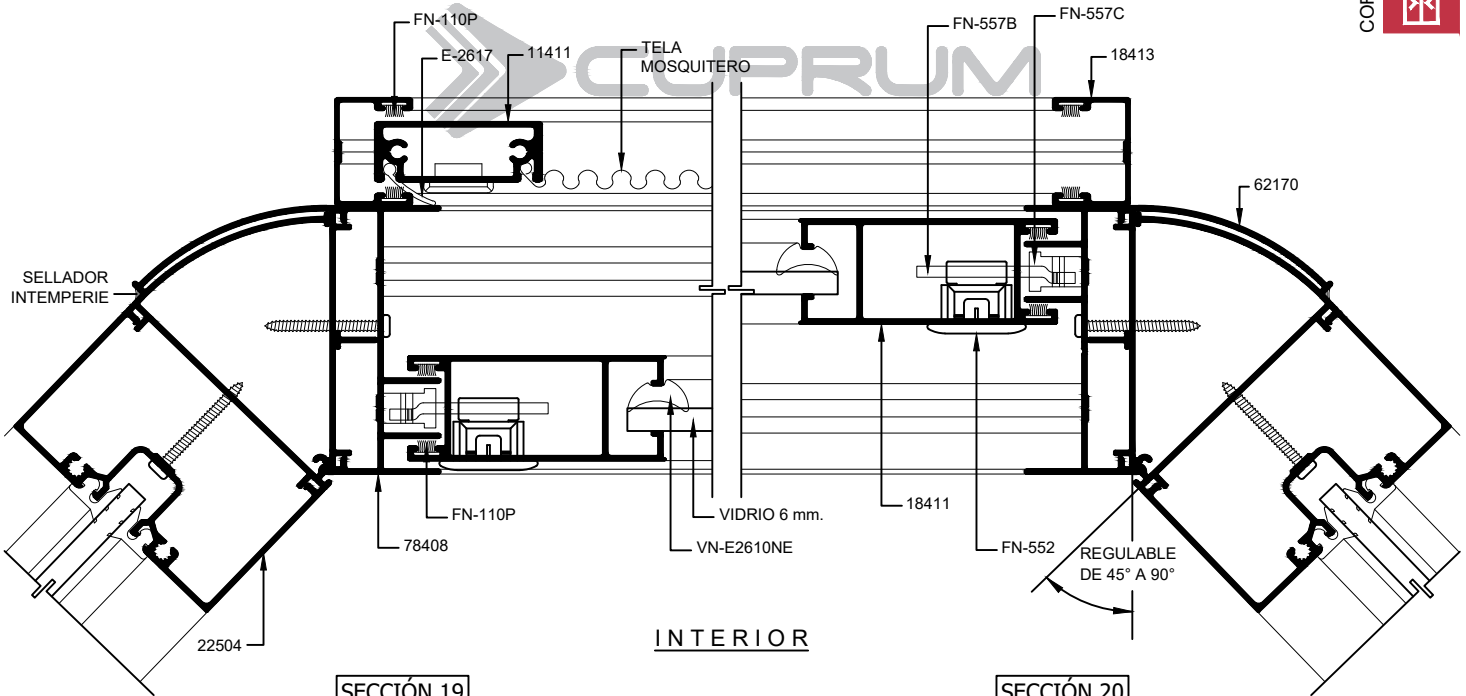

SECCIÓN 19

SECCIÓN 20

VENTANA CORREDIZA SERIE 70 - CORTES SECCIONALES EUROVENT<sup>®</sup>

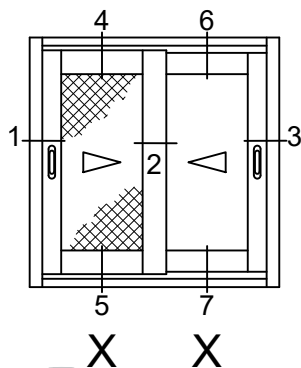

CLASSIC  
SERIE  
**S70**  
CORREDIZA

EUROVENT

SIN ESCALA

C L A S S I C

CUPRUM  
EXTERIOR

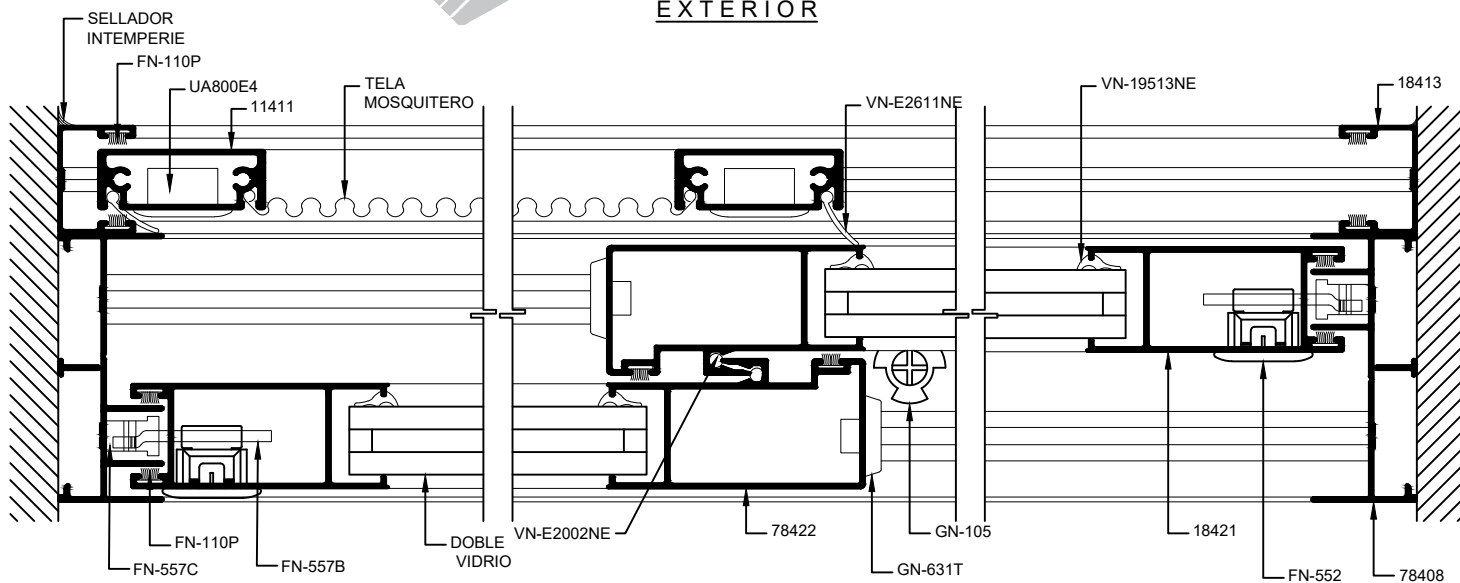

INTERIOR

SECCIÓN 1

SECCIÓN 2

SECCIÓN 3



PERFILES PARA DOBLE VIDRIO DE 18mm.

# EUROVENT VENTANA CORREDIZA SERIE 70 - CORTES SECCIONALES

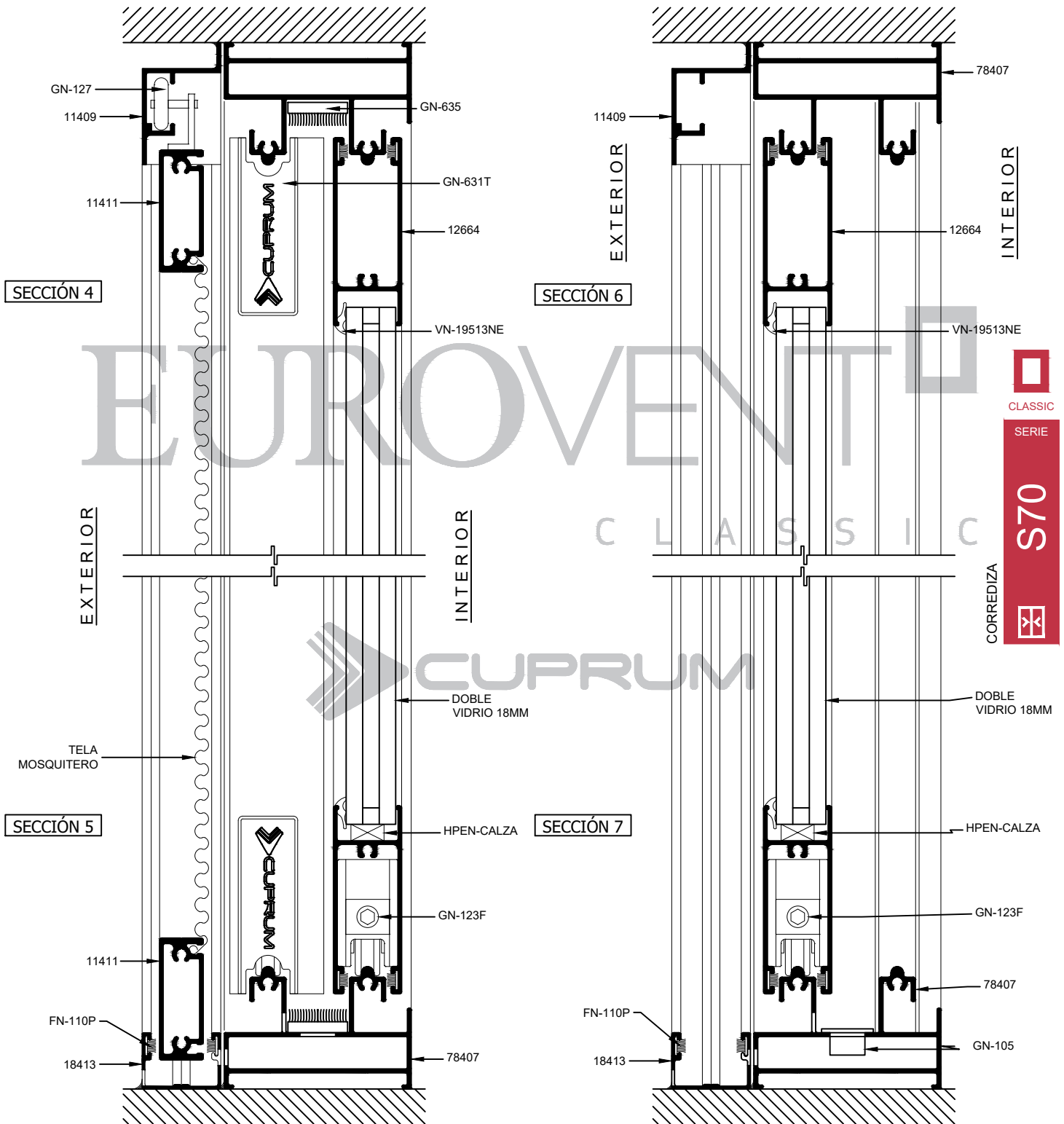

EUROVENTO CLASSIC

CLASSIC  
SERIE  
**S70**  
CORREDIZA

CUPRUM

# VENTANA CORREDIZA SERIE 70 - CORTES SECCIONALES EUROVENT<sup>®</sup>

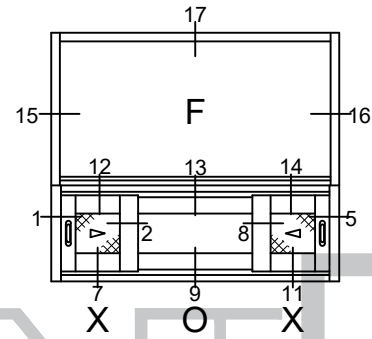
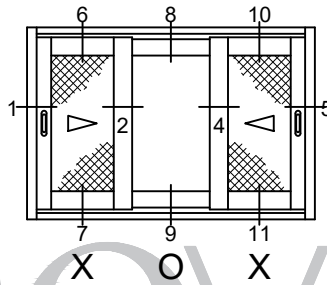
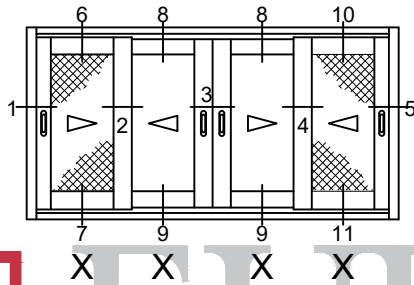

SIN ESCALA

CLASSIC  
SERIE

S70

CORREDIZA

EUROVENT  
CLASSIC

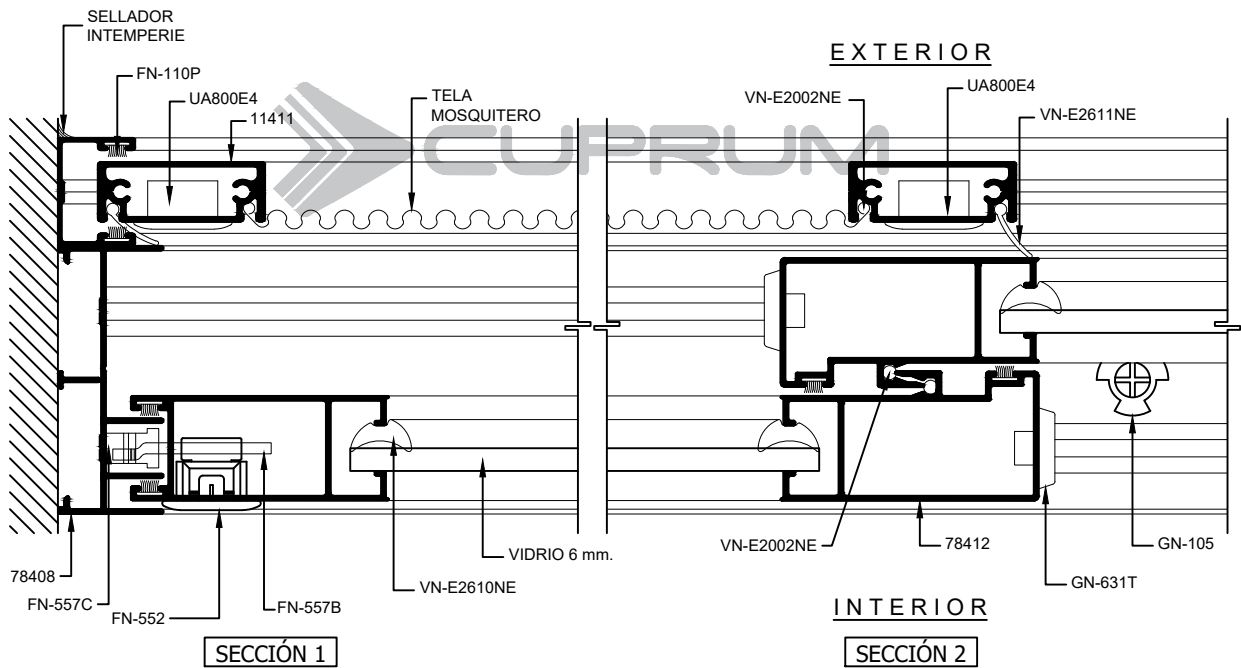

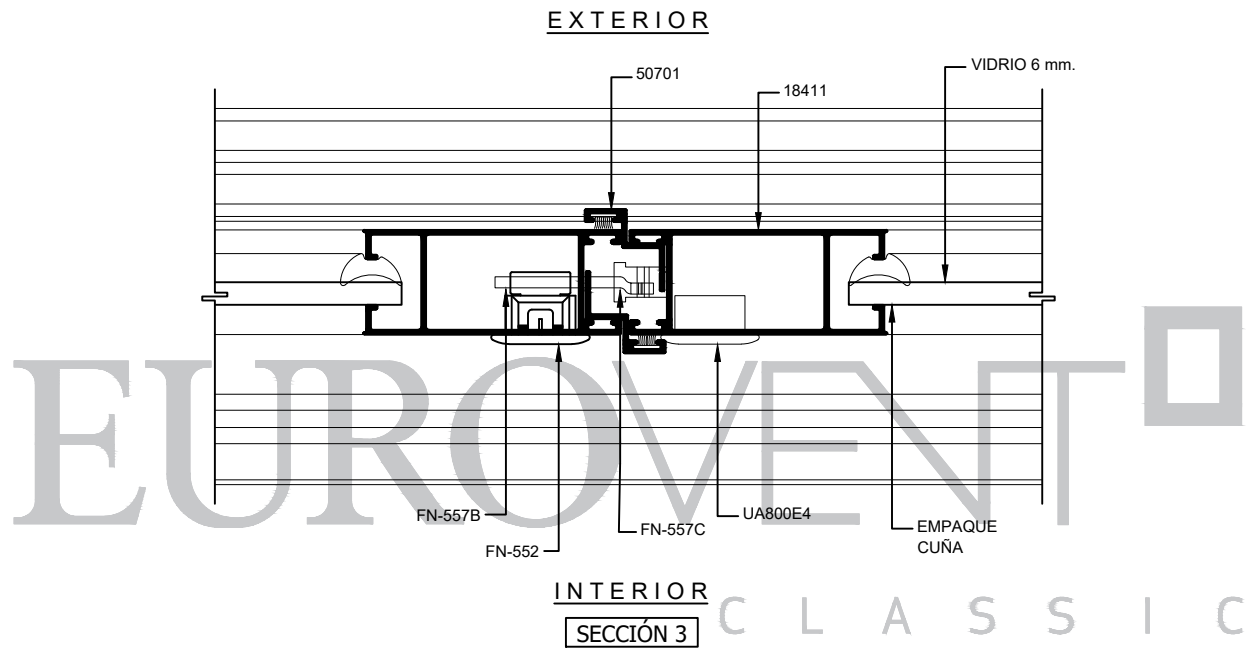

  
 CLASSIC  
 SERIE  
**S70**  
  
 CORREDIZA

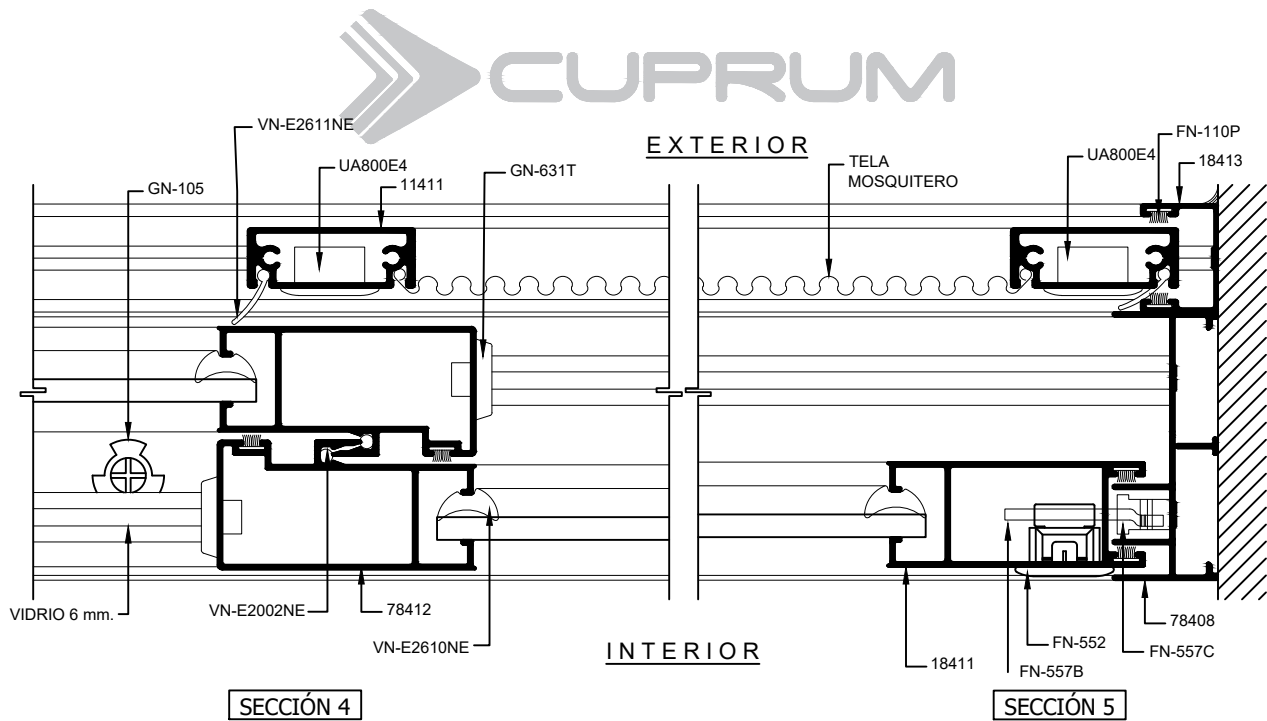



# VENTANA CORREDIZA SERIE 70 - CORTES SECCIONALES EUROVENT<sup>®</sup>

CLASSIC  
SERIE  
**S70**  
CORREDIZA

SECCIÓN 6

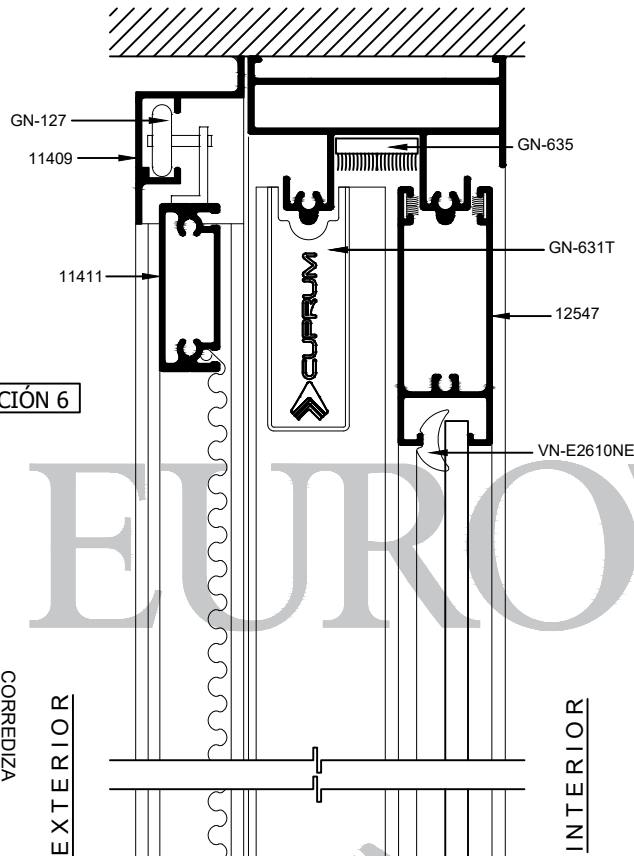

SECCIÓN 8

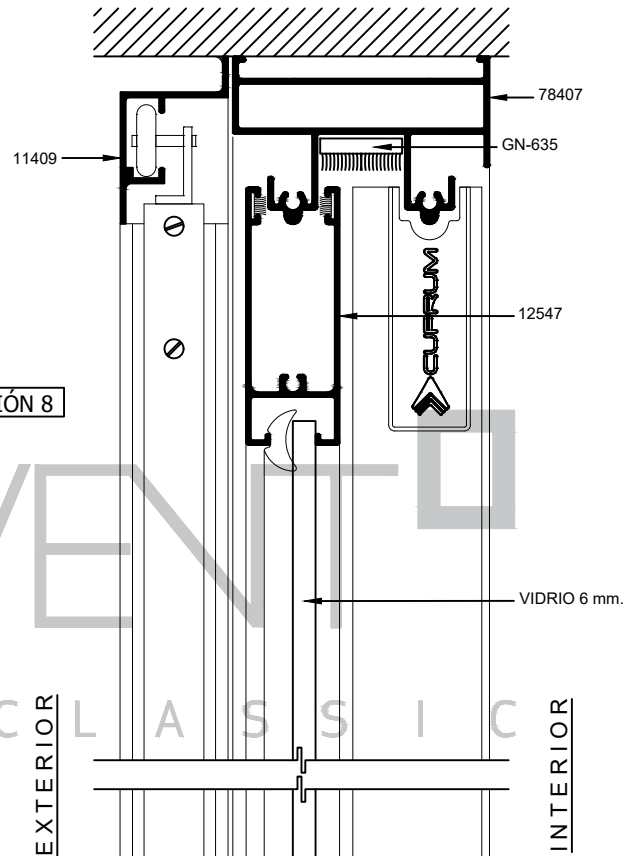

SECCIÓN 7

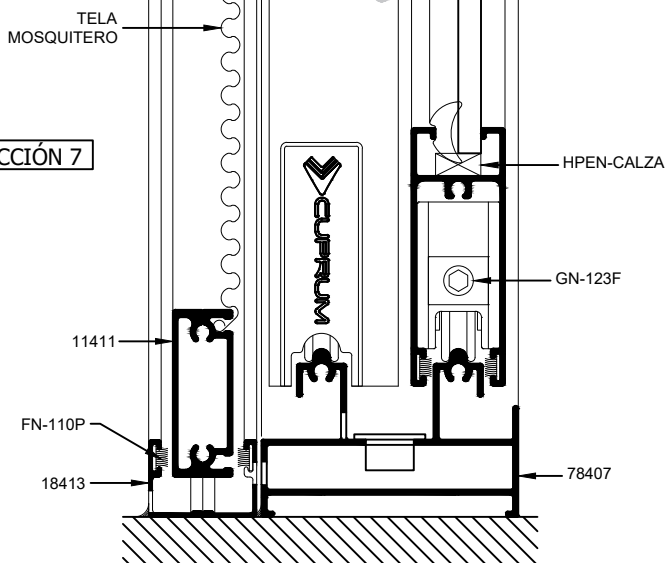

SECCIÓN 9

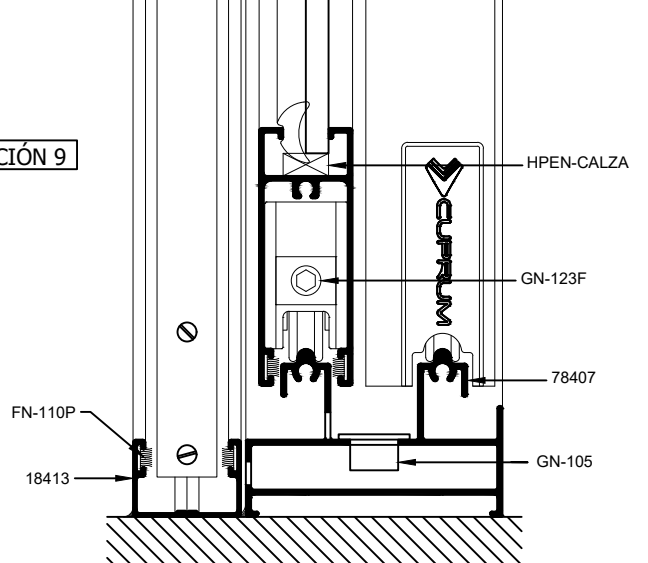

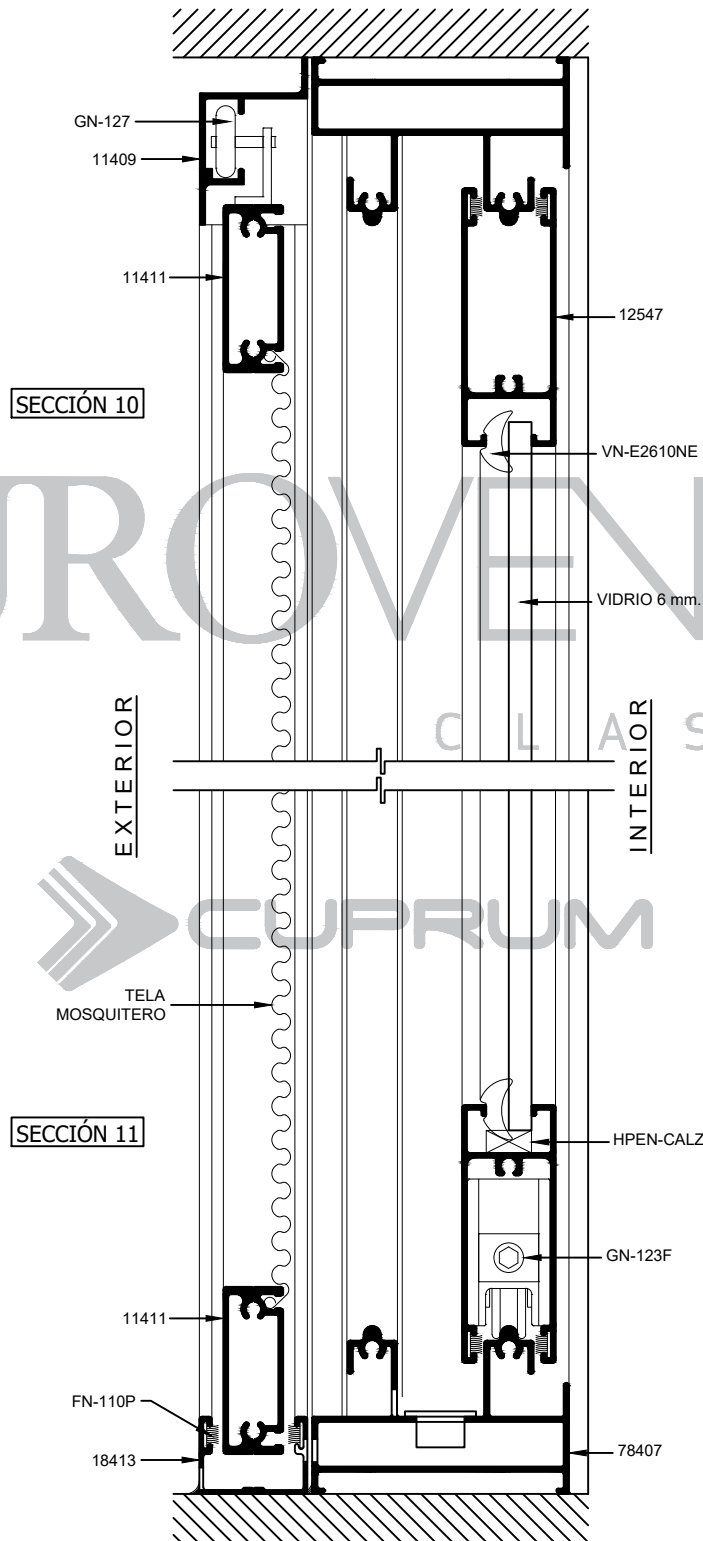

EUROVENT<sup>®</sup> CLASSIC

CUPRUM

CLASSIC  
SERIE  
**S70**  
CORREDIZA

# VENTANA CORREDIZA SERIE 70 - CORTES SECCIONALES EUROVENT<sup>®</sup>

CLASSIC  
SERIE  
**S70**  
CORREDIZA

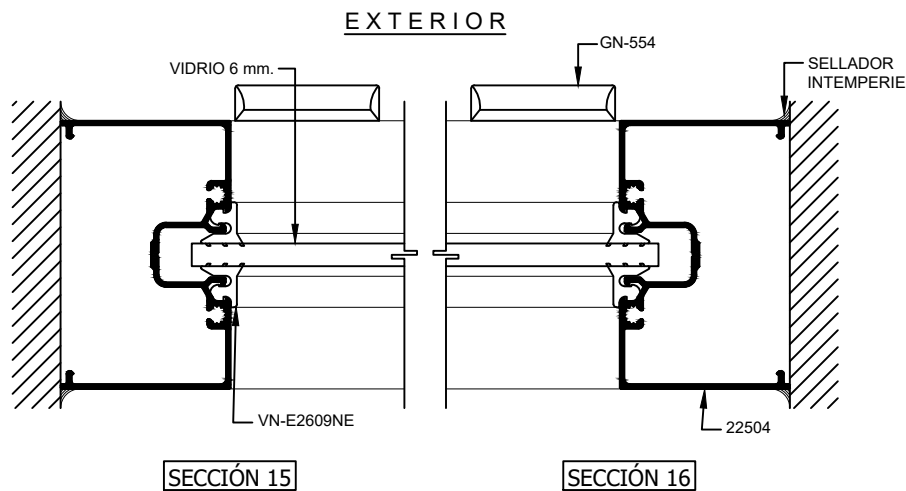
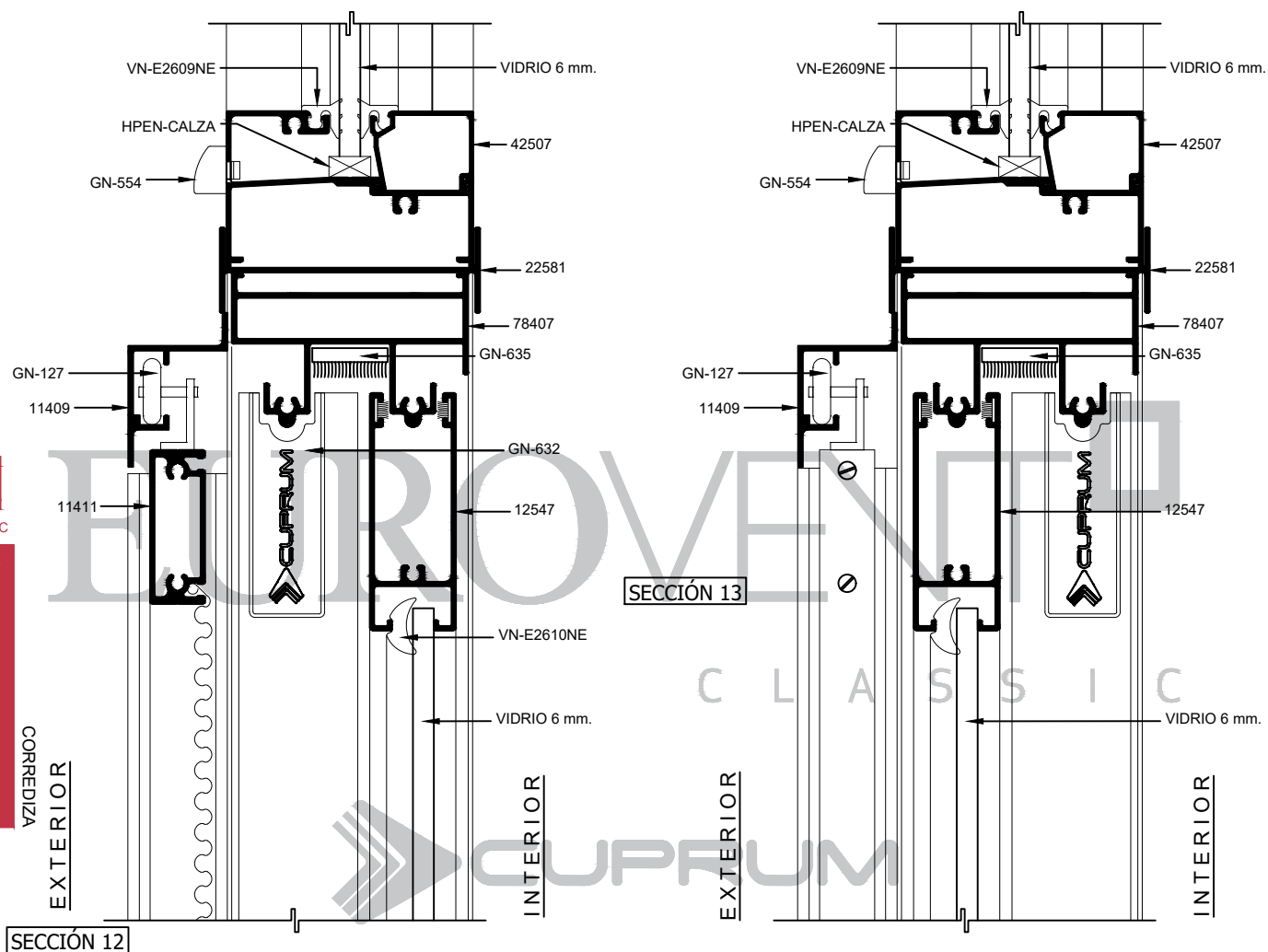

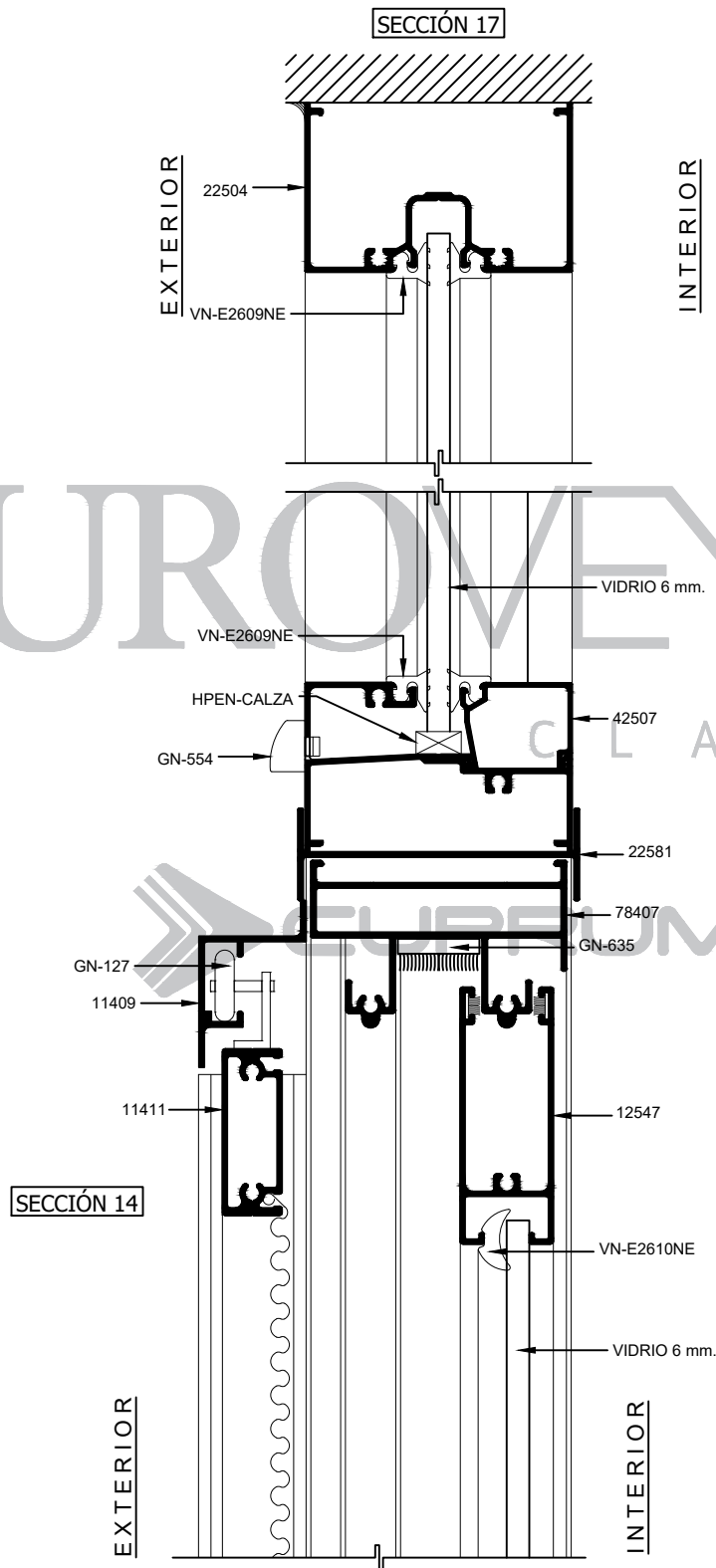

EUROVENT CLASSIC



CLASSIC

SERIE

S70



CORREDIZA

CLASSIC  
SERIE  
**S70**  
CORREDIZA

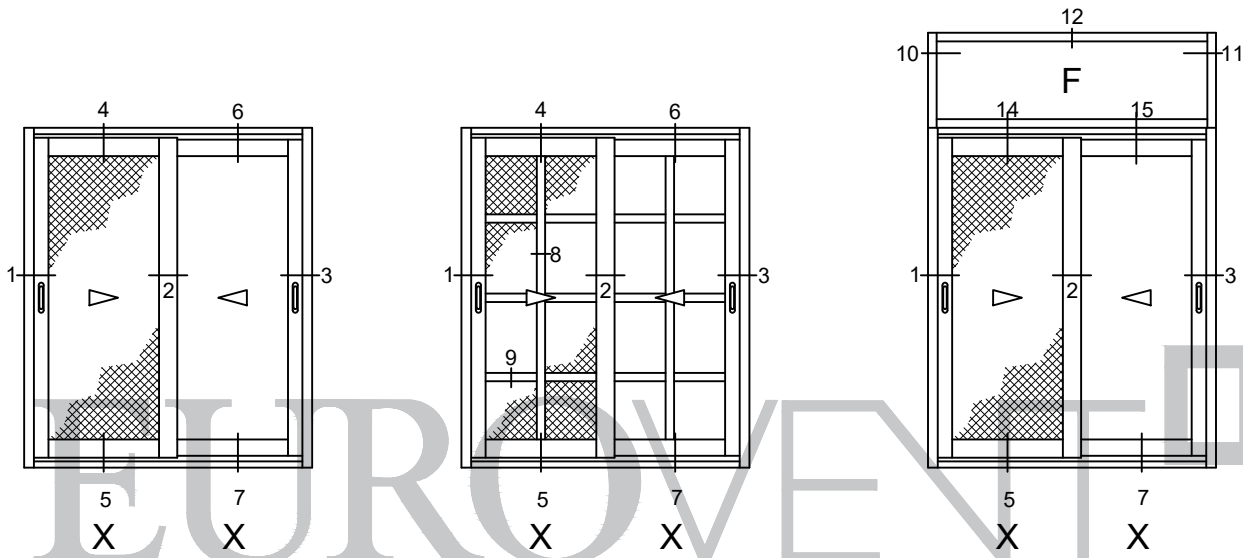

C L A S S I C SIN ESCALA



EXTERIOR

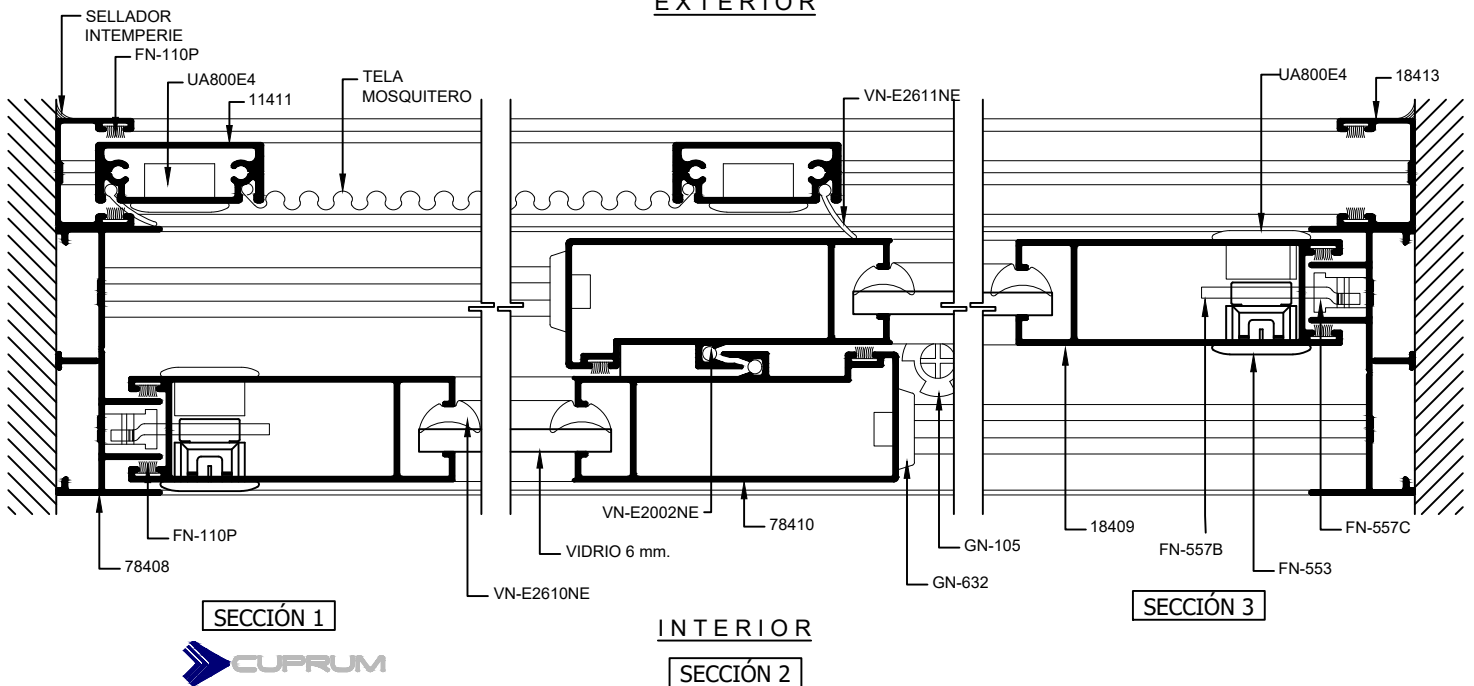

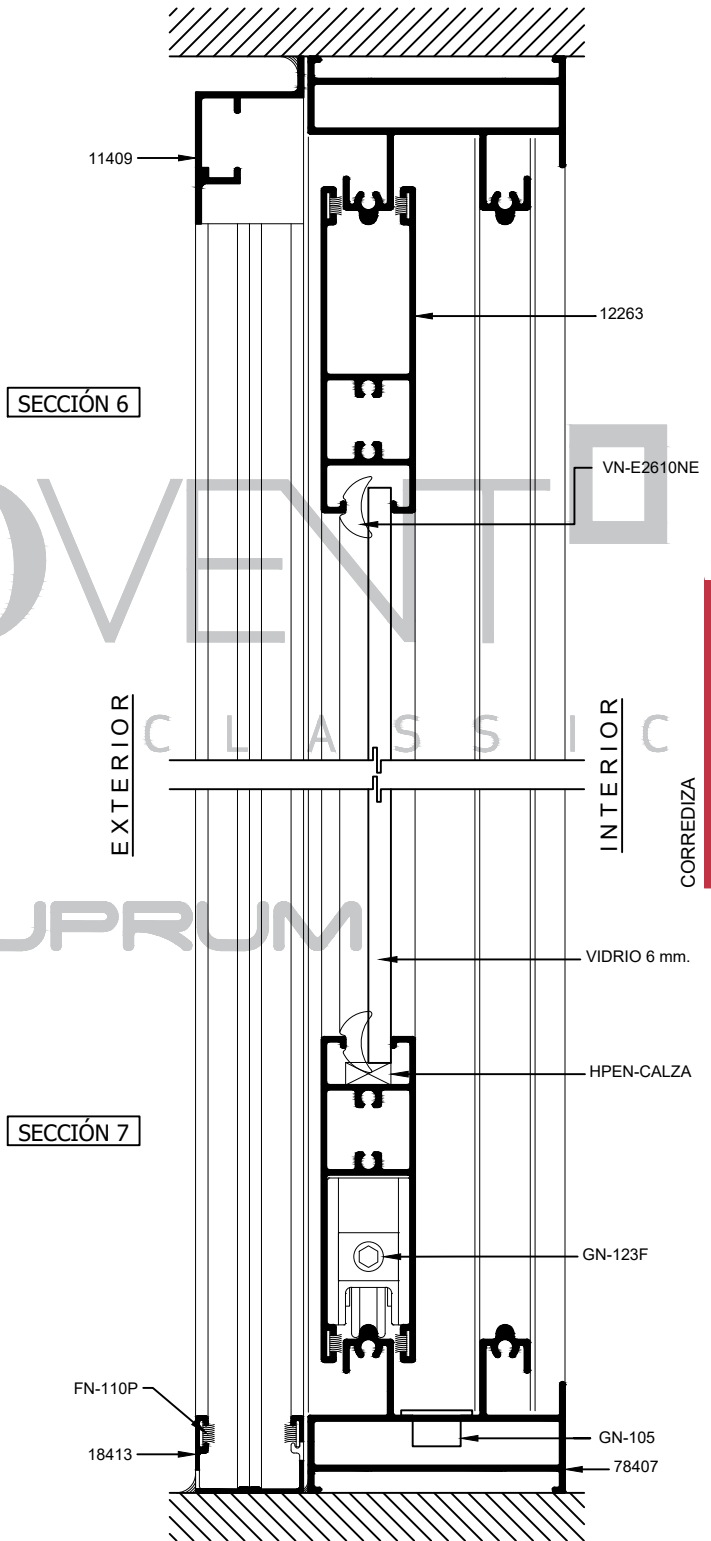
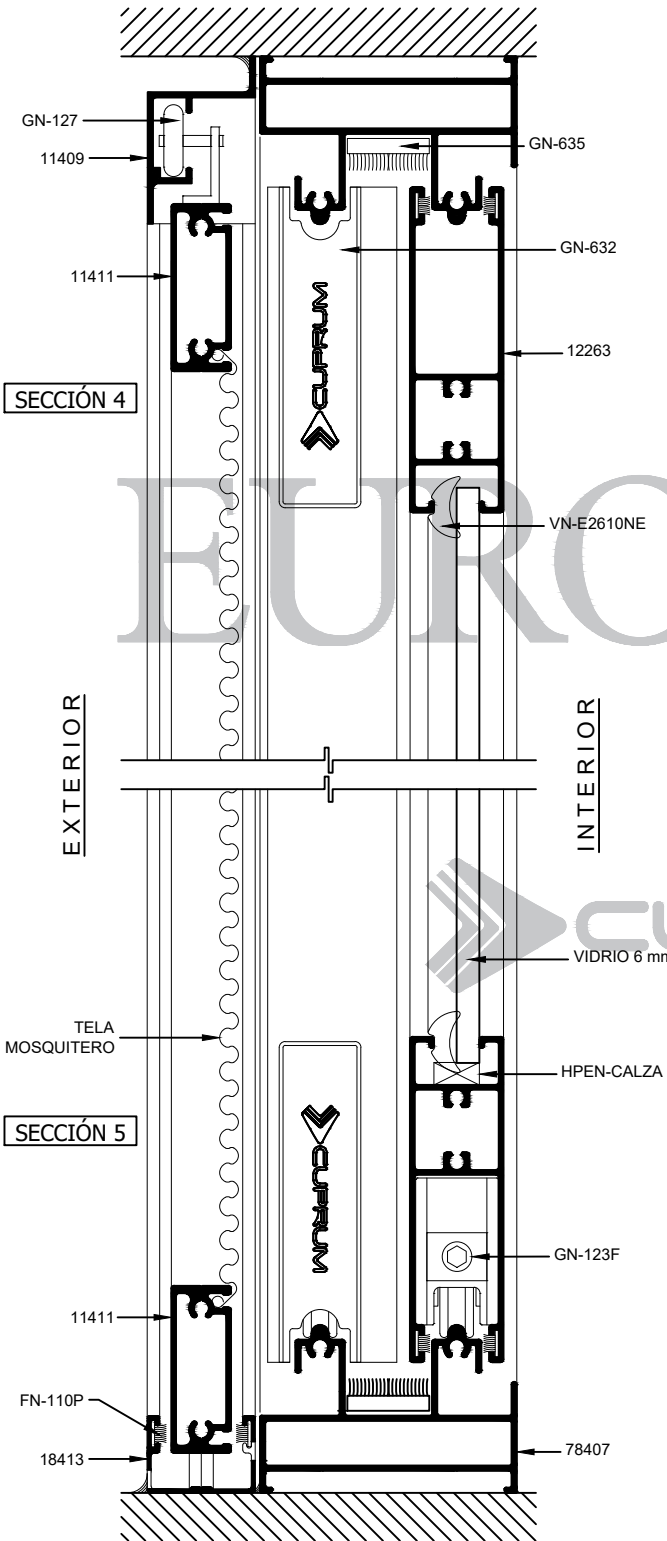

CLASSIC  
SERIE

**S70**

CORREDIZA

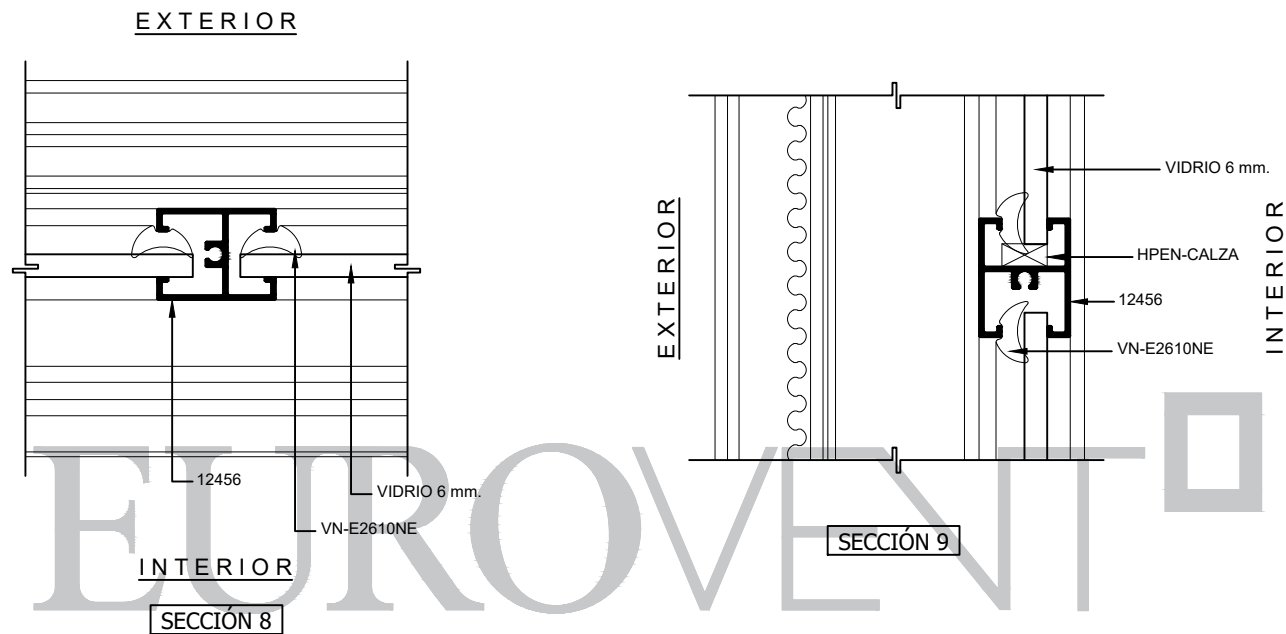

CLASSIC  
SERIE  
**S70**  
CORREDIZA

EUROVENT  
CLASSIC

CUPRUM

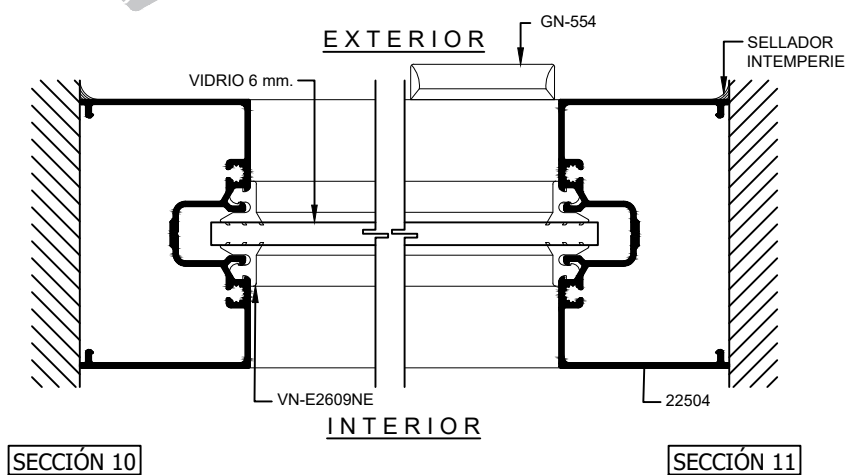

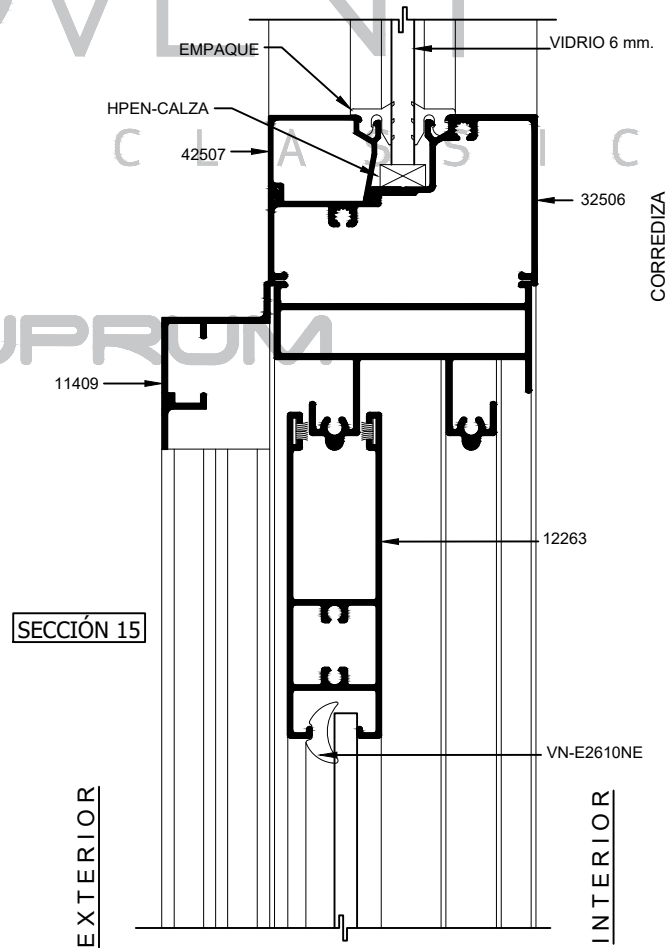
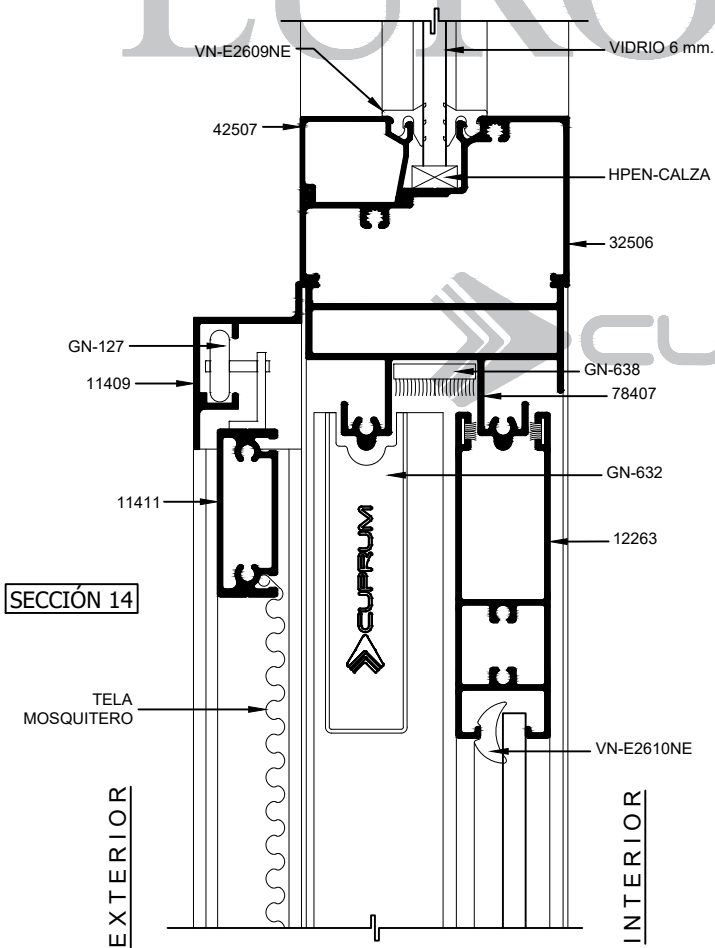
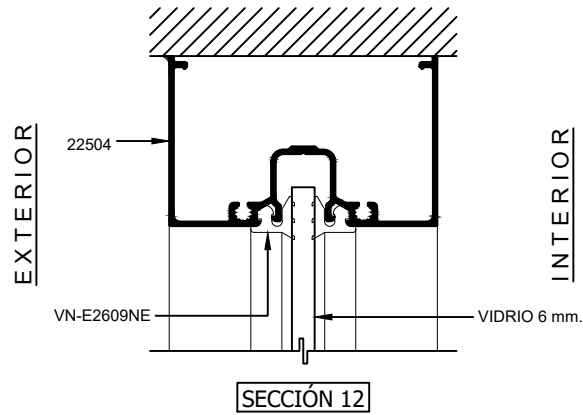

EUROVENT



CLASSIC

SERIE

S70



CORREDIZA



CLASSIC  
SERIE  
**S70**  
CORREDIZA

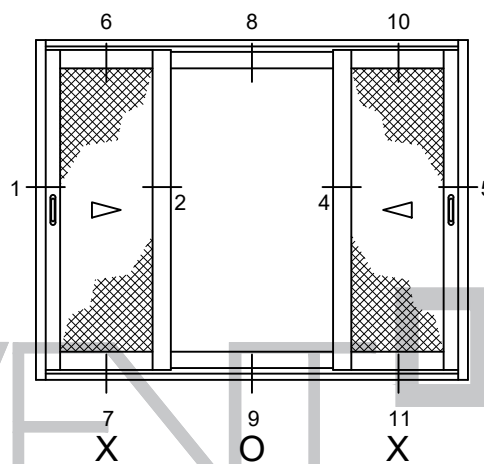
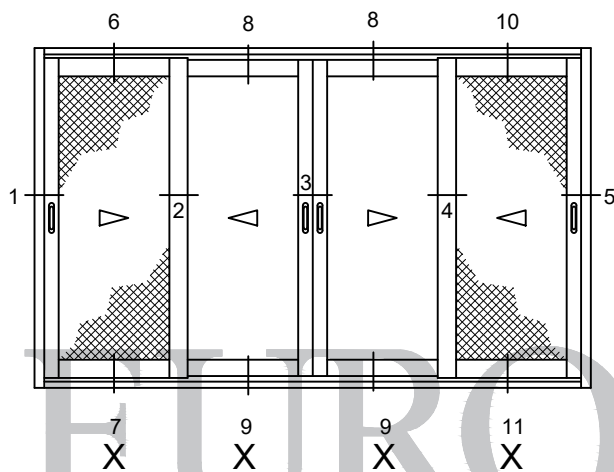

C L A S S I C

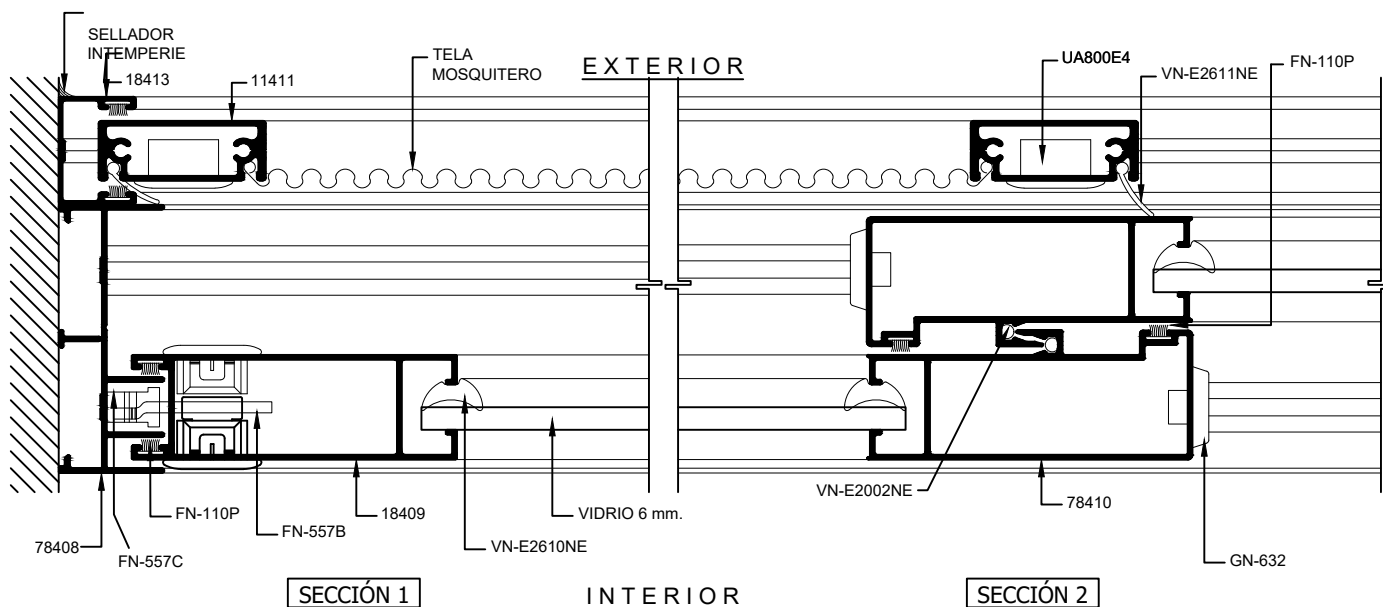

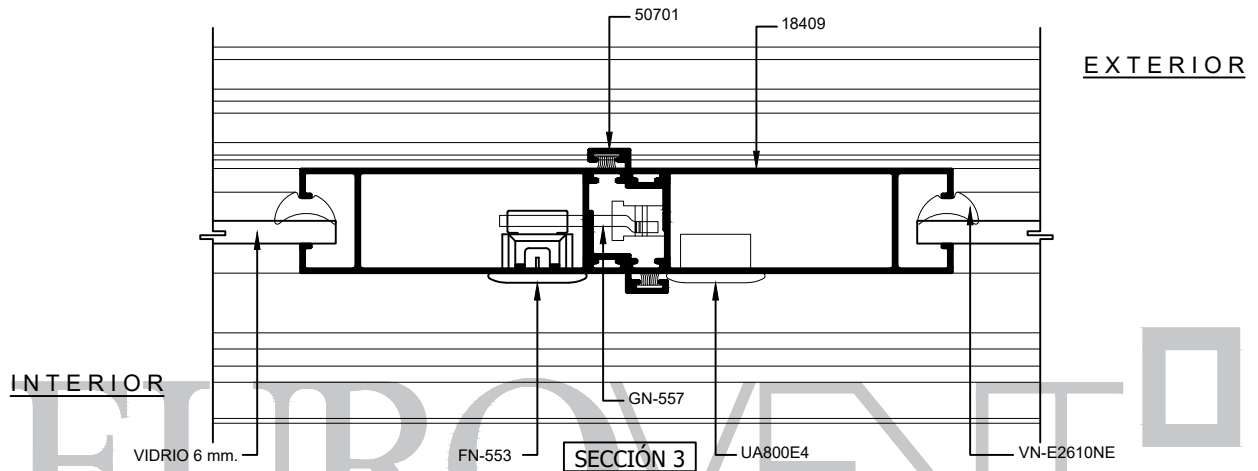

CLASSIC  
SERIE  
**S70**  
CORREDIZA

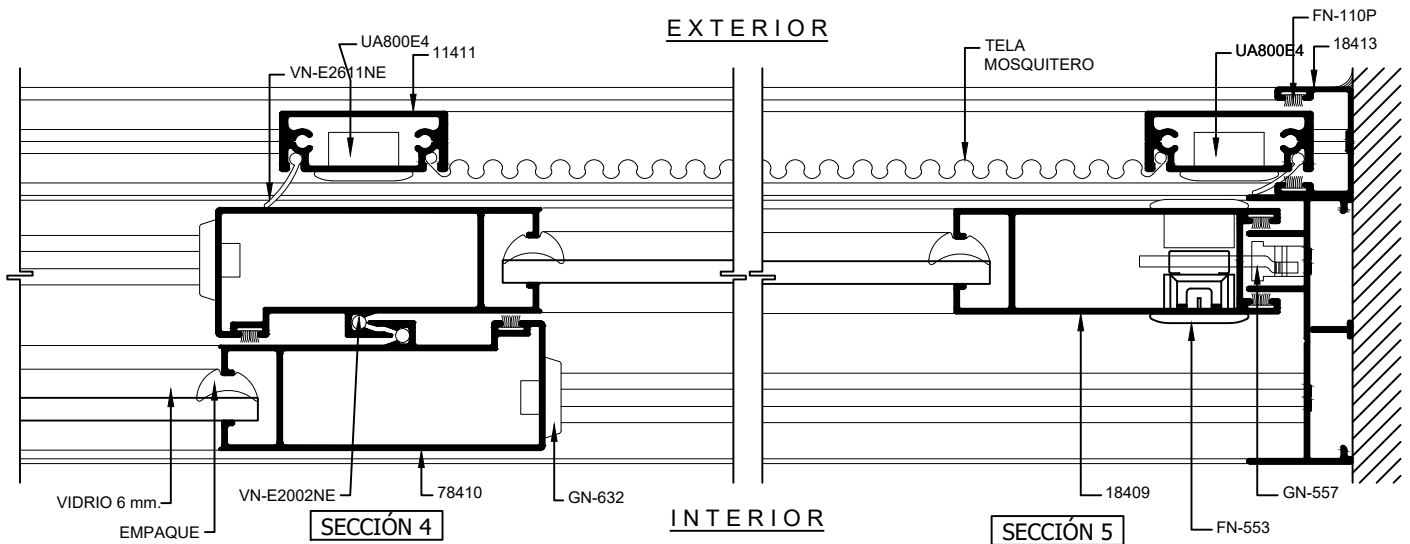

CLASSIC  
SERIE  
**S70**  
CORREDIZA

EUROVENT  
CLASSIC

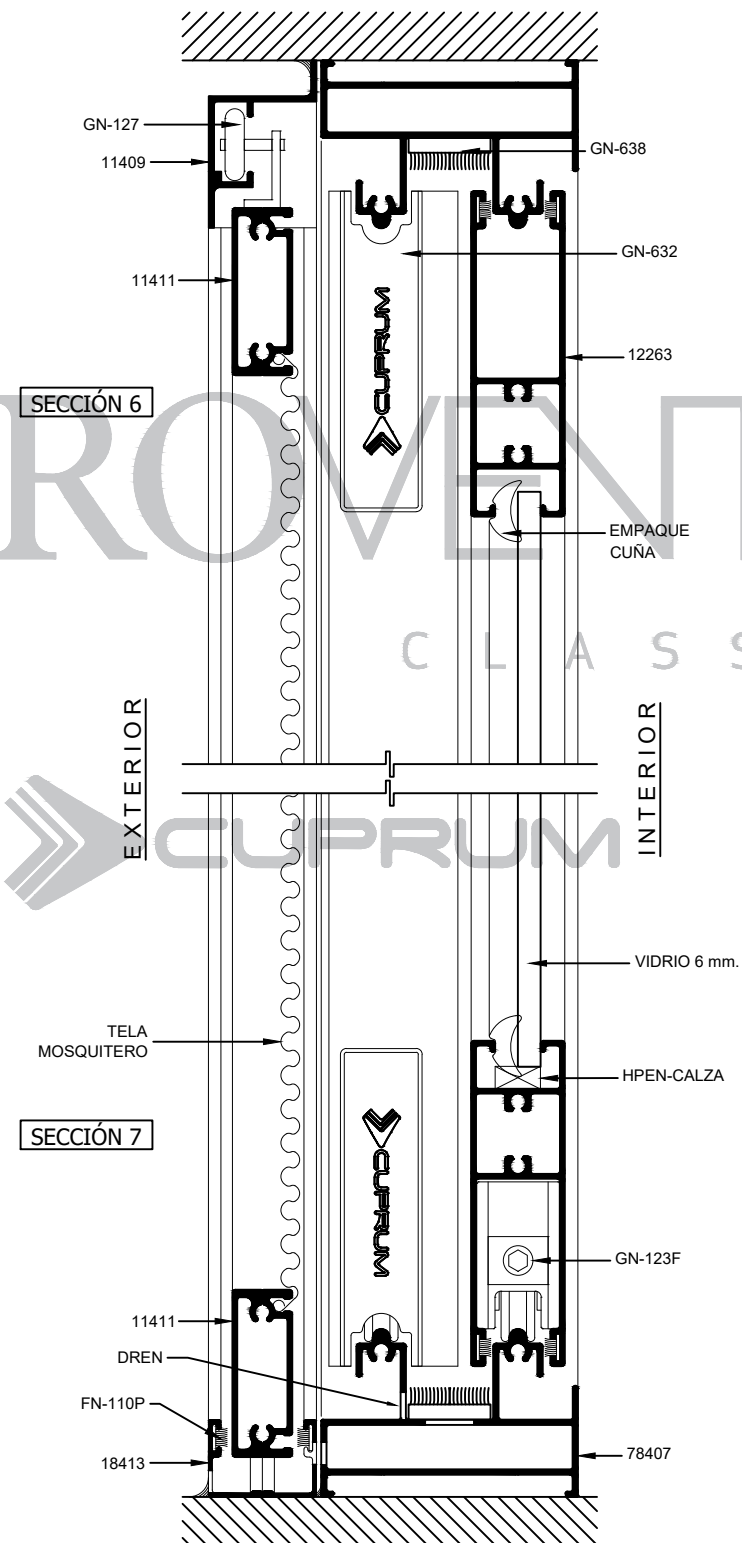

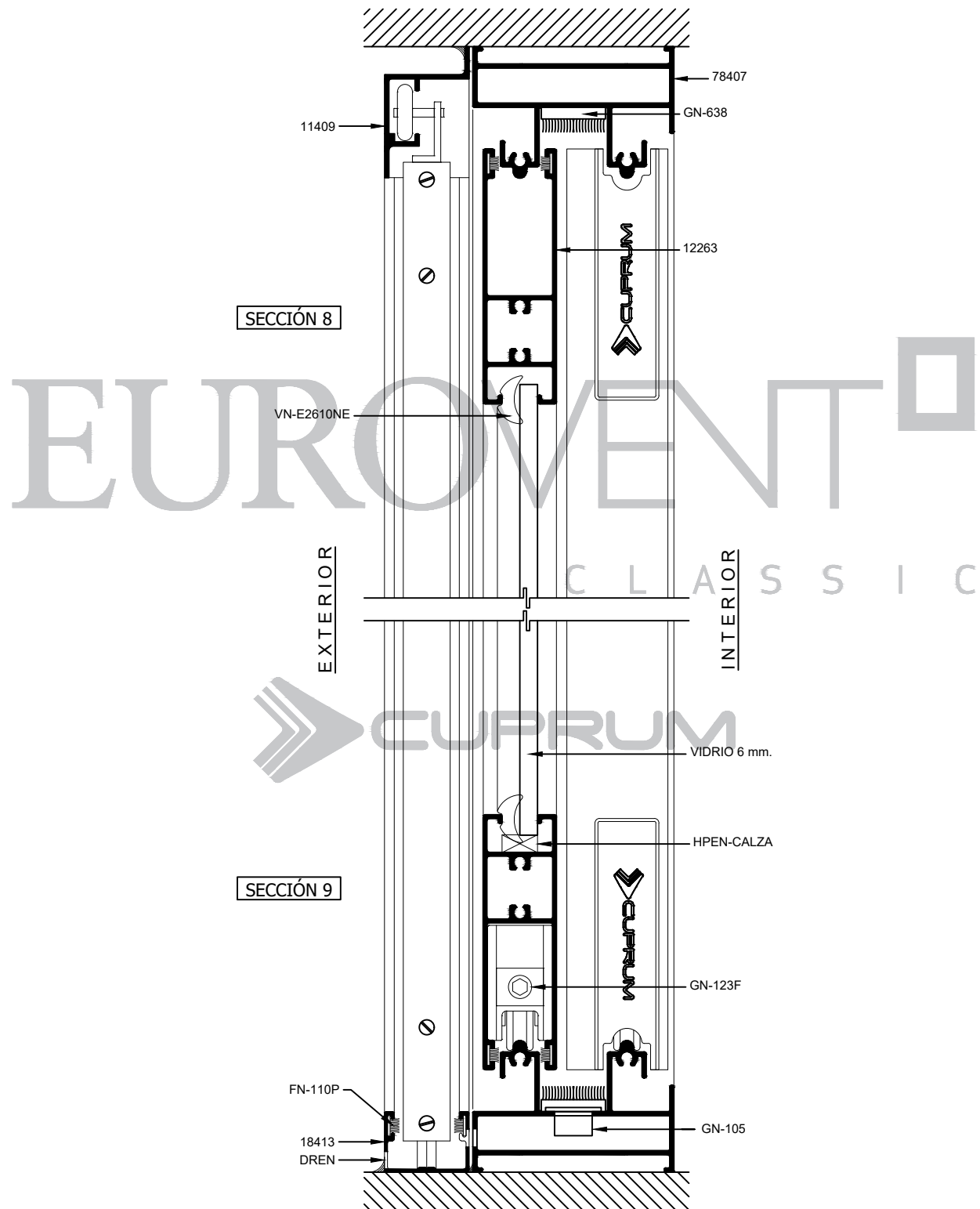

CLASSIC  
SERIE  
**S70**  
CORREDIZA

CLASSIC  
SERIE  
**S70**  
CORREDIZA

EUROVENT

CLASSIC

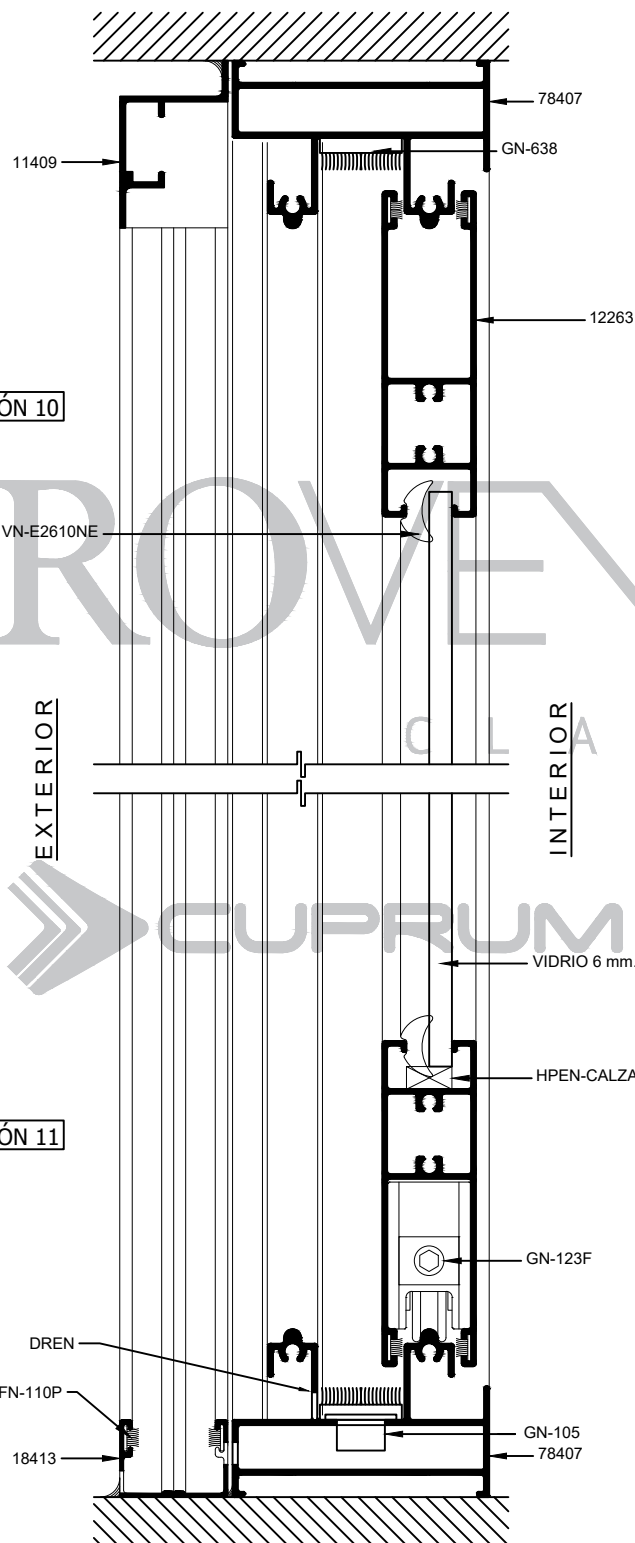

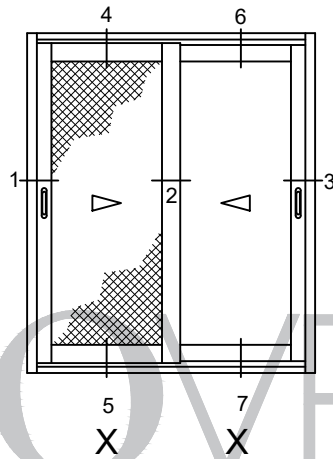

EUROVENT<sup>®</sup>

CLASSIC

SIN ESCALA



CLASSIC

SERIE

S70

CORREDIZA

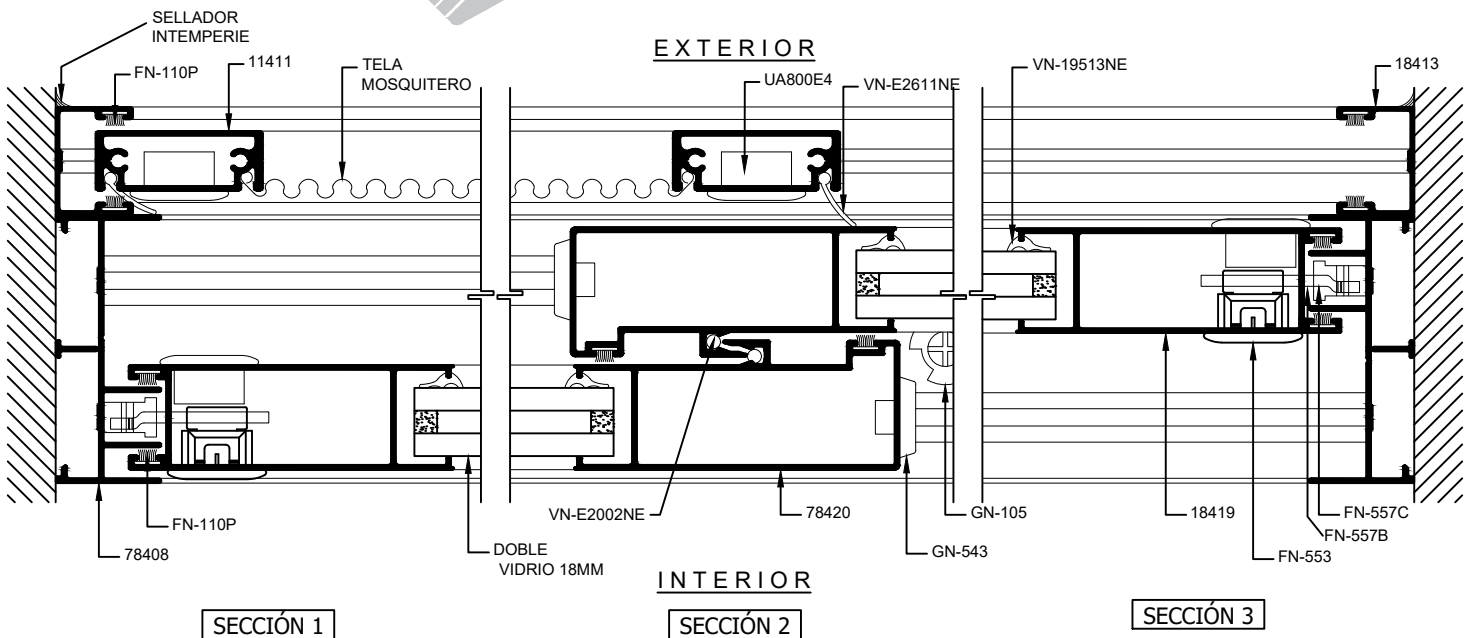

CLASSIC  
SERIE  
**S70**  
CORREDIZA

SECCIÓN 4

SECCIÓN 6

SECCIÓN 5

SECCIÓN 7

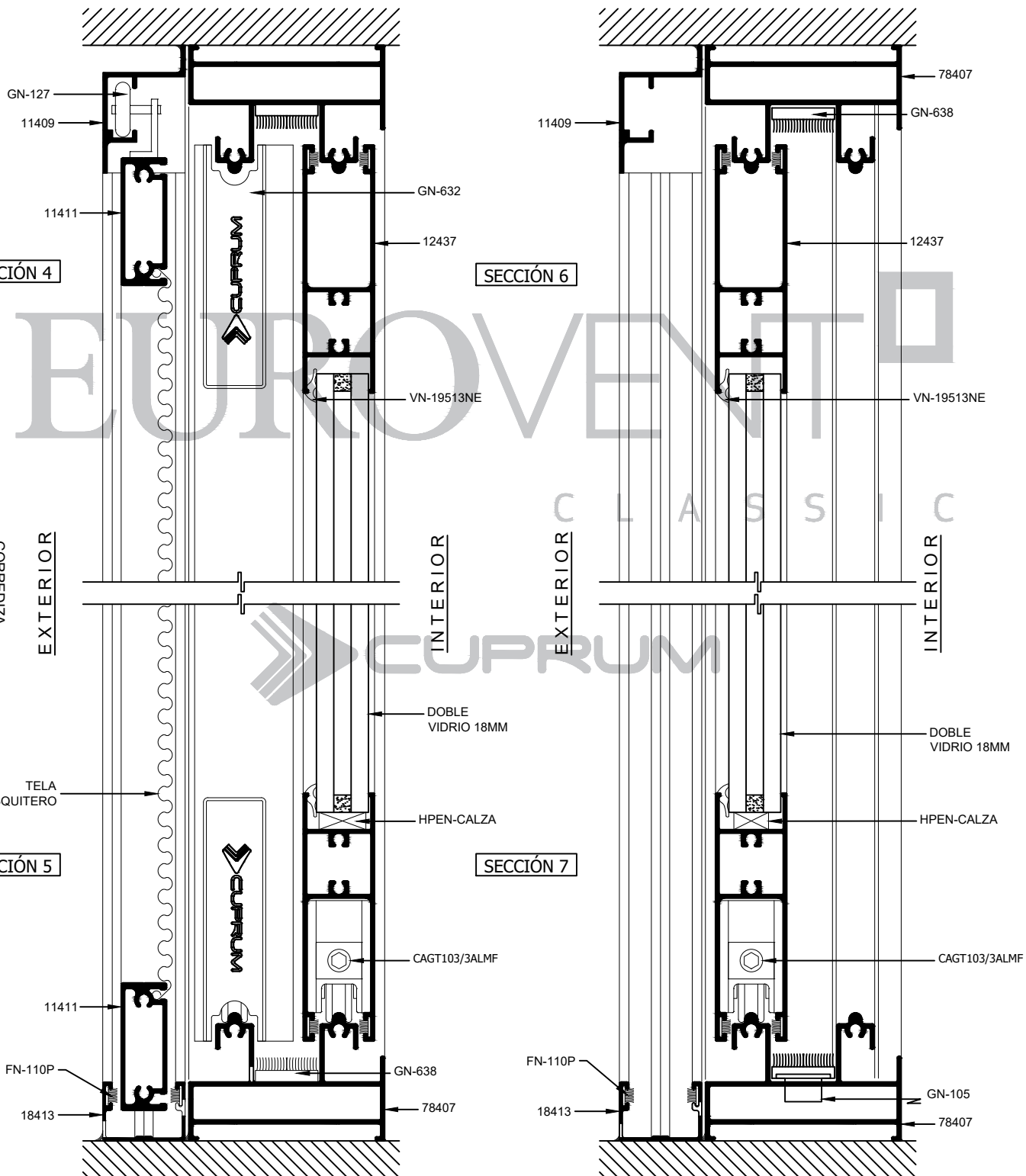

**GN-506A**  
TROQUEL VENTANA Y PUERTA SERIE 70

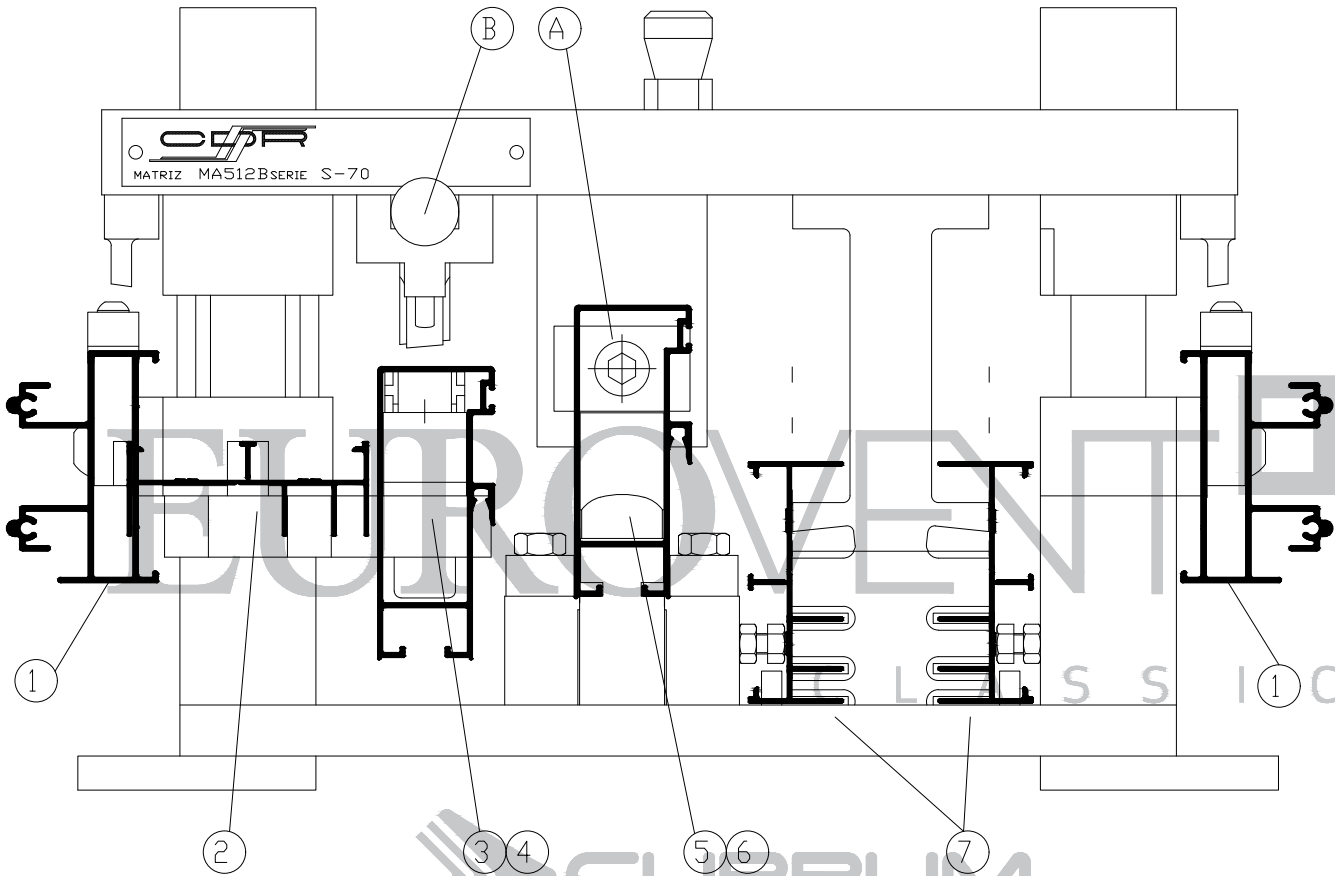

  
 CLASSIC  
 SERIE  
**S70**  
  
 CORRERIZA

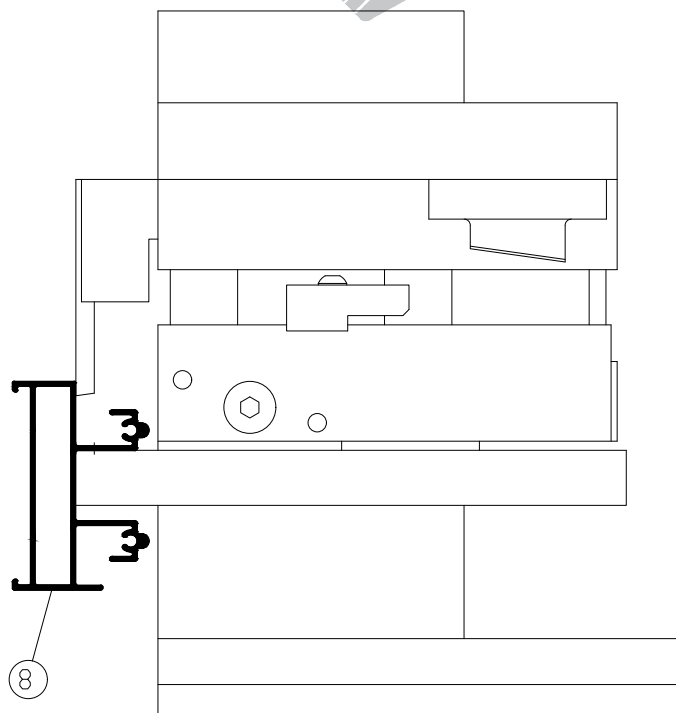

INDICACIONES

PARA REALIZAR TODAS LAS OPERACIONES DE TROQUELADO, EL MATERIAL DEBE DE ESTAR CORTADO A MEDIDA DE FABRICACIÓN.



OPERACIÓN 1

**78407** RIEL-CABEZAL  
DREN TUBULAR

OPERACIÓN 2

**78408** JAMBA  
BARRENOS PARA ENSAMBLE  
REALIZAR PRIMERO OPERACIÓN 7

CLASSIC  
SERIE  
**S70**  
CORREDIZA

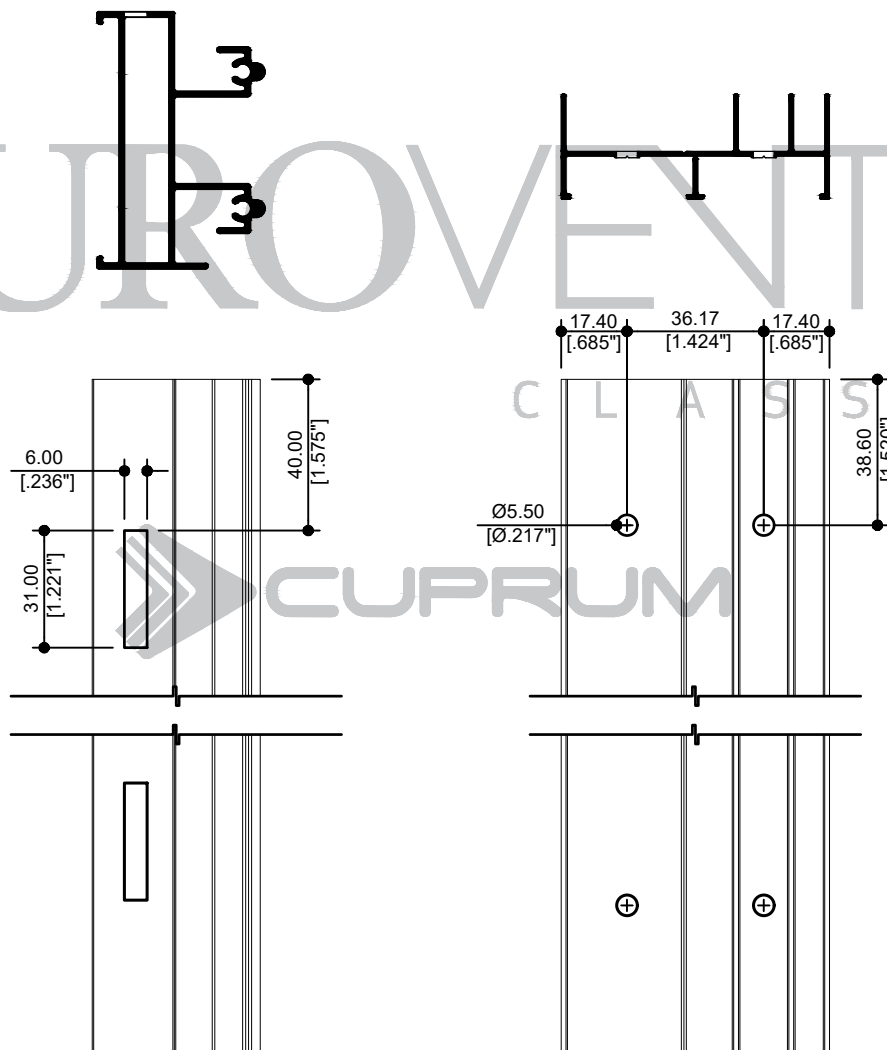

**78412** TRASLAPE  
SAQUE PARA PISTA Y BARRENO  
REALIZAR ANTES OPERACIÓN 5  
PERILLA "B" AFUERA

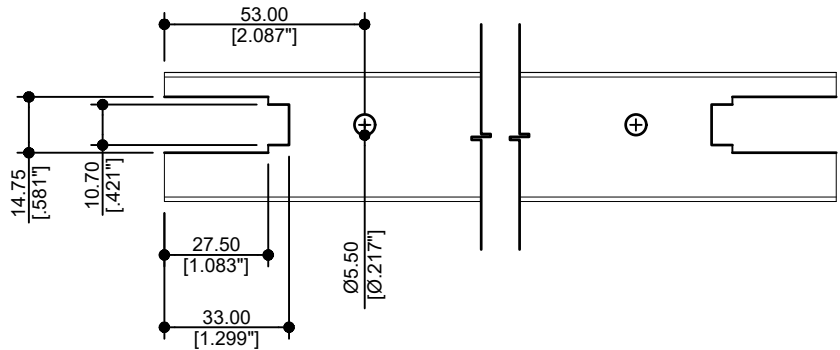
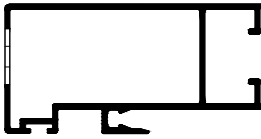

OPERACIÓN 3

**18411** CERCO  
SAQUE PARA PISTA Y BARRENO  
REALIZAR ANTES OPERACIÓN 5  
PERILLA "B" AFUERA

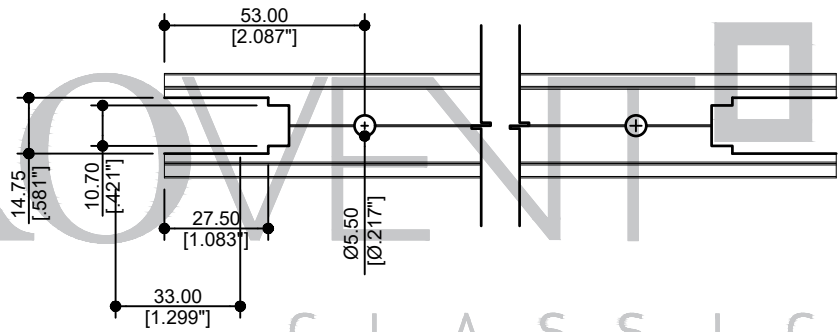

**78412** TRASLAPE  
SAQUE PARA PISTA Y BARRENO  
REALIZAR ANTES OPERACIÓN 6  
PERILLA DENTRO

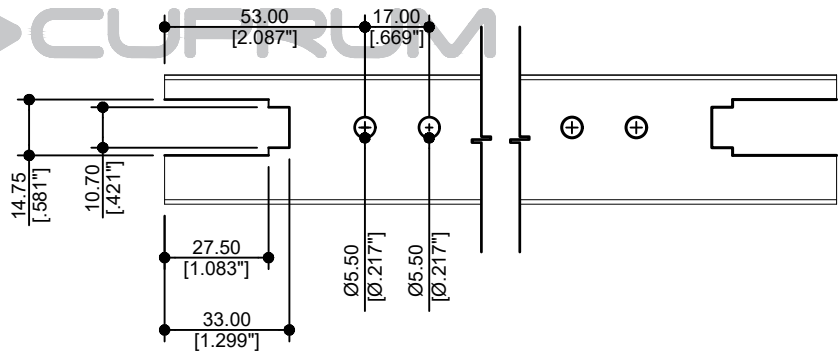
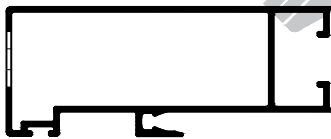

OPERACIÓN 4

**18411** CERCO  
SAQUE PARA PISTA Y BARRENO  
REALIZAR ANTES OPERACIÓN 6  
PERILLA "B" DENTRO

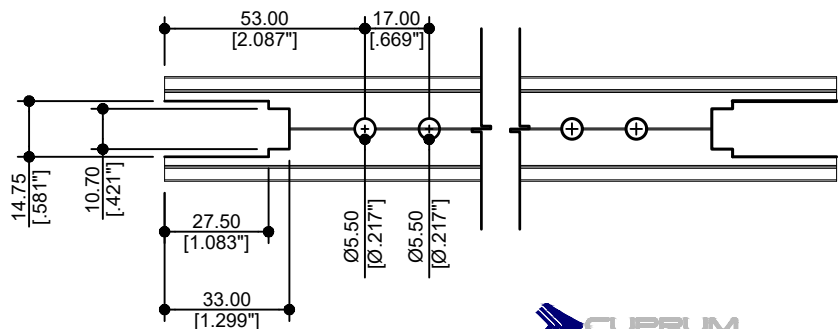

CLASSIC  
SERIE

S70

CORREDIZA



**78412**  
TRASLAPE ENCASTRADO  
CON TOPE "A"

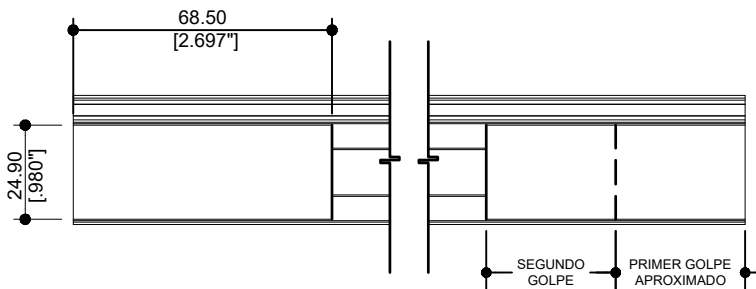
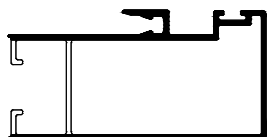

OPERACIÓN 5

**18411**  
CERCO ENCASTRADO  
CON TOPE "A"

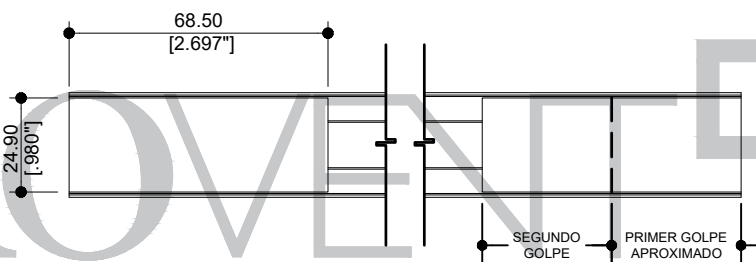

CLASSIC  
SERIE

S70



CORREDIZA

PARA EVITAR UNA POSIBLE RUPTURA DEL  
CORTADOR, AL REALIZAR LA OPERACIÓN, SE  
RECOMIENDA HACERLO EN DOS PASOS.

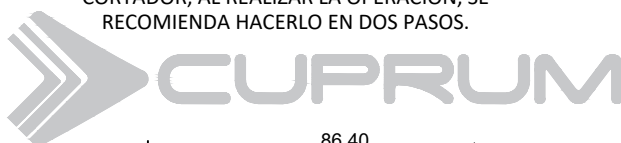

**78410**  
TRASLAPE ENCASTRADO  
SIN TOPE "A"

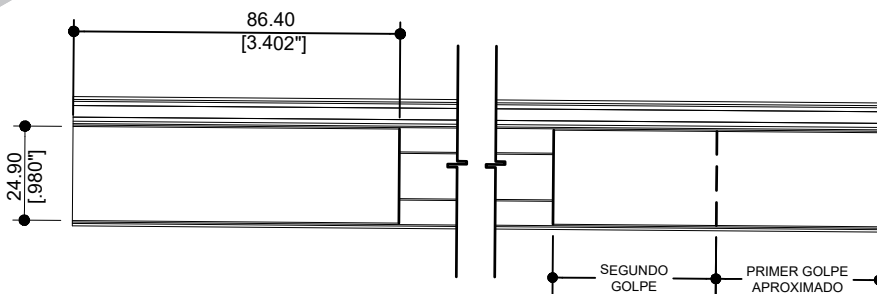
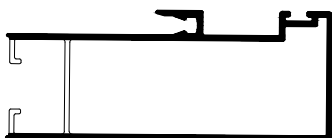

OPERACIÓN 6

**18409**  
CERCO ENCASTRADO  
SIN TOPE "A"

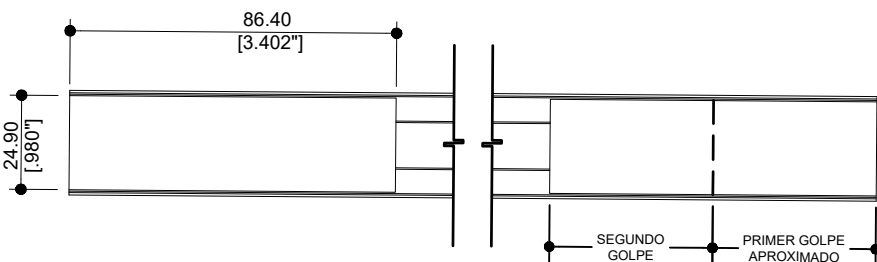

OPERACIÓN 7

**78408** JAMBA  
SAQUE PARA ENSAMBLE

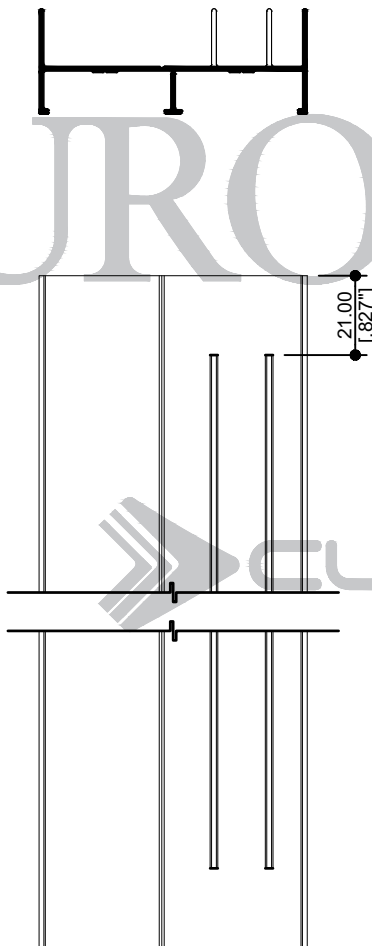

OPERACIÓN 8

**78407** ZOCLO-CABEZAL  
DRENES DE PISTA

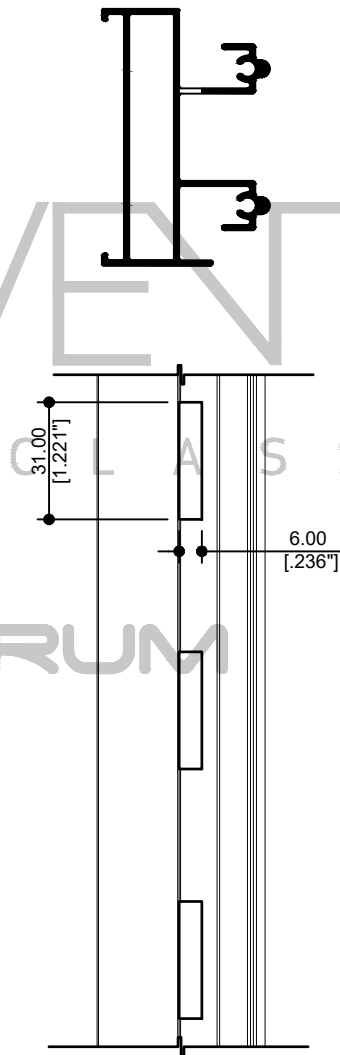

EUROVENT

CLASSIC

CUPRUM



CLASSIC

SERIE

S70

CORREDIZA



SE RECOMIENDA HACER 4 DRENES DE PISTA EQUIDISTANTES POR METRO LINEAL.

NO HACER DRENES EN LA PISTA DE BAJO DE LA HOJA CORREDIZA EN POSICIÓN CERRADA.

NO HACER DRENES EN LA PISTA INTERIOR.

**18411** CERCO  
CIERRE EMBUTIDO

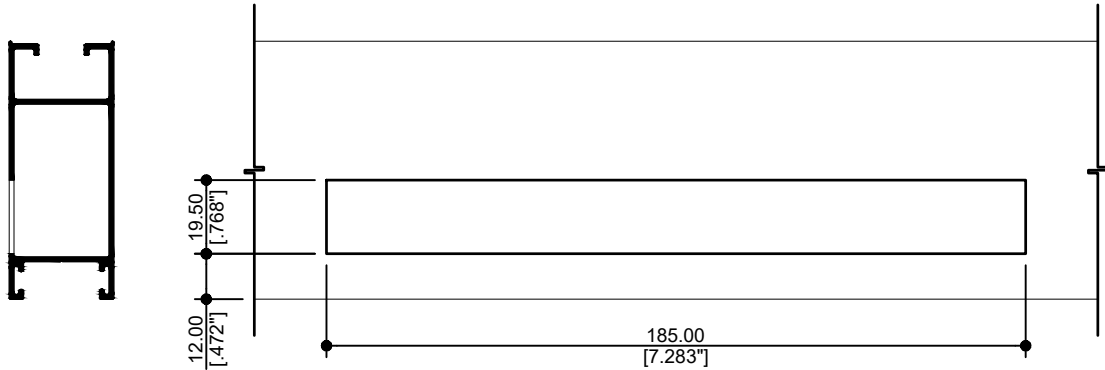

MEDIDA DEL CIERRE

CONTRA Y GANCHO

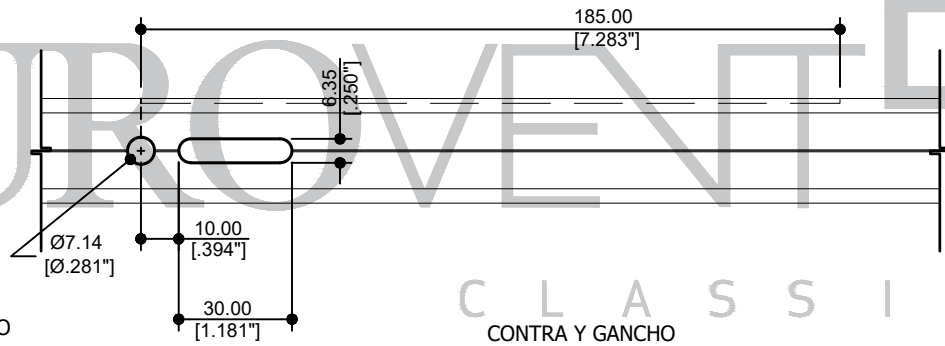

CONTRA Y GANCHO

**18411** CERCO  
CIERRE EMBUTIDO



SERIE

S70

CORREDIZA

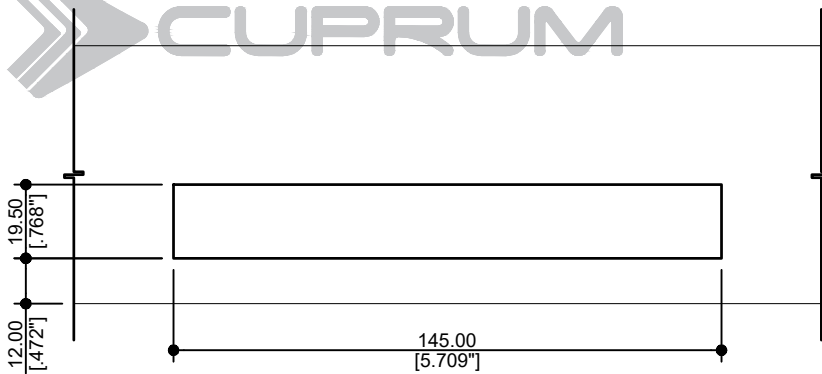
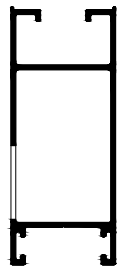

MEDIDA DEL CIERRE

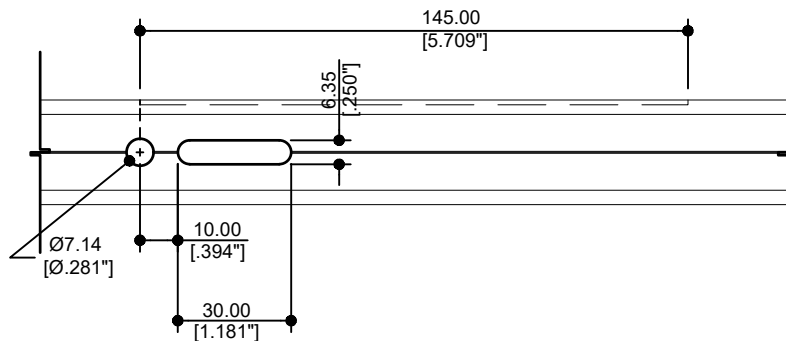

OPERACIÓN MANUAL

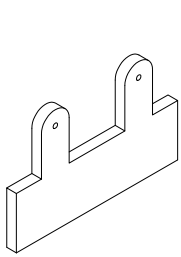

**EH-70I**  
JUNTA DE HERMETICIDAD

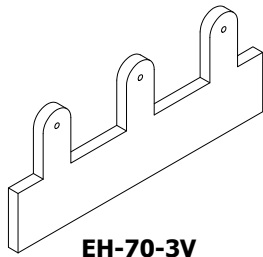

**EH-70-3V**  
JUNTA DE HERMETICIDAD  
RIEL 3 VIAS

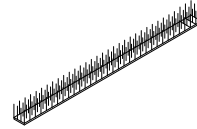

**FN-110P**  
FELPA CON PÁSTICO

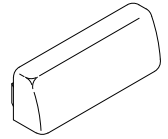

**GN-554**  
TAPA DREN



**GN-105**  
TAPÓN DESAGÜE



**HPEN-CALZA**  
CALZA DE 1/4" x 3/8" x 4"

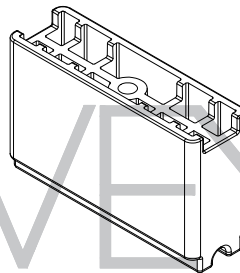

**PN-0301**  
CALZO HOJA FIJA

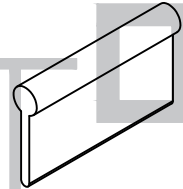

**VN-E2611NE**  
VINIL ALETA



CLASSIC

SERIE

S70



CORREDIZA

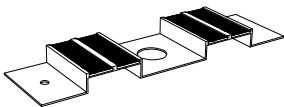

**GN-635**  
CORTAVIENTO  
VENTANA

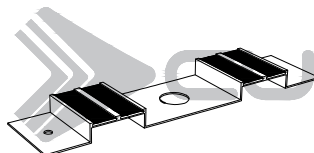

**GN-638**  
CORTAVIENTO  
PUERTA



**VN-E2002NE**  
EMPAQUE COLA DE RATA

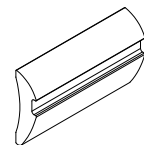

**VN-E2610NE**  
VN-E2610NE

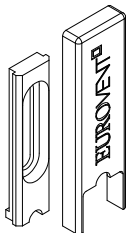

**GN-631T**  
TAPA TRASLAPE VENTANA

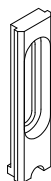

**GN-633T**  
TAPA CERCO VENTANA

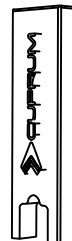

**GN-632**  
TAPA TRASLAPE

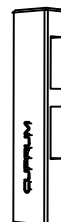

**GN-634**  
TAPA CERCO

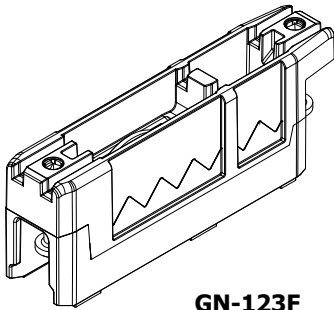

**GN-123F**  
CARRETILLA AJUSTABLE  
(45 KG POR CARRETILLA - 90 POR HOJA)

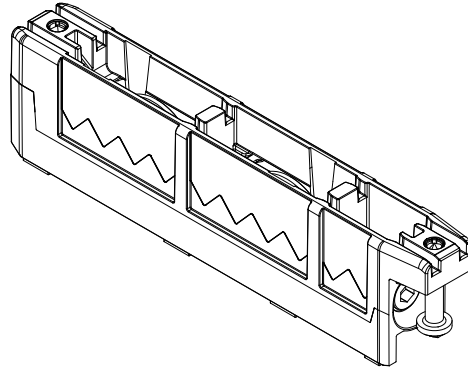

**CAGT103/3ALMF**  
PARA DOBLE VIDRIO PUERTA  
(100 KG POR CARRETILLA - 200 POR HOJA)

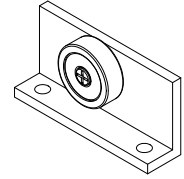

**GN-127**  
CARRETILLA MOSQUITERO

CLASSIC  
SERIE  
**S70**  
COREDIZA

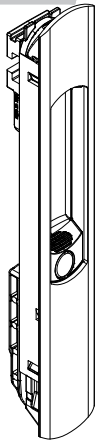

**FN-552**  
BROCHE MINI 160MM  
(EMBUTIDO)

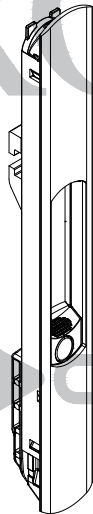

**FN-553**  
BROCHE OLÉ TOP 200MM  
(EMBUTIDO)

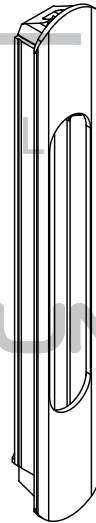

**UA800E4**  
UÑERO EMBUTIDO

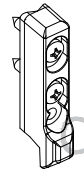

**FN-557C**  
CONTRA

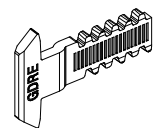

**FN-557B**  
GANCHO

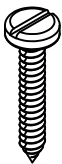

**PFNG-0805**  
#8 X 1/2"

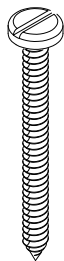

**PFNG-1017**  
# 10 x 1 1/2"

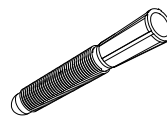

**TAQ1147**  
TAQUETE 1/4 D/PLASTICO

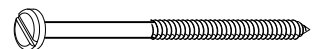

**TMNG-1026**  
TORN P/MADERA 10X76 GAL

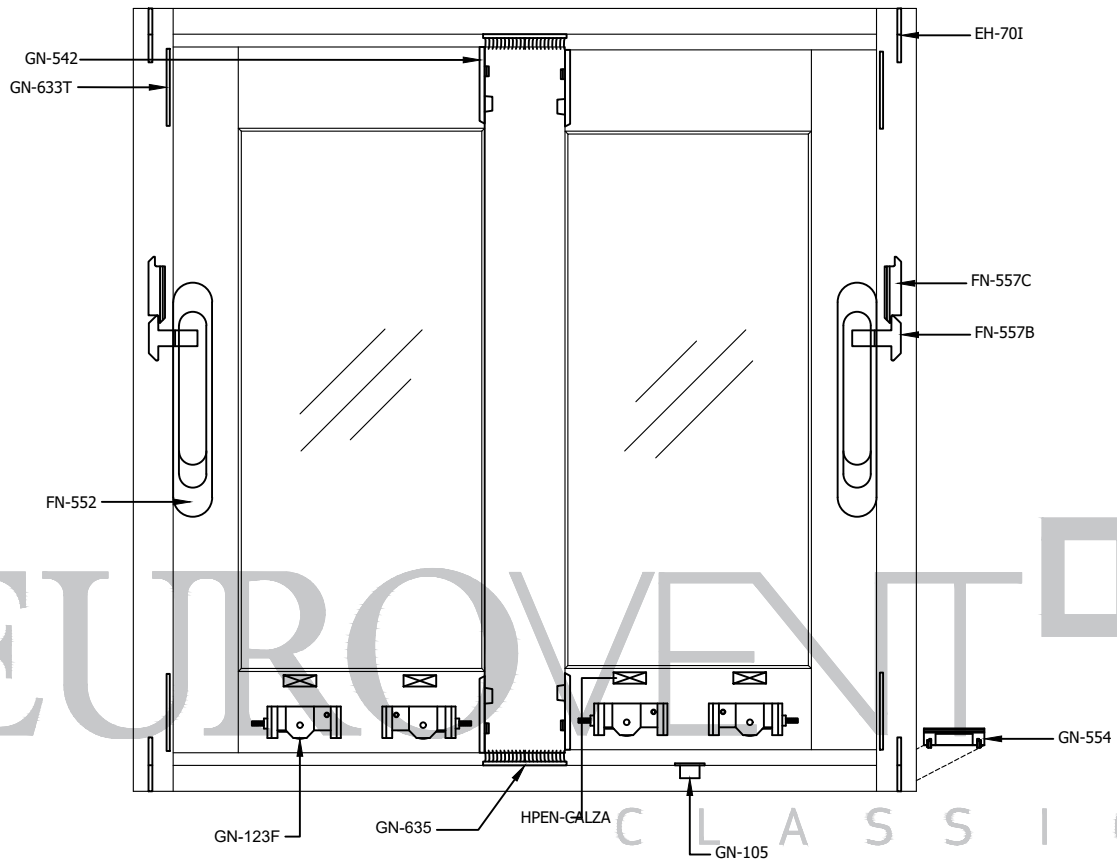

CLASSIC  
SERIE  
**S70**  
CORREDIZA



VENTANA CORREDIZA S70 XX		
CLAVE	DESCRIPCIÓN	PIEZAS
EH-70I	JUNTA DE HERMETICIDAD	4
FN-552	CIERRE CHICO 165 MM	2
FN-557B	FLECHA	2
FN-557C	CONTRA	2
GN-554	TAPA DREN CON VÁLVULA	2
GN-105	TAPÓN DESAGÜE	1
GN-123F	CARRETILLA	4
GN-631T	TAPA TRASLAPE VENTANA	4
GN-633T	TAPA CERCO VENTANA	4
GN-635	CORTAVIENTO	2
PFNG-1017	PIJA #10 X 1 1/2"	24
PFNG-0805	PIJA #8 X 1/2"	8
VN-E2002NE	EMPAQUE COLA DE RATA	1L + 2H
VN-2610NE	VN-E2610NE PARA CRISTAL	2L + 4H
FN-110P	FELPA CON PÁSTICO	4L + 6H
HPEN-CALZA	CALZA DE NEOPRENO	2

MOSQUITERO		
UA800E4	UÑERO PARA MOSQUITERO	2
GN-127	CARRETILLA PARA MOSQUITERO COLGANTE	2
PFNG-1017	PIJA #10 X 1 1/2"	4
PPNG-1020	PIJA #10 X 2"	4
PFNG-0805	PIJA #8 X 1/2" (SUJETAR RIEL MOSQUITERO A RIEL)	3
VN-E2611NE	EMPAQUE ALETA PARA MOSQUITERO	2H
-	TELA MOSQUITERO	-



CLASSIC  
SERIE  
**S70**  
CORREDIZA

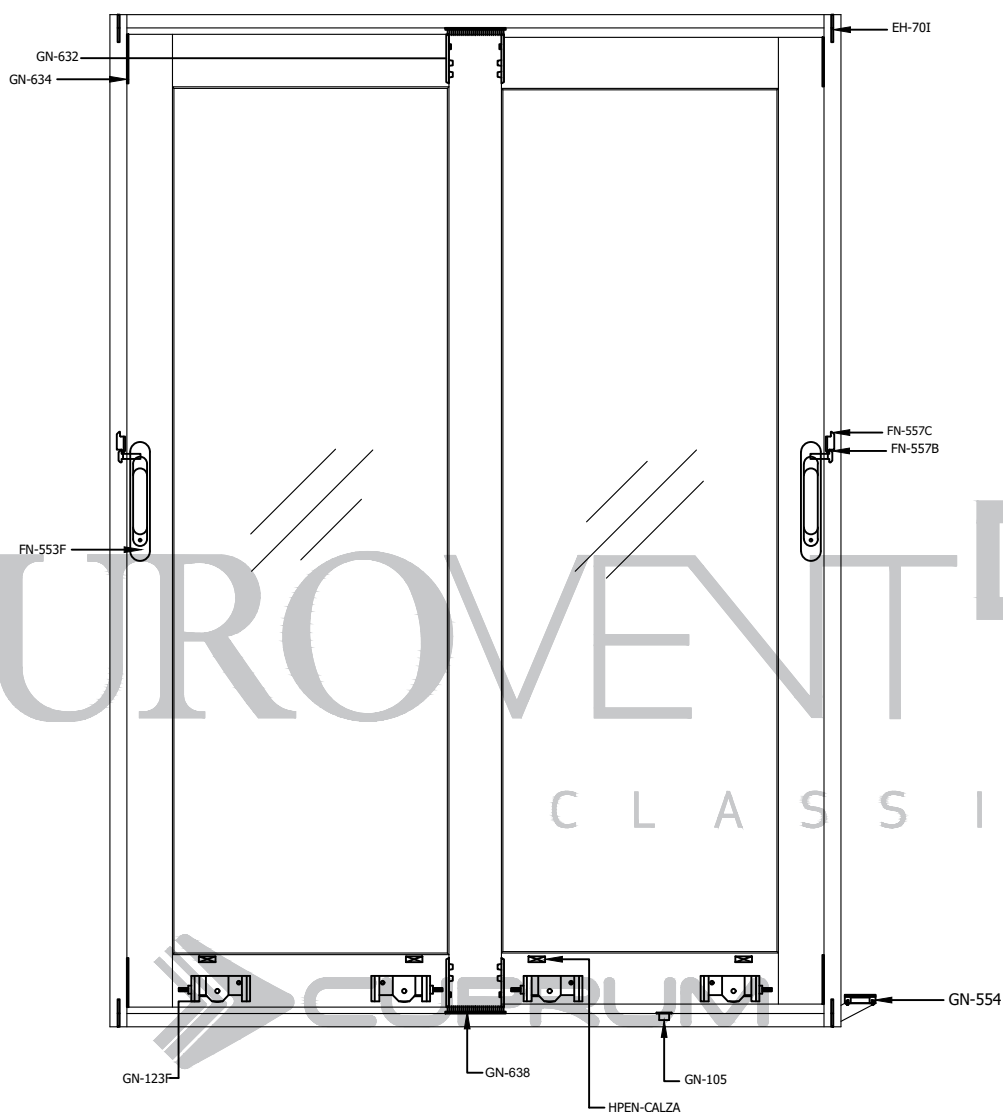

**PUERTA CORREDIZA S70 XX**

CLAVE	DESCRIPCIÓN	PIEZAS
EH-701	JUNTA DE HERMETICIDAD	4
FN-553	CIERRE GRANDE 185 MM	2
FN-557B	FLECHA	2
FN-557C	CONTRA	2
GN-554	TAPA DREN CON VÁLVULA	2
GN-105	TAPÓN DESAGÜE	1
GN-123F	CARRETILLA	4
GN-632	TAPA TRASLAPE PUERTA	4
GN-634	TAPA CERCO PUERTA	4
GN-638	CORTAVIENTO	2
PFNG-1017	PIJA #10 X 1 ½"	24
PFNG-0805	PIJA #8 X ½"	8
VN-E2002NE	EMPAQUE COLA DE RATA	1L + 2H
VN-2610NE	VINIL CUÑA PARA CRISTAL	2L + 4H
FN-110P	FELPA CON PÁSTICO	4L + 6H
HPEN-CALZA	CALZA DE NEOPRENO	2

**MOSQUITERO**

CLAVE	DESCRIPCIÓN	PIEZAS
UA800E4	UÑERO PARA MOSQUITERO	4
GN-127	CARRETILLA PARA MOSQUITERO COLGANTE	2
PFNG-1017	PIJA #10 X 1 ½"	4
PPNG-1020	PIJA #10 X 2"	4
PFNG-0805	PIJA #8 X ½" (SUJETAR RIEL MOSQUITERO A RIEL)	3
VN-E2611NE	EMPAQUE ALETA PARA MOSQUITERO	2H
-	TELA MOSQUITERO	-

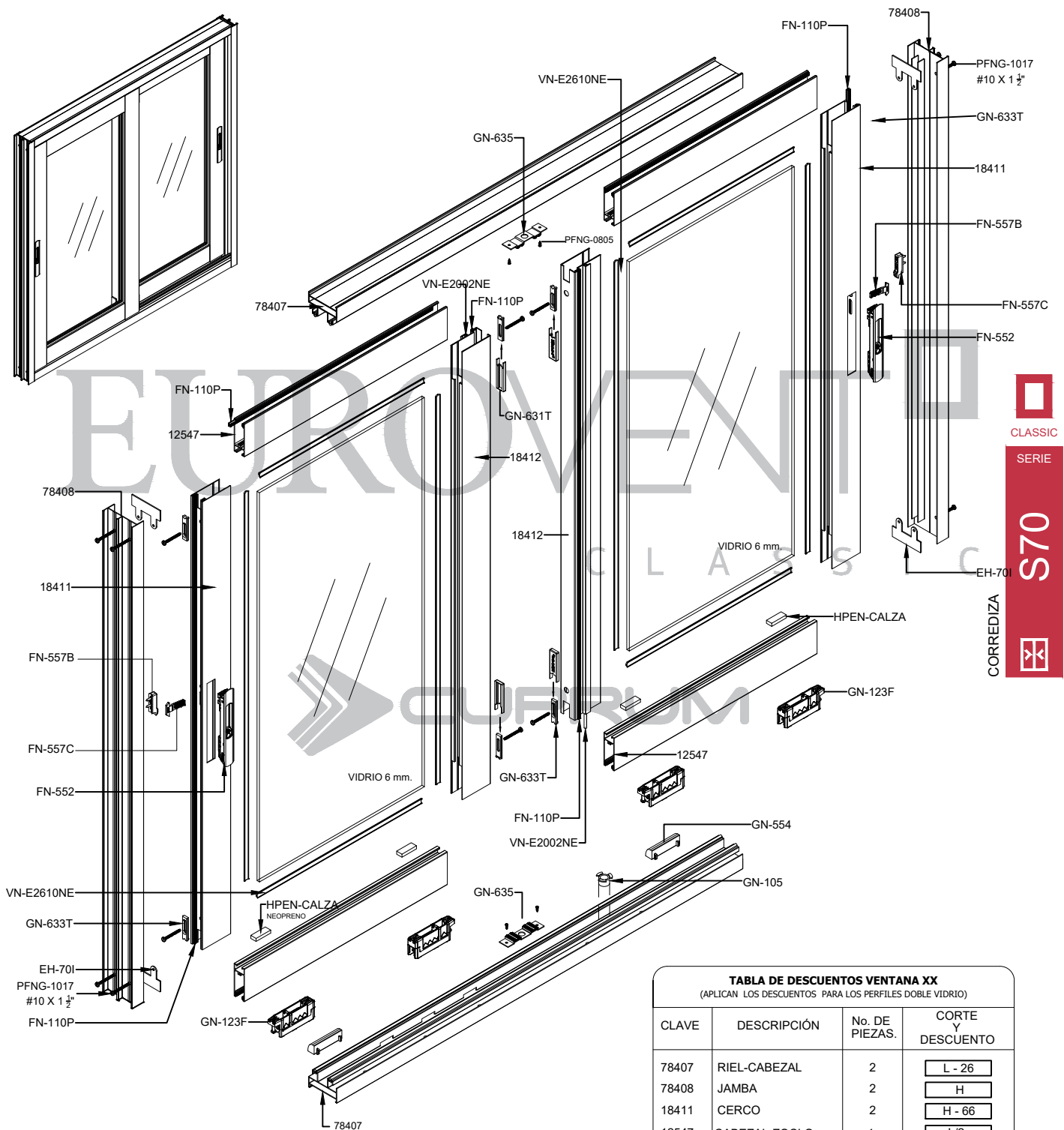

CLASSIC  
SERIE  
**S70**  
CORREDIZA

**HERRAMIENTAS ADICIONALES REQUERIDAS**

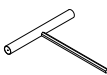

**LLAVE ALLEN 4 MM.** CARRETILLA AJUSTABLE (GN-123F)  
**LLAVE ALLEN 3 MM.** BROCHE MINI 160MM (FN-552)

SIN ESCALA.

**TABLA DE DESCUENTOS VENTANA XX**  
(APLICAN LOS DESCUENTOS PARA LOS PERFILES DOBLE VIDRIO)

CLAVE	DESCRIPCIÓN	No. DE PIEZAS.	CORTE Y DESCUENTO
78407	RIEL-CABEZAL	2	L - 26
78408	JAMBA	2	H
18411	CERCO	2	H - 66
12547	CABEZAL-ZOCLO	4	L/2
78412	TRASLAPE	2	H - 66
VIDRIO	L	2	L/2 - 104
	H		H - 191

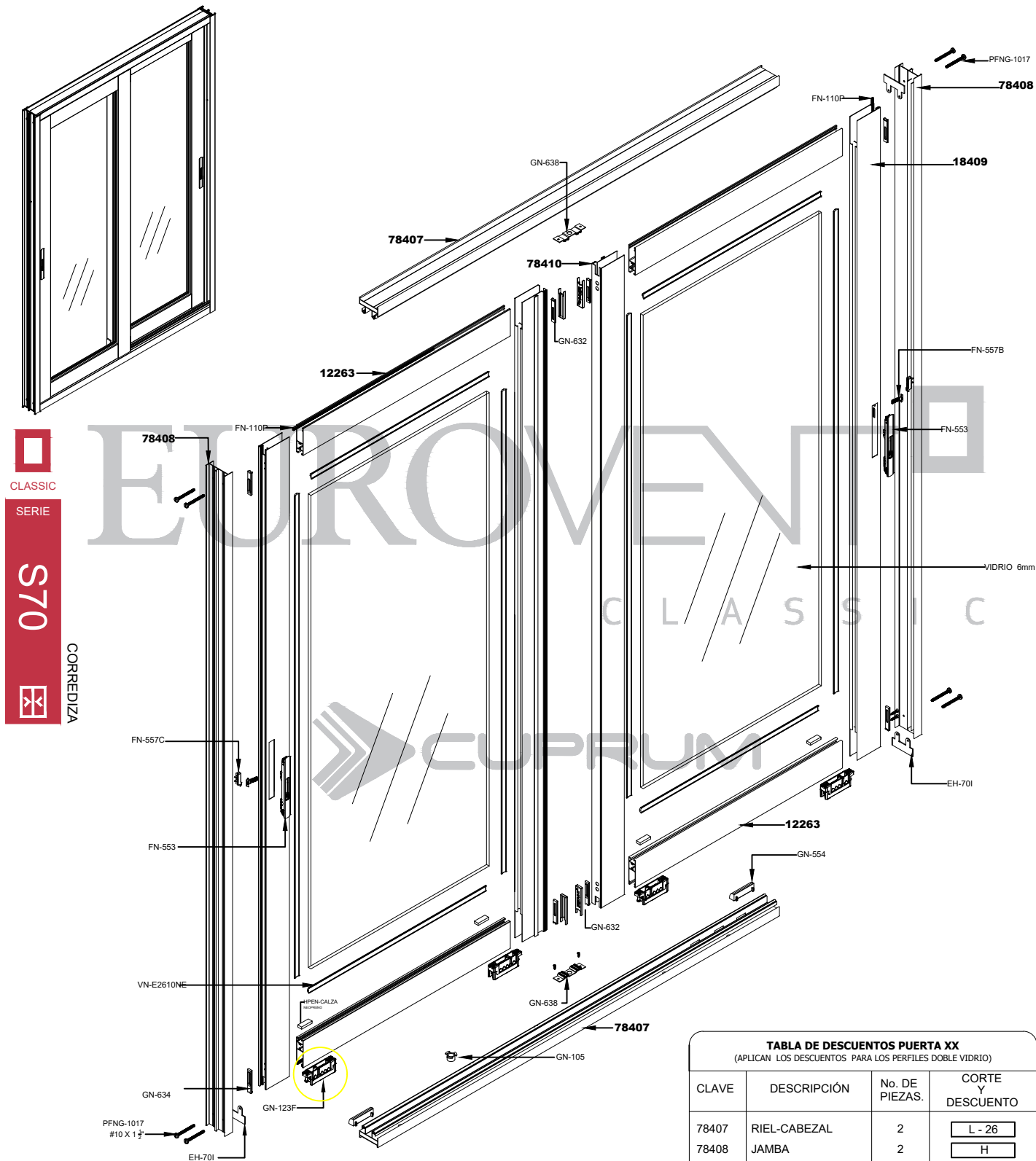
L = ANCHO DE CANCEL  
H = ALTO DE CANCEL  
DESCUENTOS EN MILÍMETROS



CLASSIC  
SERIE  
**S70**  
CORREDIZA

**HERRAMIENTAS ADICIONALES REQUERIDAS**



 LLAVE ALLEN 4 MM. CARRETTILLA AJUSTABLE (GN-123F)  
 LLAVE ALLEN 3 MM. BROCHE OLÉ TOP 200MM (FN-553)

TABLA DE DESCUENTOS PUERTA XX (APLICAN LOS DESCUENTOS PARA LOS PERFILES DOBLE VIDRIO)			
CLAVE	DESCRIPCIÓN	No. DE PIEZAS.	CORTE Y DESCUENTO
78407	RIEL-CABEZAL	2	L - 26
78408	JAMBA	2	H
18409	CERCO	2	H - 66
12263	CABEZAL-ZOCLO	4	L/2 + 9
78410	TRASLAPE	2	H - 66
VIDRIO	L	2	L/2 - 128
	H		H - 220
L = ANCHO DE CANCEL H = ALTO DE CANCEL			DESCUENTOS EN MILÍMETROS

DEFLEXIÓN MAX. L/175

VENTANA CORREDIZA SERIE 70

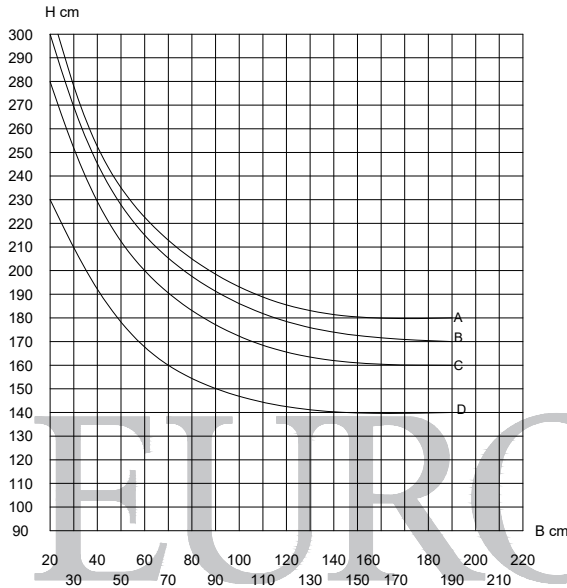

PUERTA CORREDIZA SERIE 70

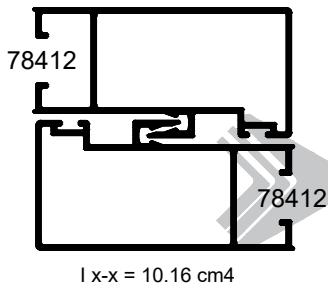
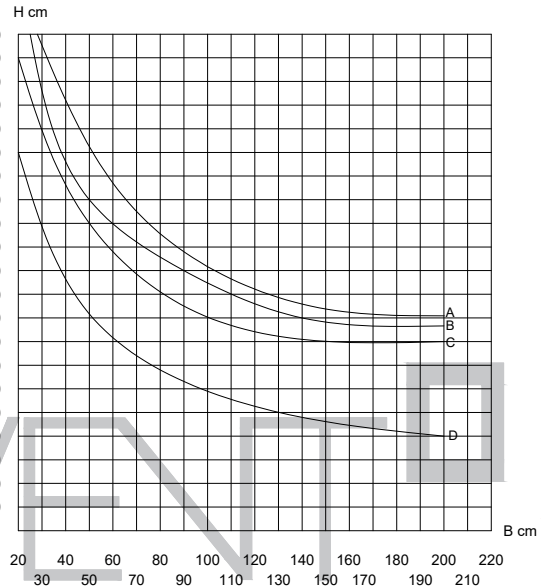

LOS LÍMITES DE FABRICACIÓN PARA LOS PERFILES, SERÁN LOS QUE SE ENCUENTREN DEBAJO DE LAS CURVAS GRAFICADAS.

ALEACIÓN: 6063  
TEMPLE: 5

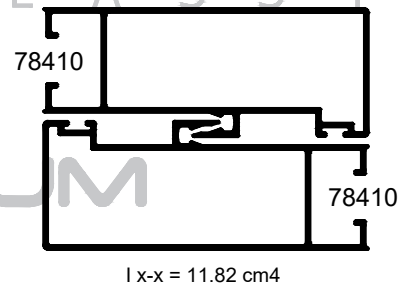

CLASSIC  
SERIE  
S70  
CORREDIZA

Valores de presión por velocidad de viento

Curvas	Presión del diseño	Velocidad de viento	Zona
A	45 Kg/m <sup>2</sup>	80 Km/h	Centro de grandes ciudades
B	50 Kg/m <sup>2</sup>	90 Km/h	Barrios Residenciales
C	65 Kg/m <sup>2</sup>	120 Km/h	Campo Abierto
D	145 Kg/m <sup>2</sup>	160 Km/h	Zona Costera

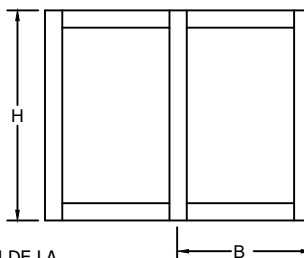

LOS LÍMITES DE UN CANCEL VAN EN FUNCIÓN DE LA COMBINACIÓN DE RESISTENCIA DEL PERFIL DE ALUMINIO, EL VIDRIO Y LOS ACCESORIOS QUE LO INTEGRAN.

VERIFICAR QUE LA DEFLEXIÓN DEL PERFIL SEA COMPATIBLE CON EL VIDRIO UTILIZADO.

PARÁMETROS MÍNIMOS Y MÁXIMOS DE FABRICACIÓN.

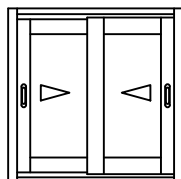

VC-70  
MÍNIMO 0.50 x 0.60 HOJA  
MÁXIMO 1.20 x 1.80 HOJA

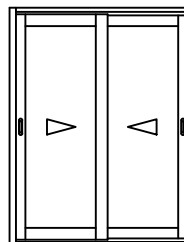

PC-70  
MÍNIMO 0.80 x 1.80 HOJA  
MÁXIMO 1.20 x 2.40 HOJA

CLASSIC  
SERIE  
**S70**  
COREDIZA

ALUMINIO					
CLAVE	DESCRIPCIÓN	PIEZAS X ATADO	LARGO STD. MTS.	PERÍMETRO ANOD. CM.	PERÍMETRO PUL. CM.
11409	CABEZAL	12	6.10	18.30	7.30
11411	MOSQUITERO	8	6.10	14.17	11.36
12263	ZOCLO-CABEZAL	4	6.10	39.29	19.26
12428	BOTAGUAS	28	6.10	9.99	8.18
12437	ZOCLO-CABEZAL DOBLE VIDRIO	4	6.10	37.22	19.00
12456	INTERMEDIO	8	6.10	23.33	9.53
12547	ZOCLO-CABEZAL	8	6.10	38.54	16.74
12664	ZOCLO-CABEZAL DOBLE VIDRIO	6	6.10	36.46	15.39
14411	REFUERZO 1/2"	16	6.10	14.35	11.06
14412	CONECTOR	29	6.10	3.22	0.62
14702	PERFIL P/CUADRICULA	20	6.10	14.83	4.11
14918	PERFIL P/CUADRICULA	16	6.10	20.84	7.82
18408	JAMBA	6	6.10	35.58	22.86
18409	CERCO	6	5.00	32.53	25.30
18411	CERCO	4	5.00	28.96	21.73
18413	GUÍA INFERIOR	12	6.10	15.91	13.08
18419	CERCO DOBLE VIDRIO	4	6.10	30.10	24.53
18421	CERCO DOBLE VIDRIO	4	6.10	26.53	20.96
50701	ADAPTADOR OXXO	30	6.10	9.17	4.20
62374	JAMBA	4	6.10	55.82	36.74
72373	RIEL TRIPLE	2	6.10	50.53	26.83
78407	RIEL-CABEZAL	4	6.10	40.04	19.52
78408	JAMBA	8	6.10	34.95	5.64
78410	TRASLAPE	4	5.00	34.29	21.38
78412	TRASLAPE	4	6.10	30.71	17.81
78420	TRASLAPE DOBLE VIDRIO	4	5.00	31.86	21.38
78422	TRASLAPE DOBLE VIDRIO	4	6.10	28.29	17.81



Este manual esta protegido bajo varias patentes y diseños en tramite.  
Prohibida su reproducción total o parcial.

