

CORREDIZA SERIE 50

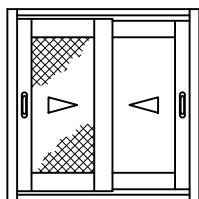

X X

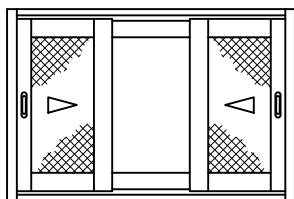

X O X

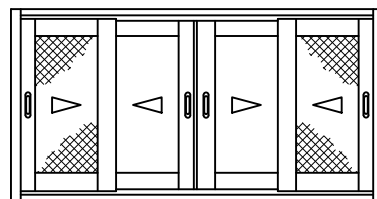

X X X X



CLASSIC

SERIE

S50

CORREDIZA



EUROVENT

CLASSIC

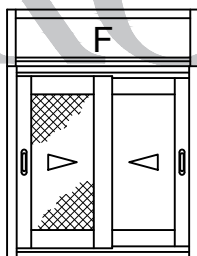

X X

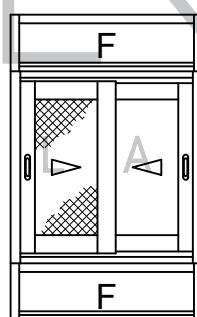

X X



CUPRUM

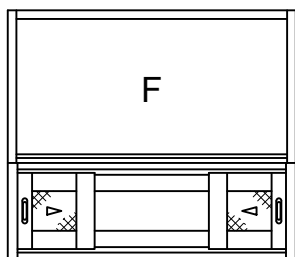
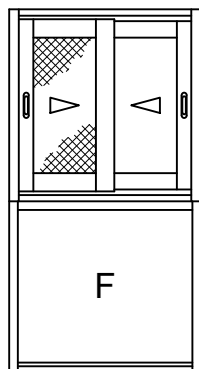

X O X

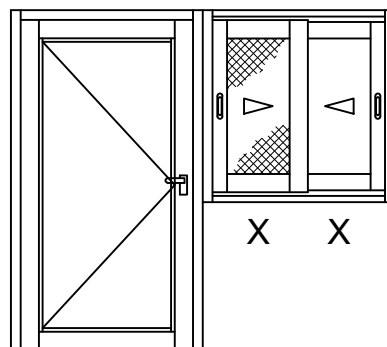

X X

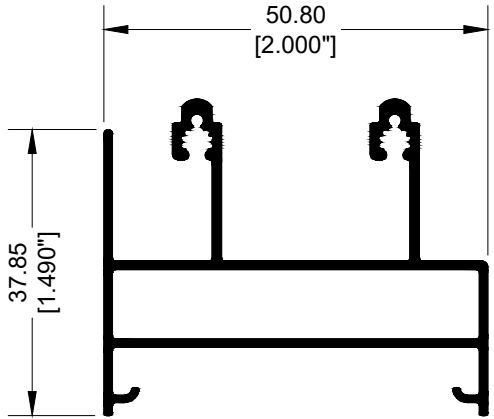

**68842**  
RIEL CABEZAL

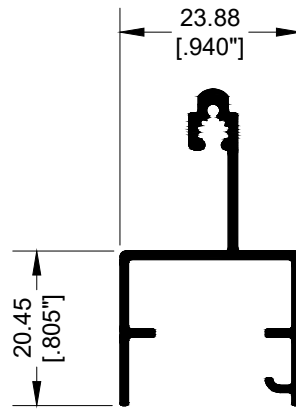

**68846**  
EXTENSION  
RIEL

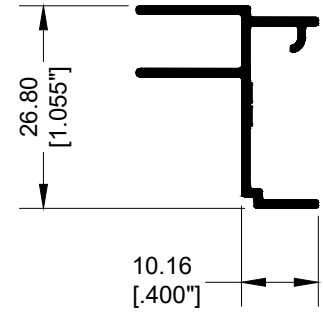

**68847**  
EXTENSION  
JAMBA

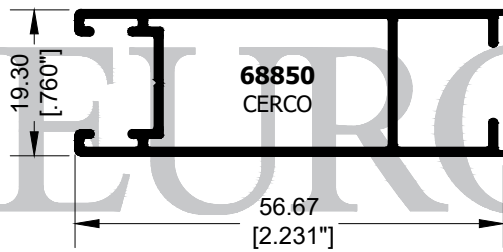

**68850**  
CERCO

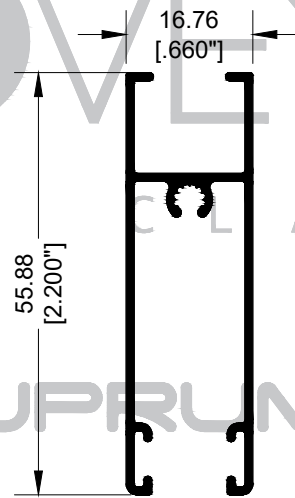

**68843**  
ZOCLO

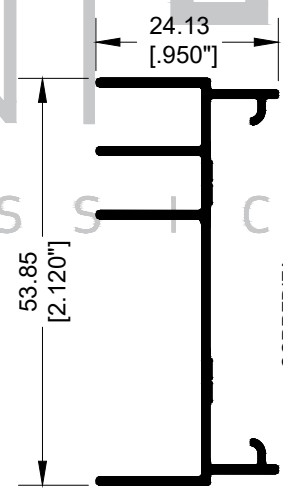

**68844**  
JAMBA

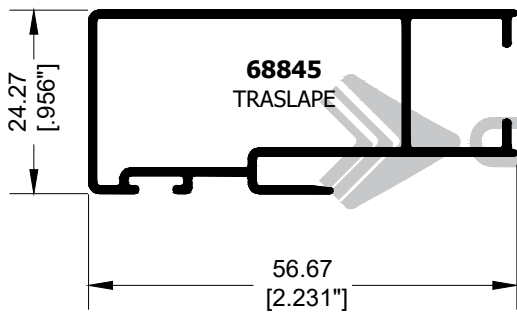

**68845**  
TRASLAPE

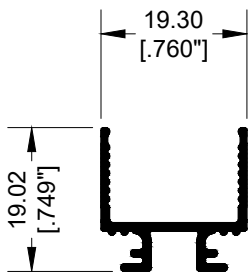

**69356**  
ADAPTADOR  
DOBLE VIDRIO

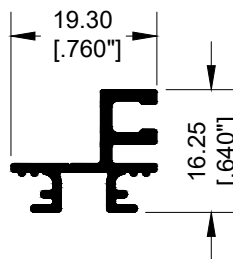

**69368**  
ADAPTADOR  
MOSQUITERO

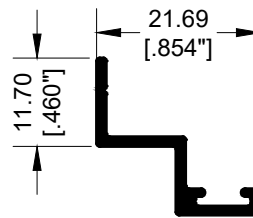

**50701**  
ADAPTADOR  
OXXO

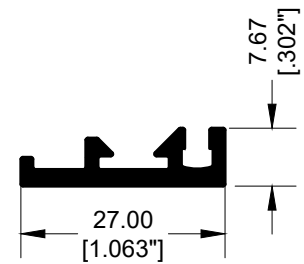

**5173**  
MOSQUITERO



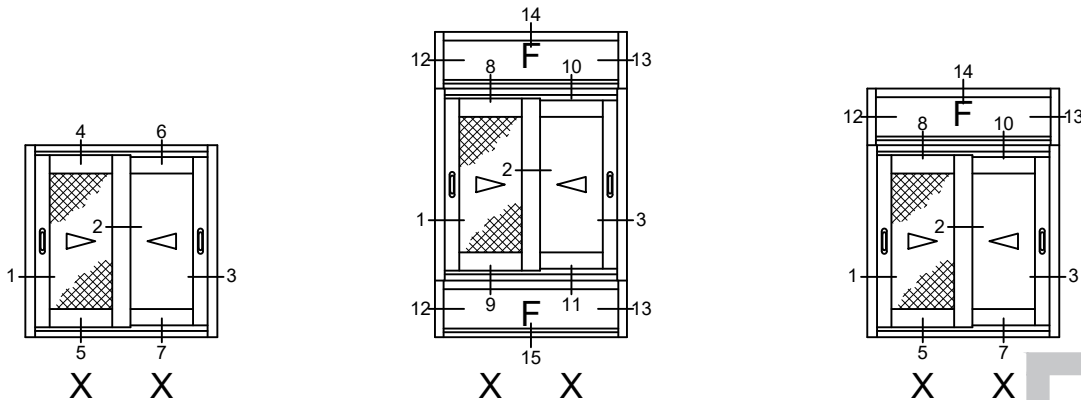

CLASSIC  
SERIE

S50



CORREDIZA

EUROVENT<sup>®</sup>

C L A S S I C

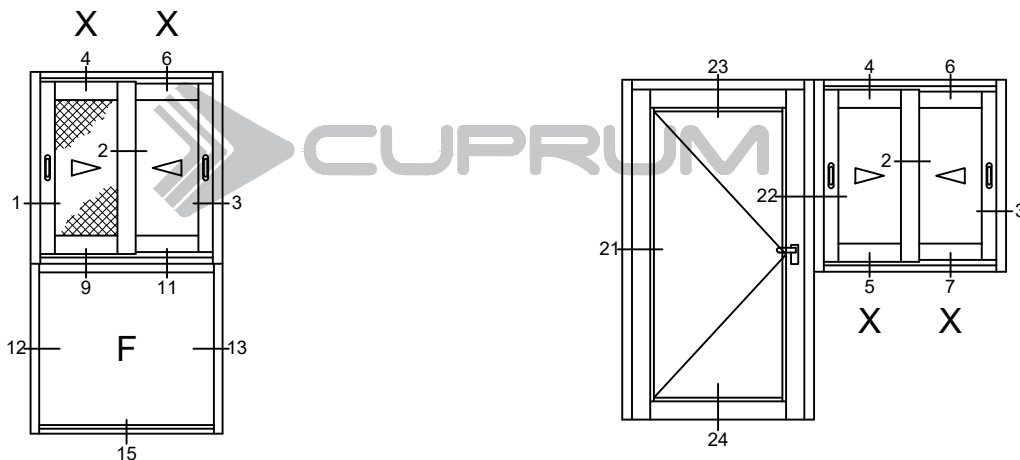

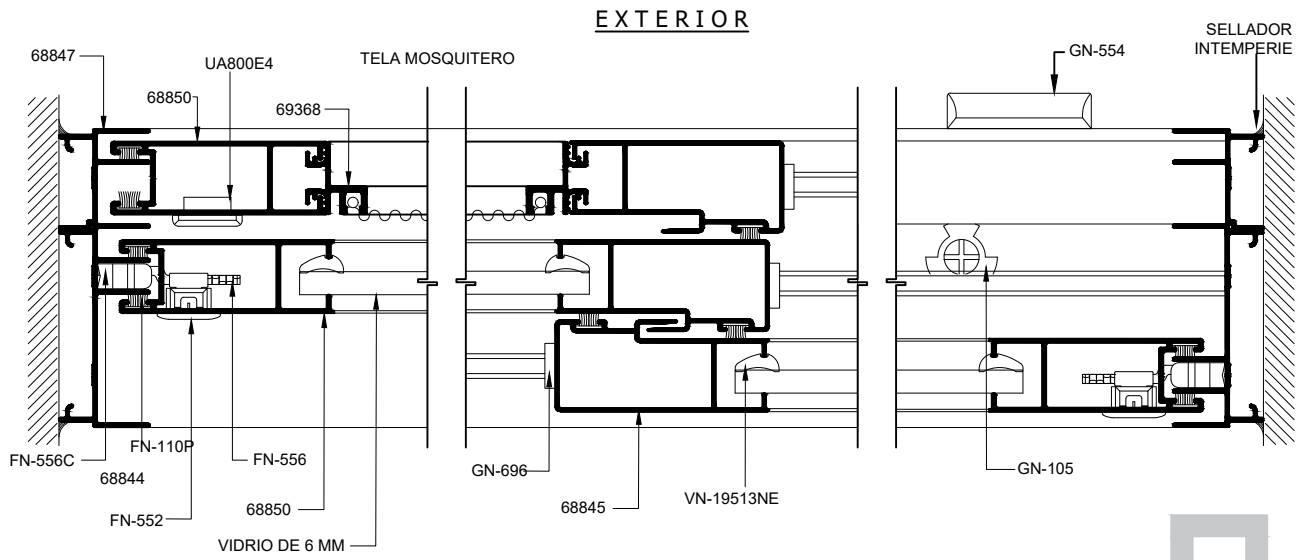

EUROVENT

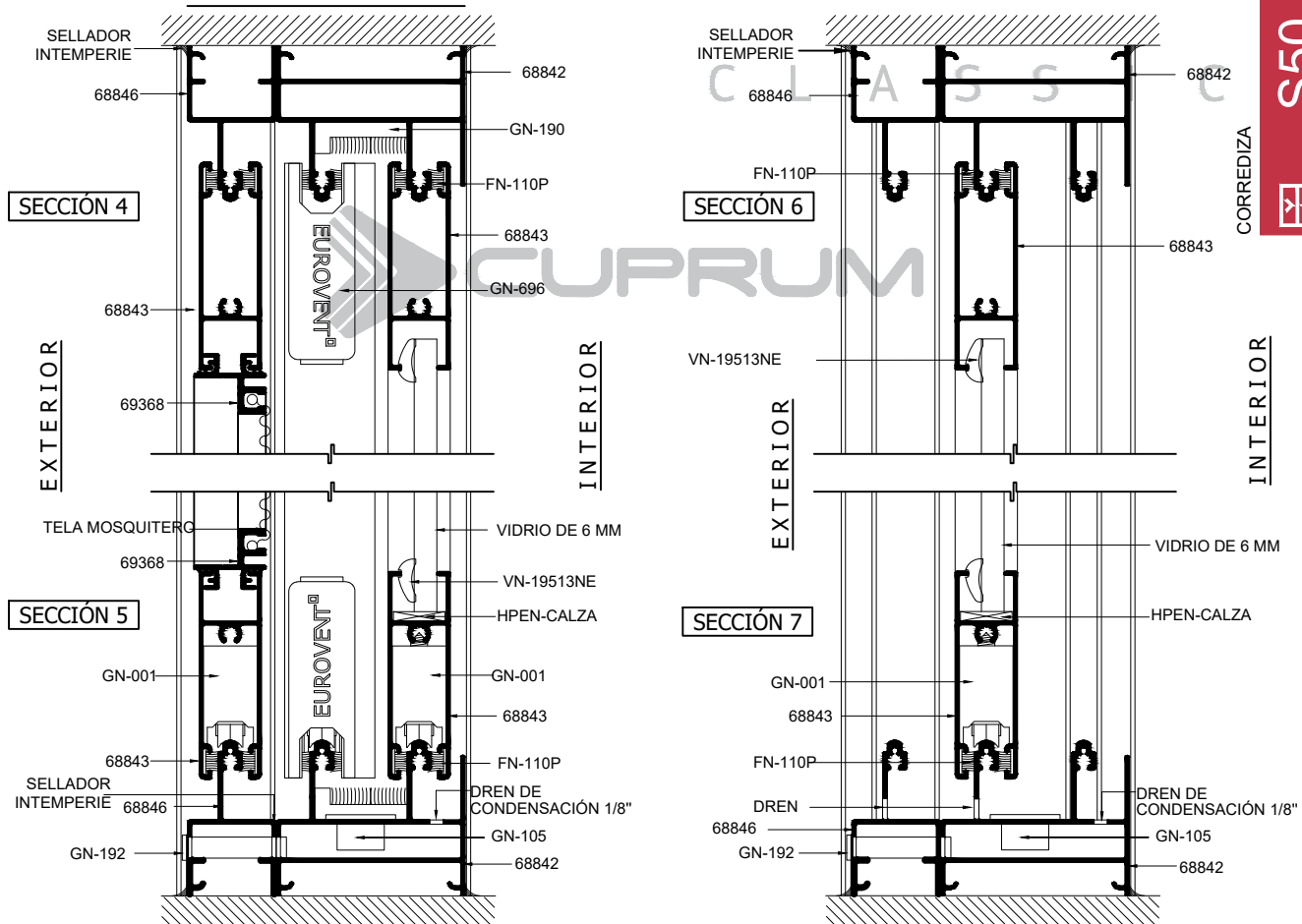

CLASSIC  
SERIE  
**S50**

CORREDIZA

CLASSIC  
SERIE  
**S50**

CORREDIZA

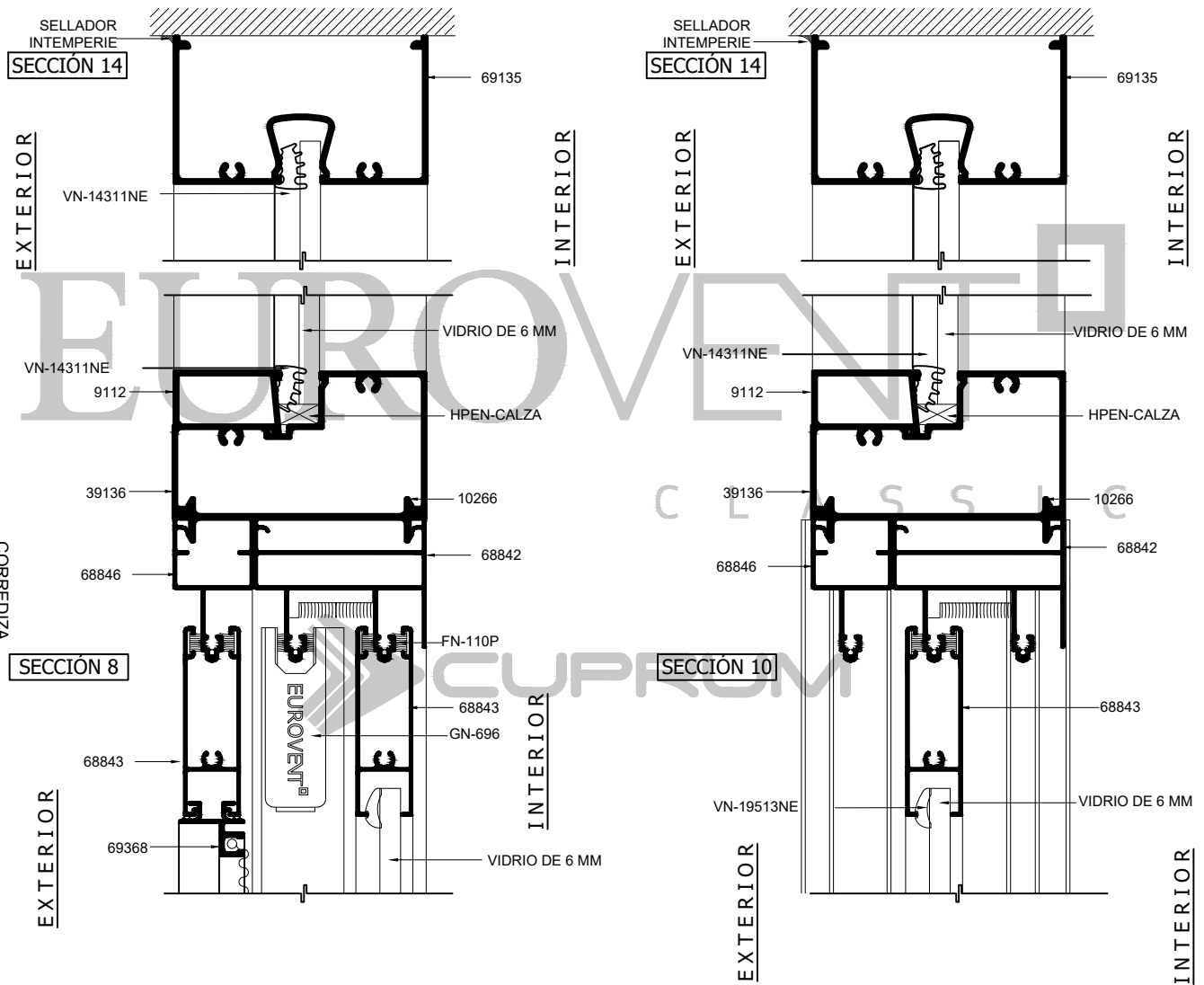

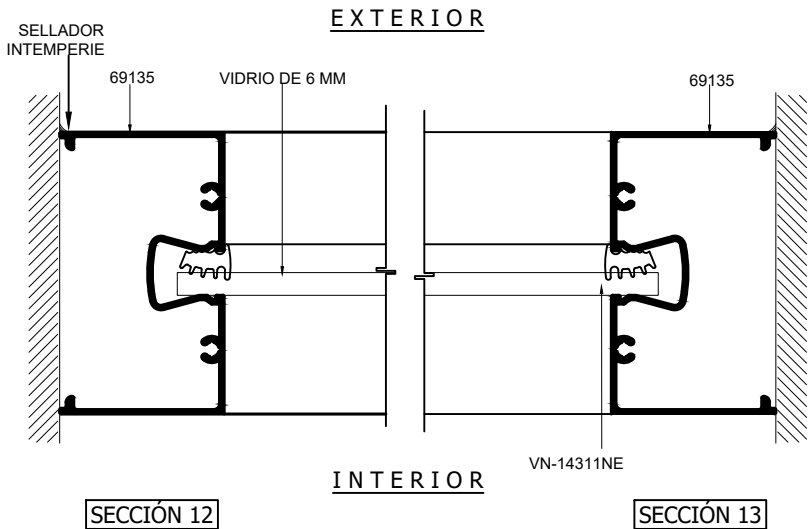
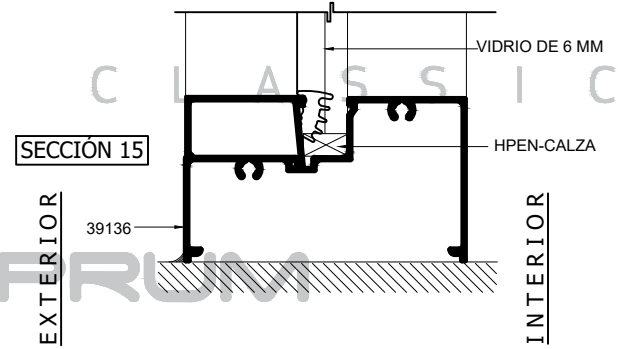
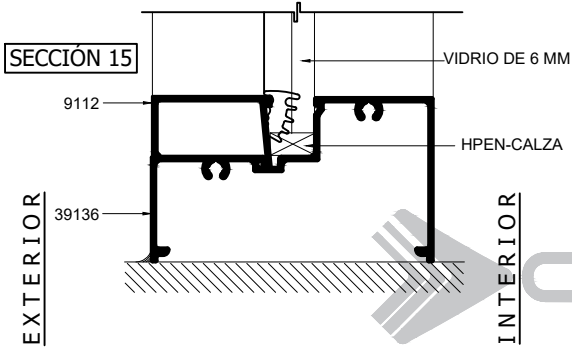
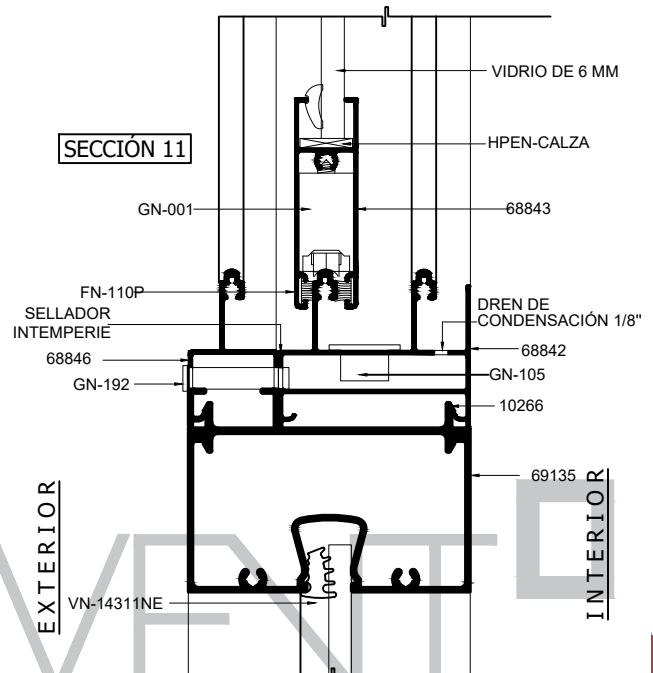
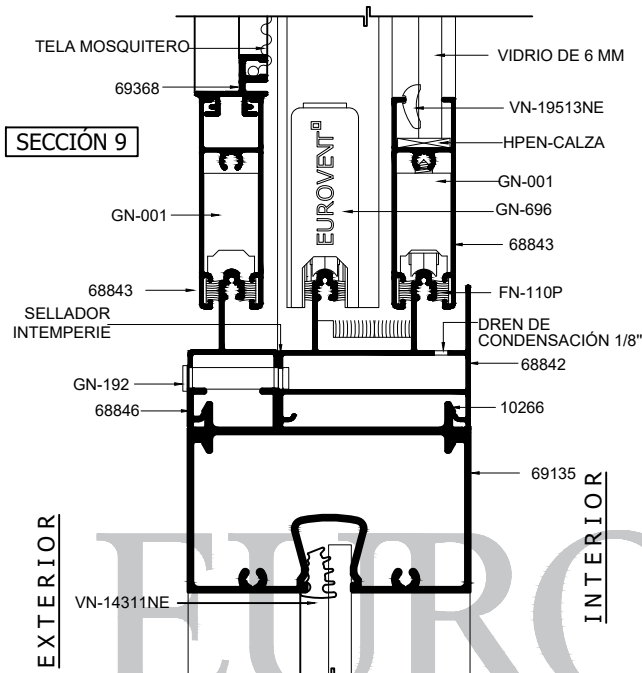

CLASSIC  
SERIE  
**S50**  
CORREDIZA

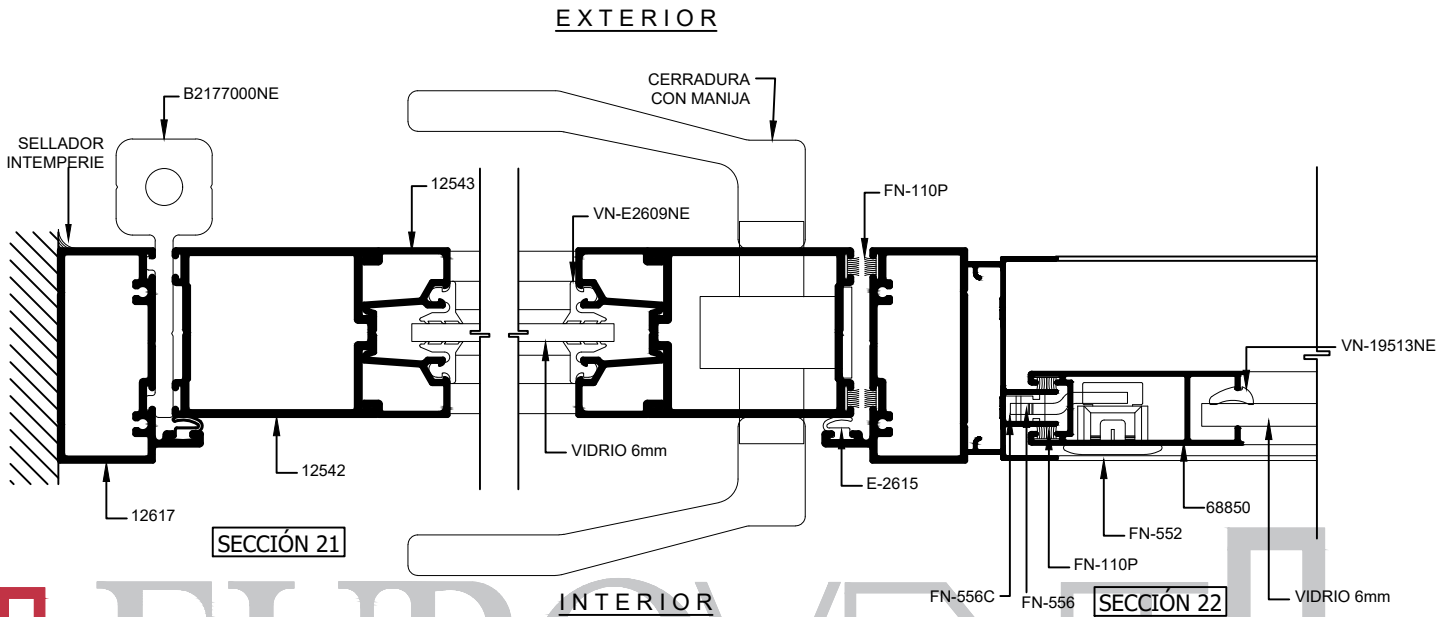

CLASSIC  
SERIE  
**S50**  
CORREDIZA

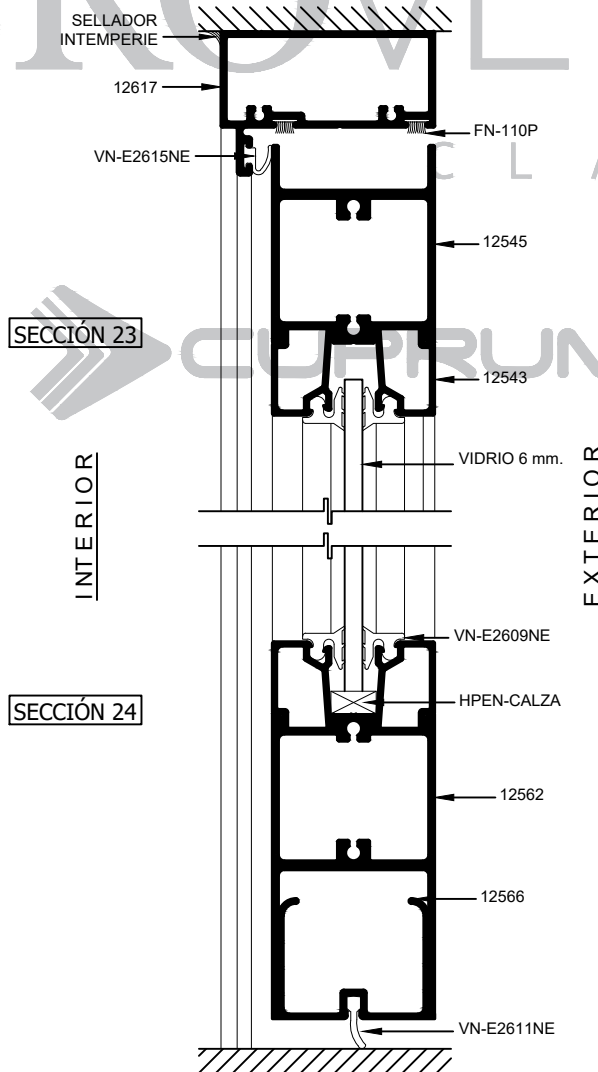



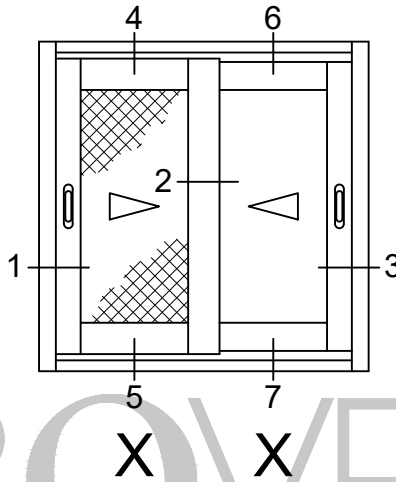

EUROVENT CLASSIC



CLASSIC

SERIE

S50

CORREDIZA



EXTERIOR

SELLADOR INTEMPERIE

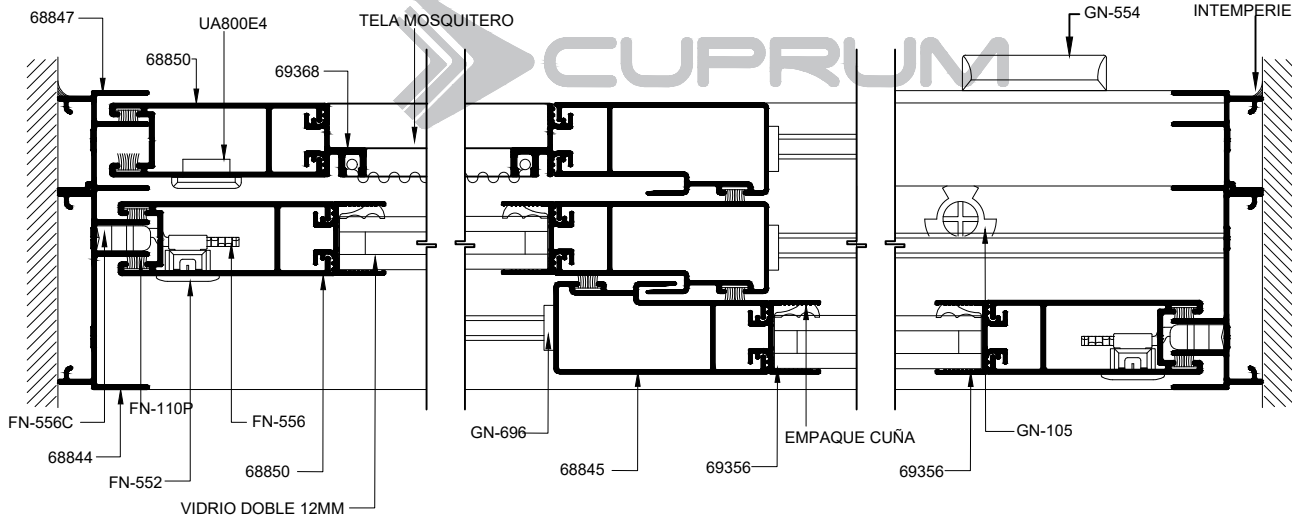

SECCIÓN 1

INTERIOR

SECCIÓN 2

SECCIÓN 3

CLASSIC  
SERIE  
**S50**  
CORREDIZA

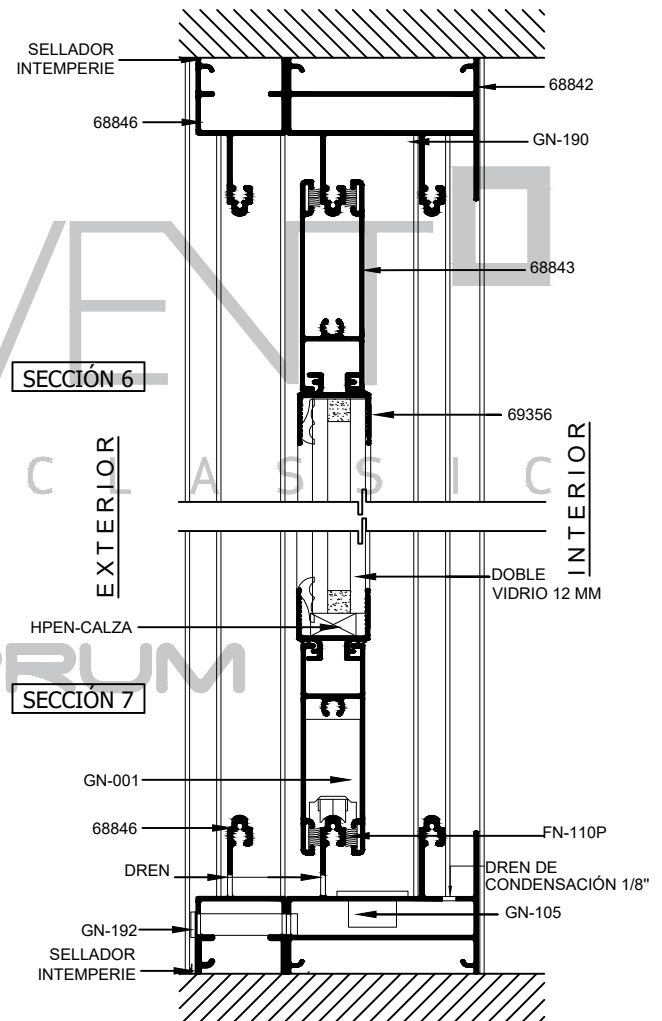
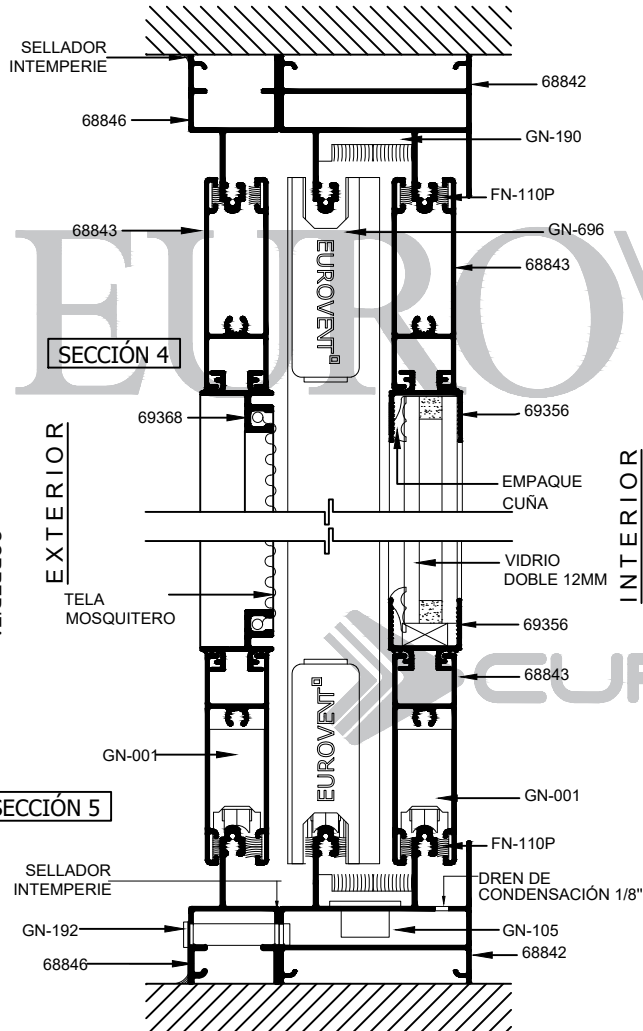

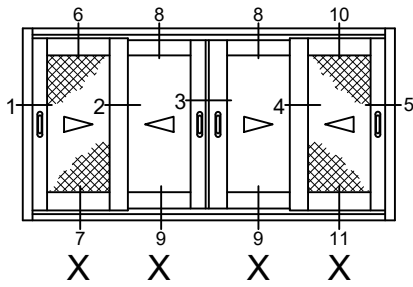

ELEVACIONES TIPO

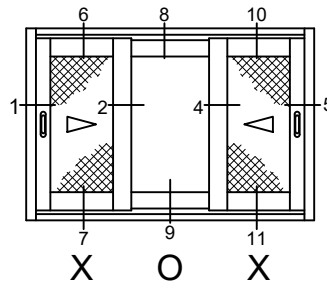

SIN ESCALA

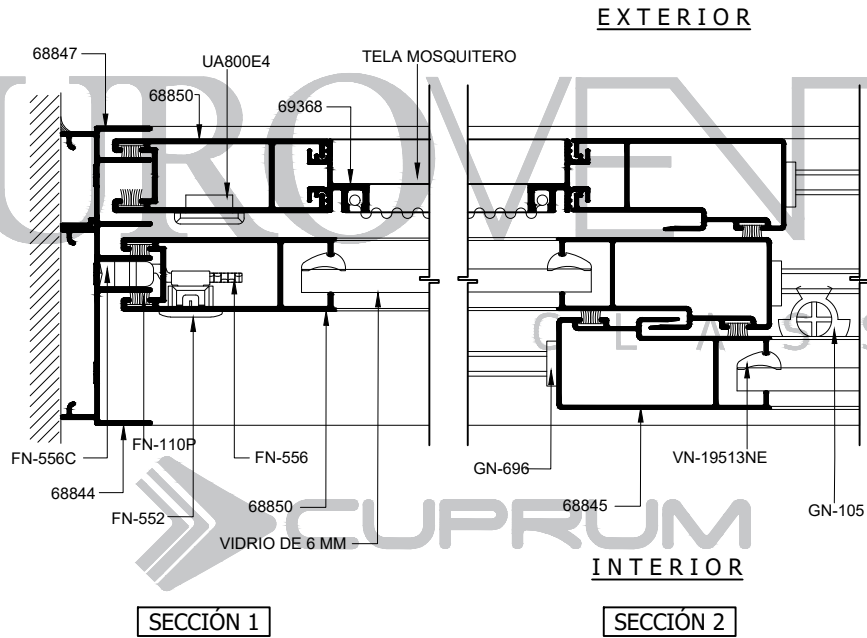
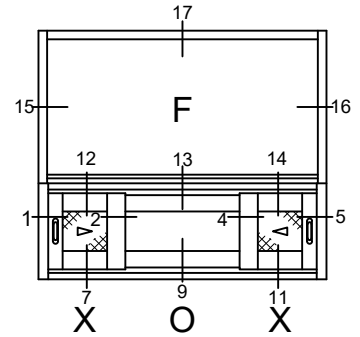

SECCIÓN 1

SECCIÓN 2

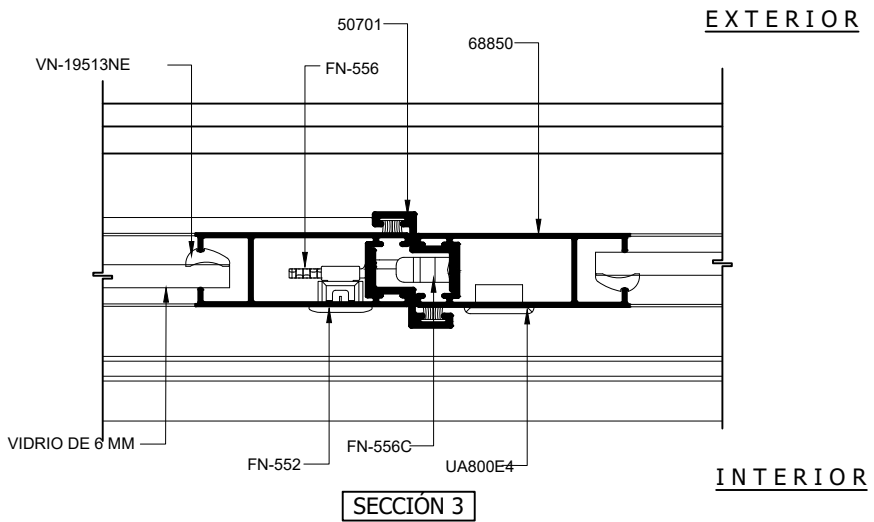

SECCIÓN 3

CLASSIC  
SERIE  
**S50**  
CORREDIZA

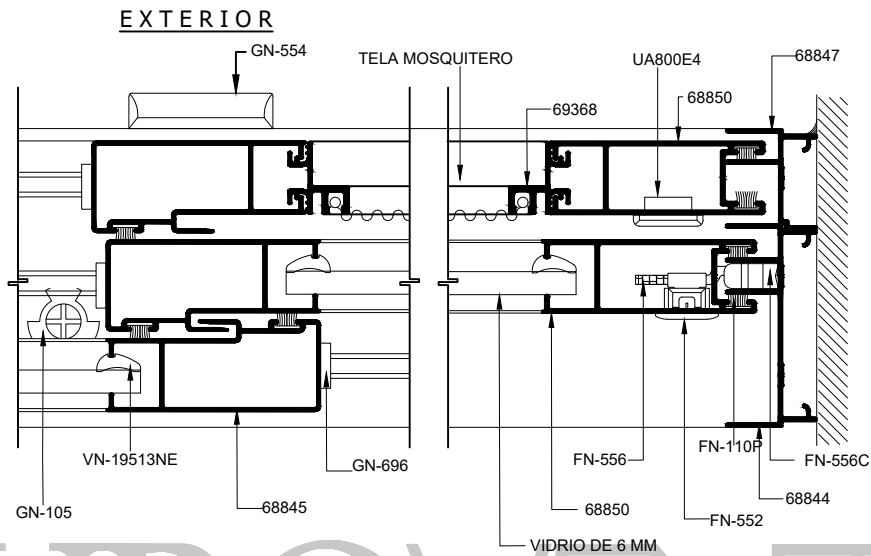

EUROVENT<sup>®</sup>

CLASSIC  
SERIE  
**S50**  
CORREDIZA

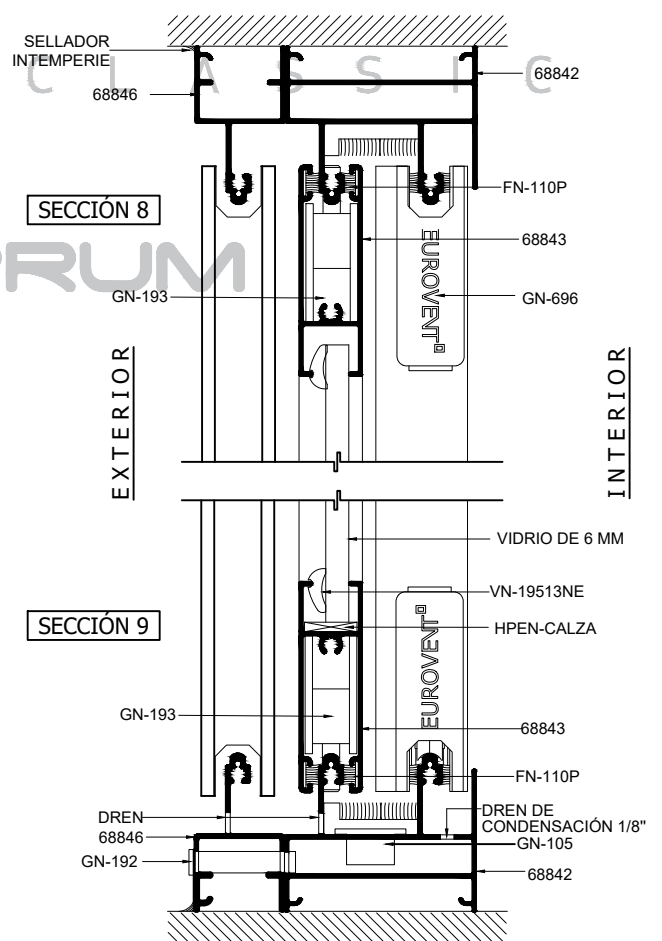
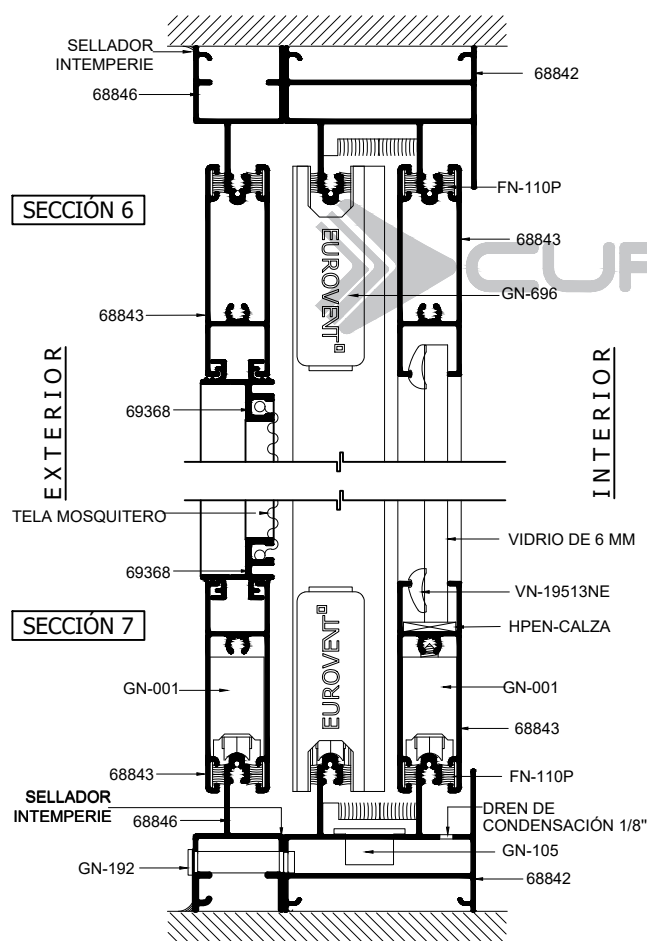

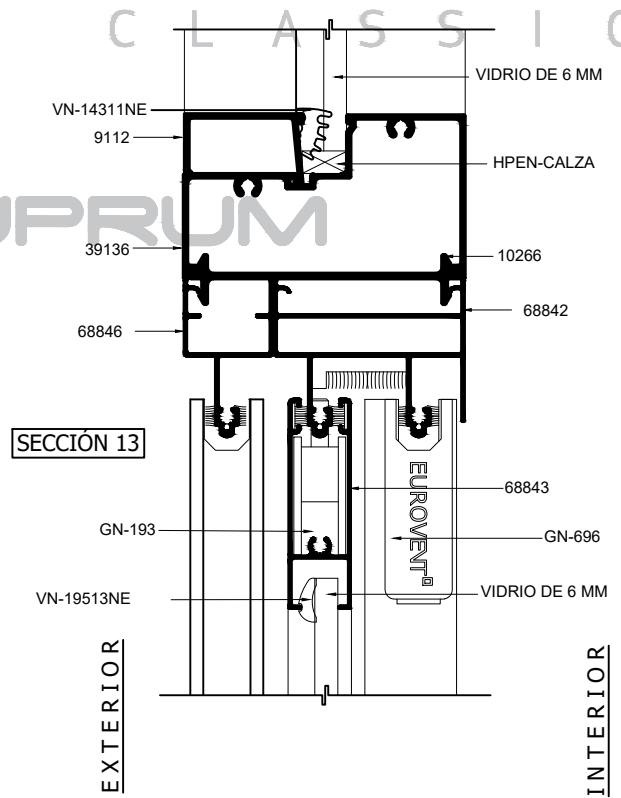
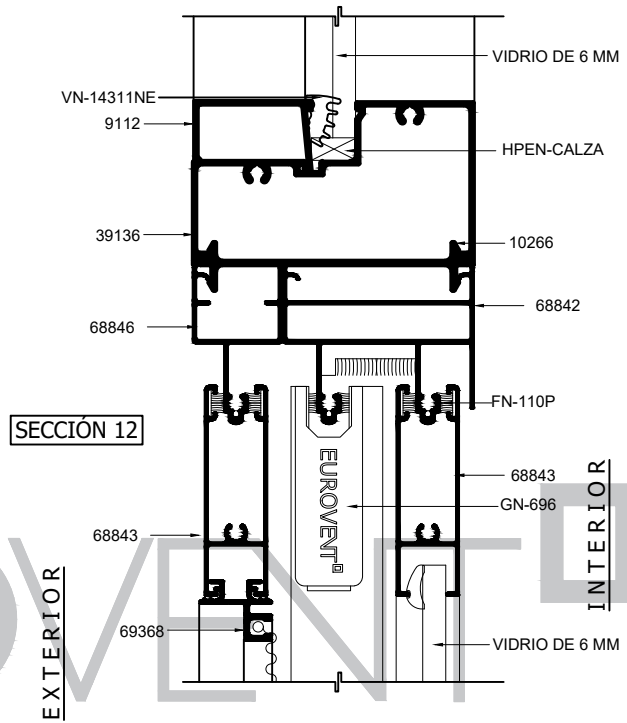
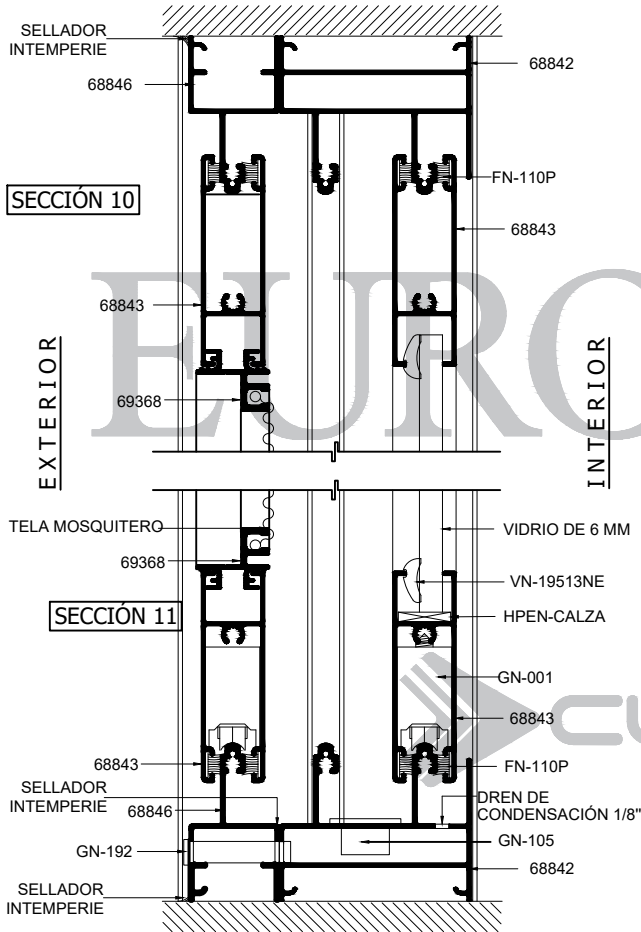

CLASSIC

SERIE

S50



CORREDIZA

  
 CLASSIC  
 SERIE  
**S50**  
  
 CORREDIZA

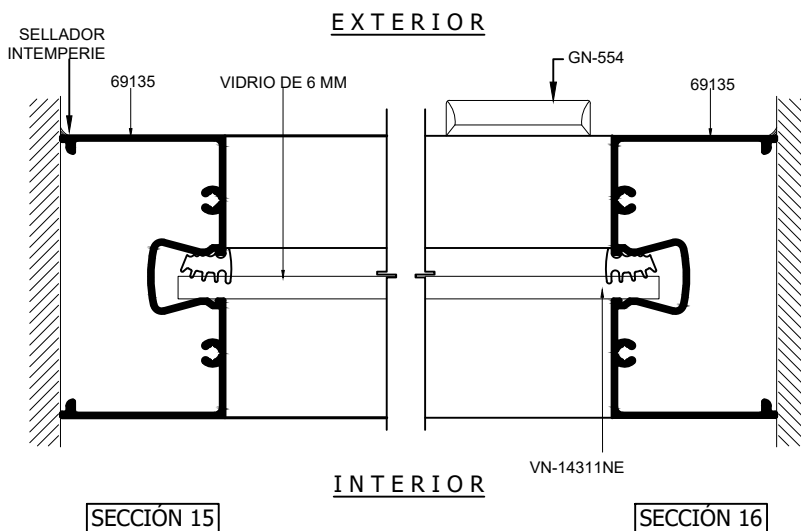
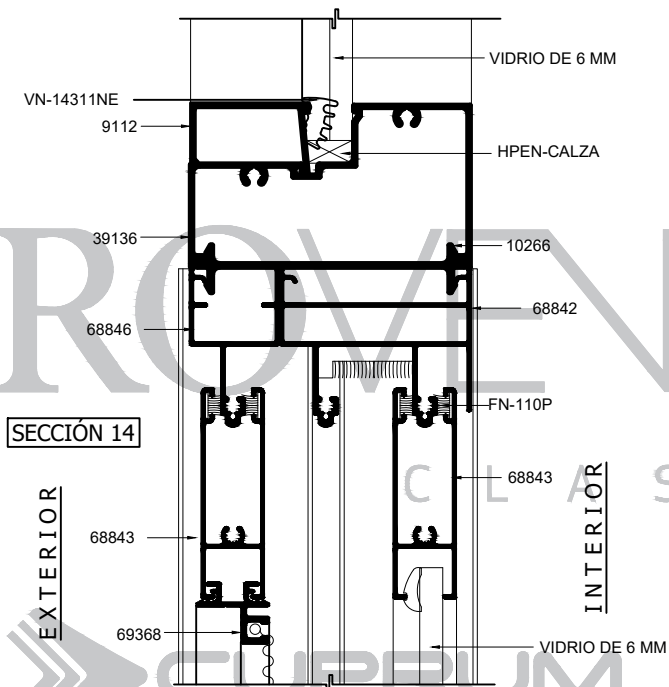
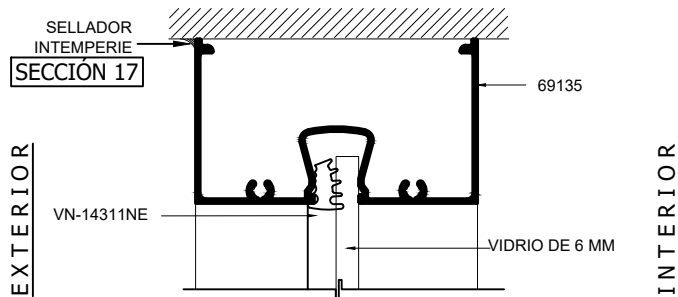

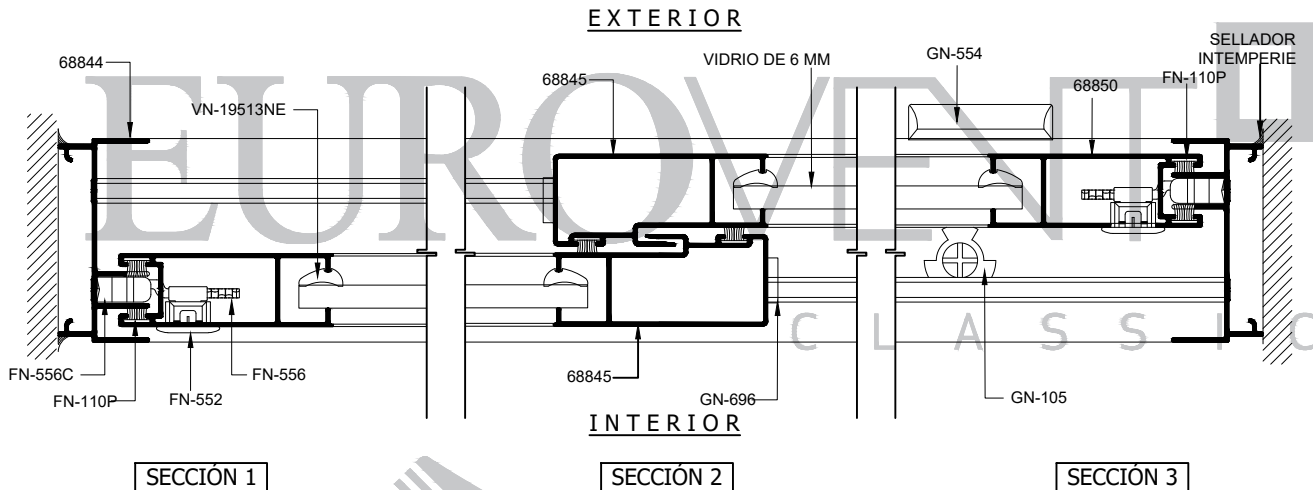
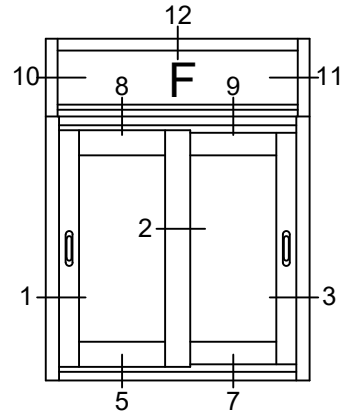
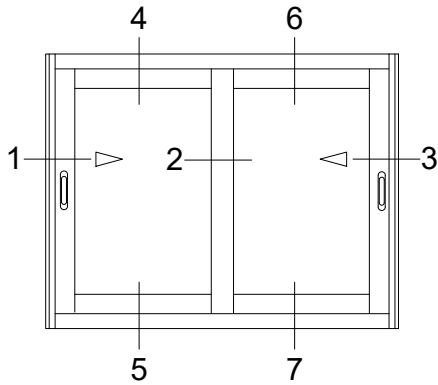

CORREDIZA

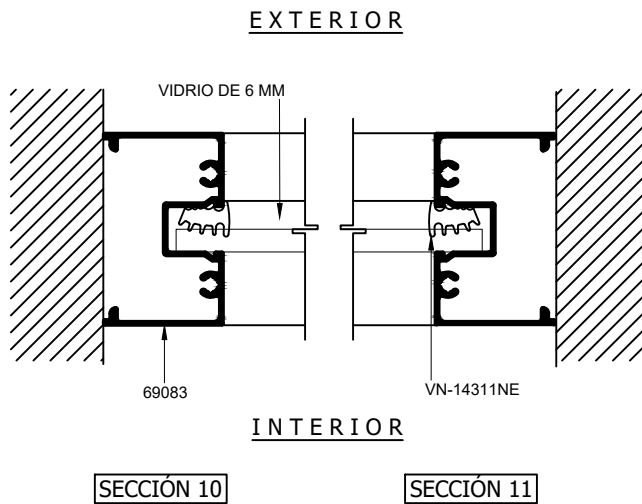

CLASSIC  
SERIE  
**S50**  
CORREDIZA

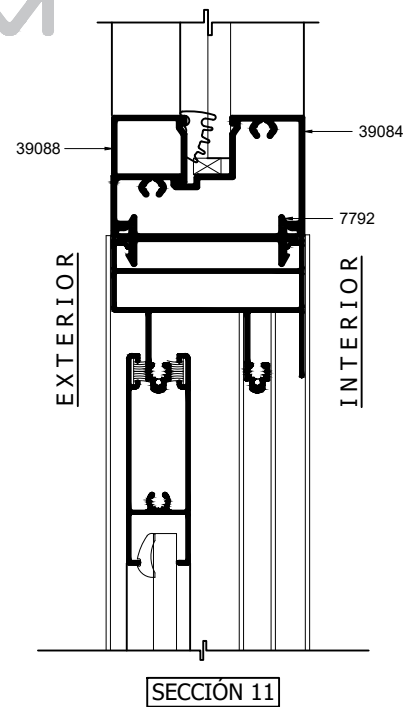
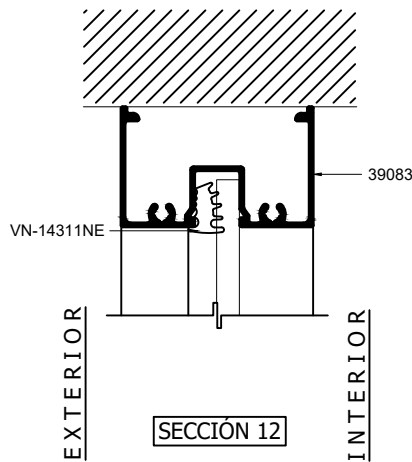
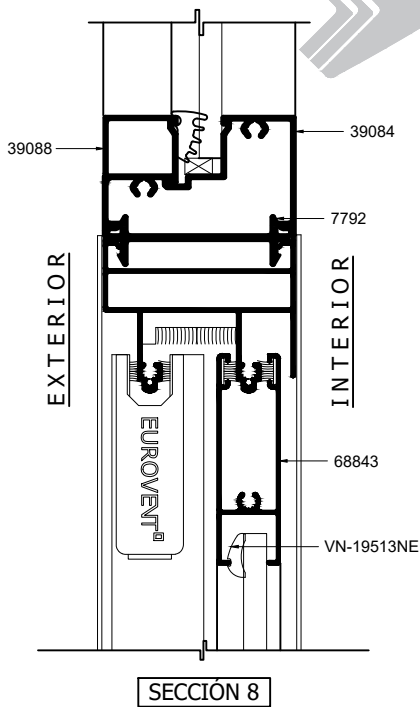
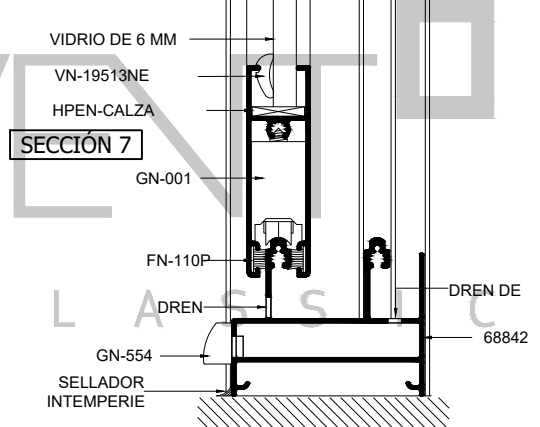
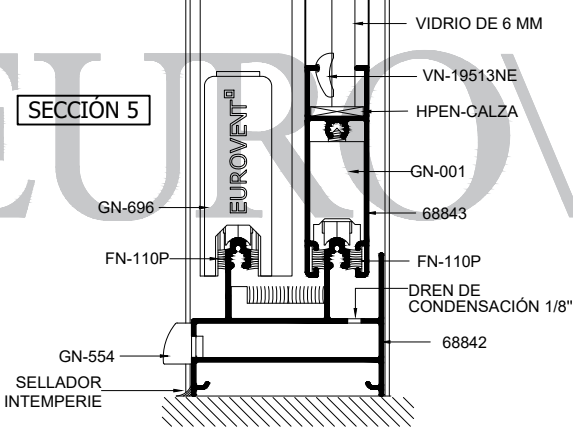
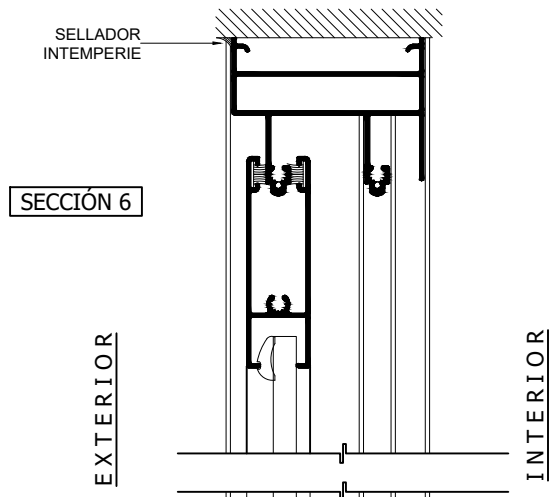
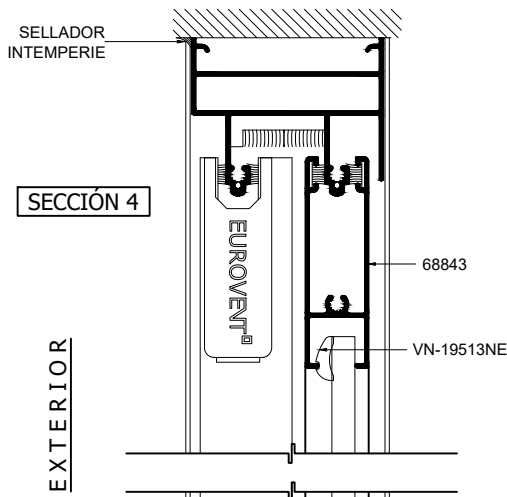



TROQUEL S-50  
GN-508A

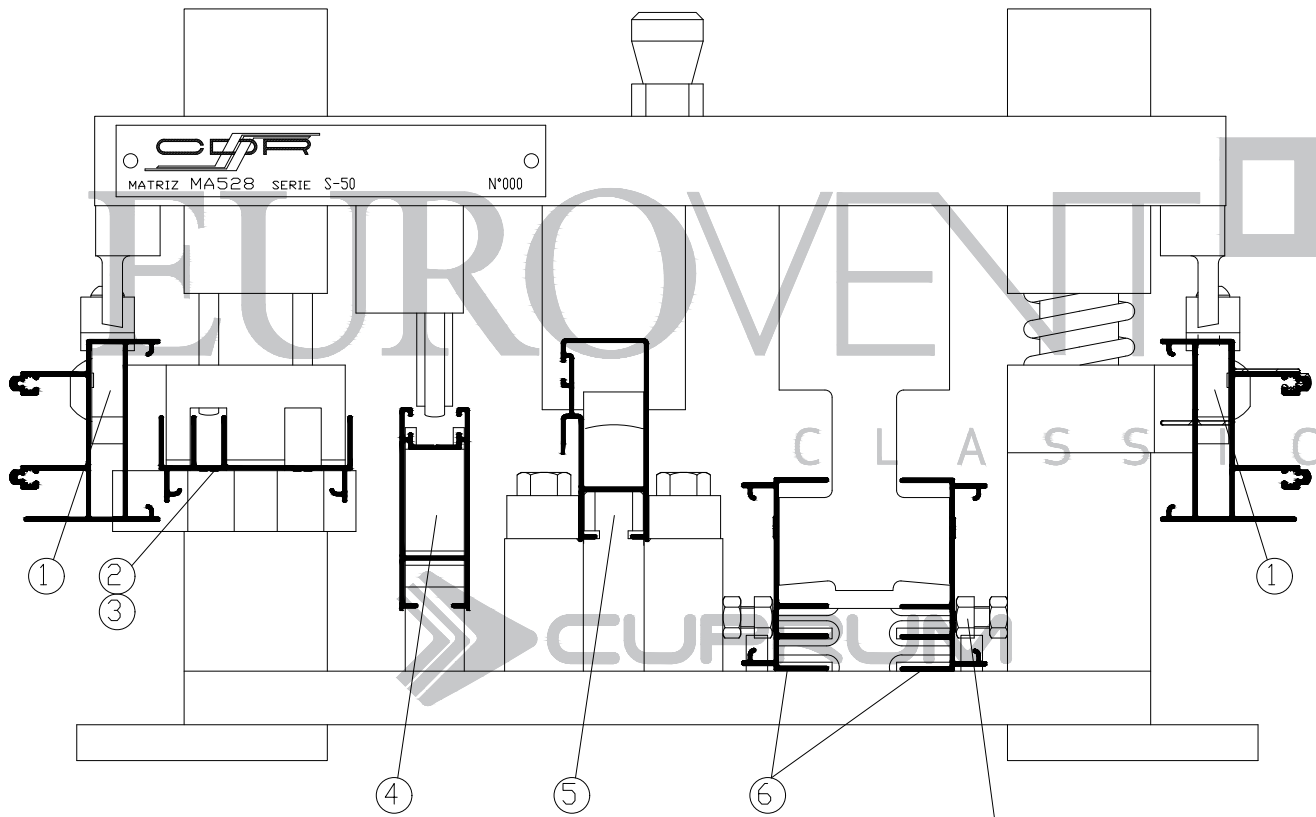

VISTA FRONTAL

Nota: Guías ajustables

DATOS DEL TROQUEL

MATRIZ ABIERTA: 180 mm.  
MATRIZ CERRADA: 160 mm.  
RECORRIDO: 20 mm.  
MUELLES DE RECUPERACION  
MATRIZ 4 COLUMNAS

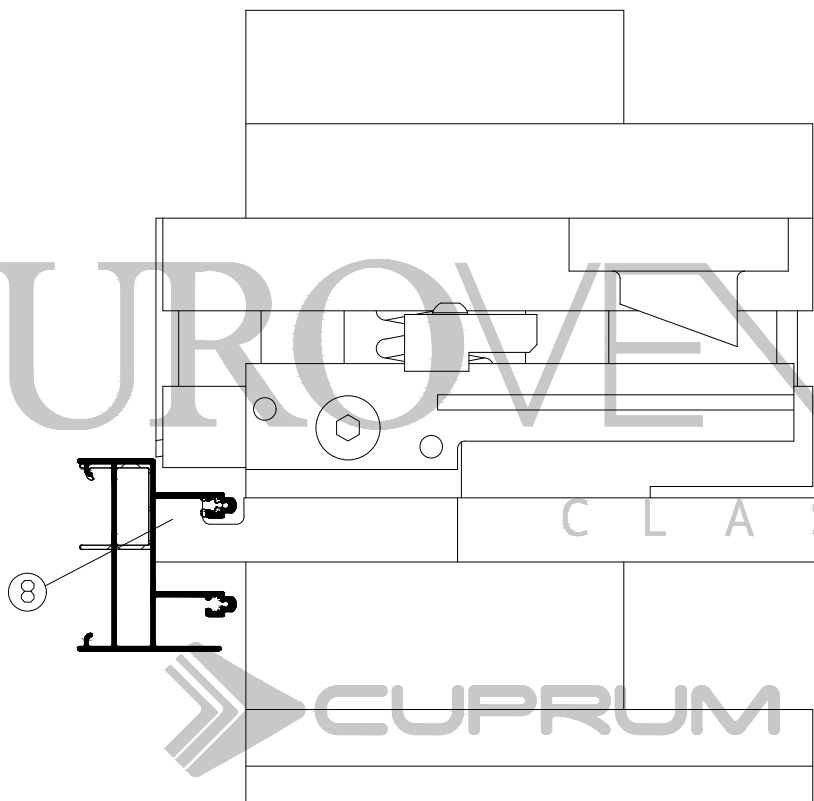

VISTA LATERAL

OPERACIÓN 1

DREN CAJA RIEL Y RIEL MOSQUITERO

**68842**  
RIEL

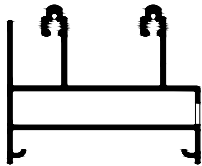

**68846**  
EXTENSION  
RIEL

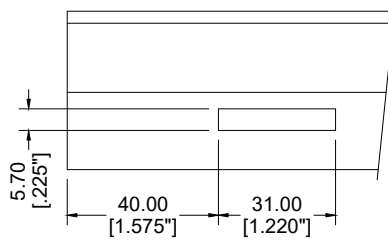
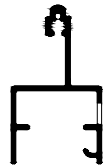

OPERACIÓN 2

PUNZONADO JAMBA

**68844**  
JAMBA

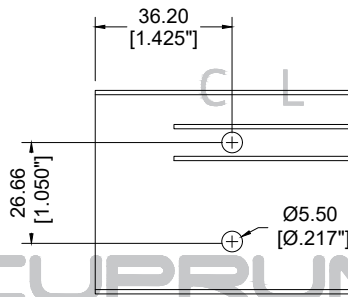
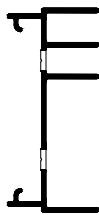

EUROVENT

CLASSIC

CUPRUM



CLASSIC

SERIE

S50

CORREDIZA



OPERACIÓN 3

PUNZONADO JAMBA MOSQUITERA

**68847**  
EXTENSIÓN  
JAMBA

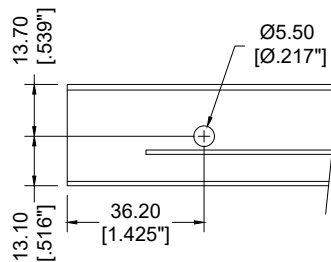
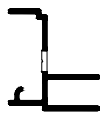

**OPERACIÓN 4**

PUNZONADO CERCO, TRASLAPE, CERCO DV  
Y TRASLAPE DV (REALIZAR ANTES OPERACIÓN N°5)

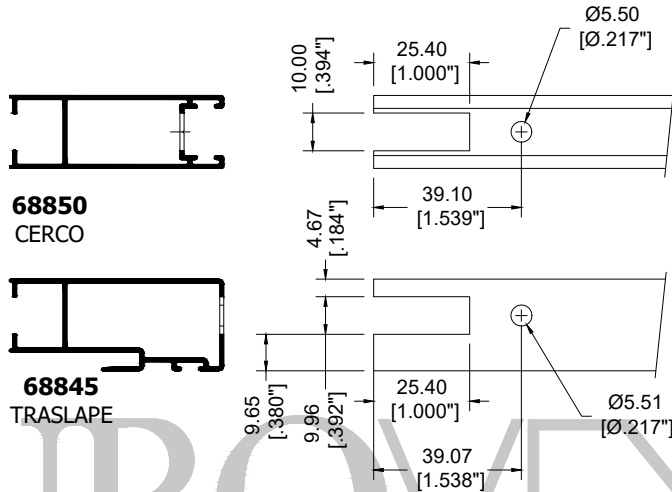

**OPERACIÓN 5**

CAJEADO CERCO, TRASLAPE, CERCO DV  
Y TRASLAPE DV

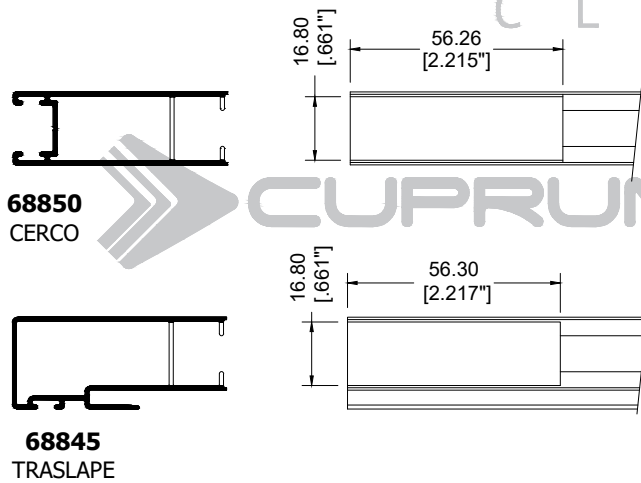

**OPERACIÓN 8**

DREN DE PISTA RIEL Y RIEL MOSQUITERA

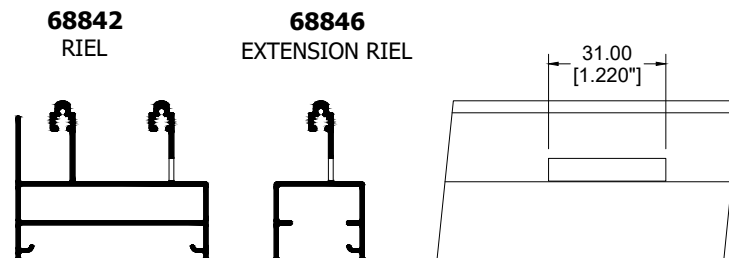

CLASSIC  
SERIE  
**S50**  
CORREDIZA

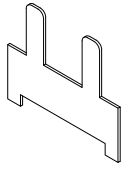

**EH-01**  
EMPAQUE DE  
HERMETICIDAD

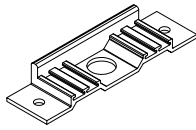

**GN-190**  
CORTAVIENTOS S-50

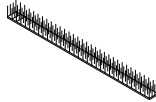

**FN-110P**  
FELPA CON PLÁSTICO

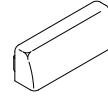

**GN-554**  
TAPA DREN



**GN-105**  
TAPÓN DESAGÜE

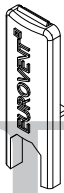

**GN-696**  
TAPA TRASLAPE



**VN-19513NE**  
EMPAQUE

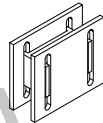

**GN-193**  
CALZA CANDADO S-50

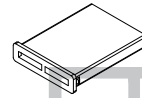

**GN-192**  
CONECTOR DREN S-50

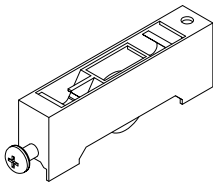

**GN-001**  
CARRETIILLA AJUSTABLE A BASE  
DE BALEROS 20 KG X PZA



**FN-552**  
BROCHE MINI 160MM  
(EMBUTIDO)

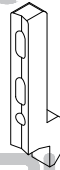

**FN-556C**  
CONTRA

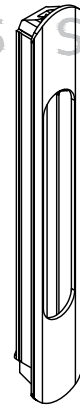

**UA800E4**  
UÑERO EMBUTIDO

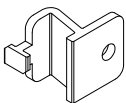

**GN-191**  
GRAPA MOSQUITERO

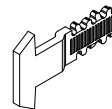

**FN-556**  
GANCHO/FLECHA

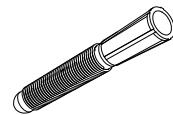

**TAQ1147**  
TAQUETE 1/4 D/PLASTICO

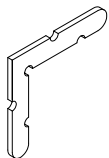

**ESC2039**  
ESCUADRA PLANA  
PARA MOSQUITERO

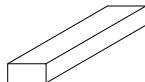

**HPEN-CALZA**  
CALZA DE 1/4" x 3/8" x 4"

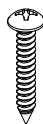

**PFNG-0811**  
TORNILLO PIJA #8 X 1"



**PFNG-0805**  
TORNILLO PIJA #8 X 1/2"

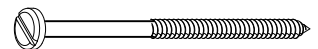

**TMNG-1026**  
TORN P/MADERA 10X76 GAL

CLASSIC  
SERIE  
**S50**  
CORREDIZA

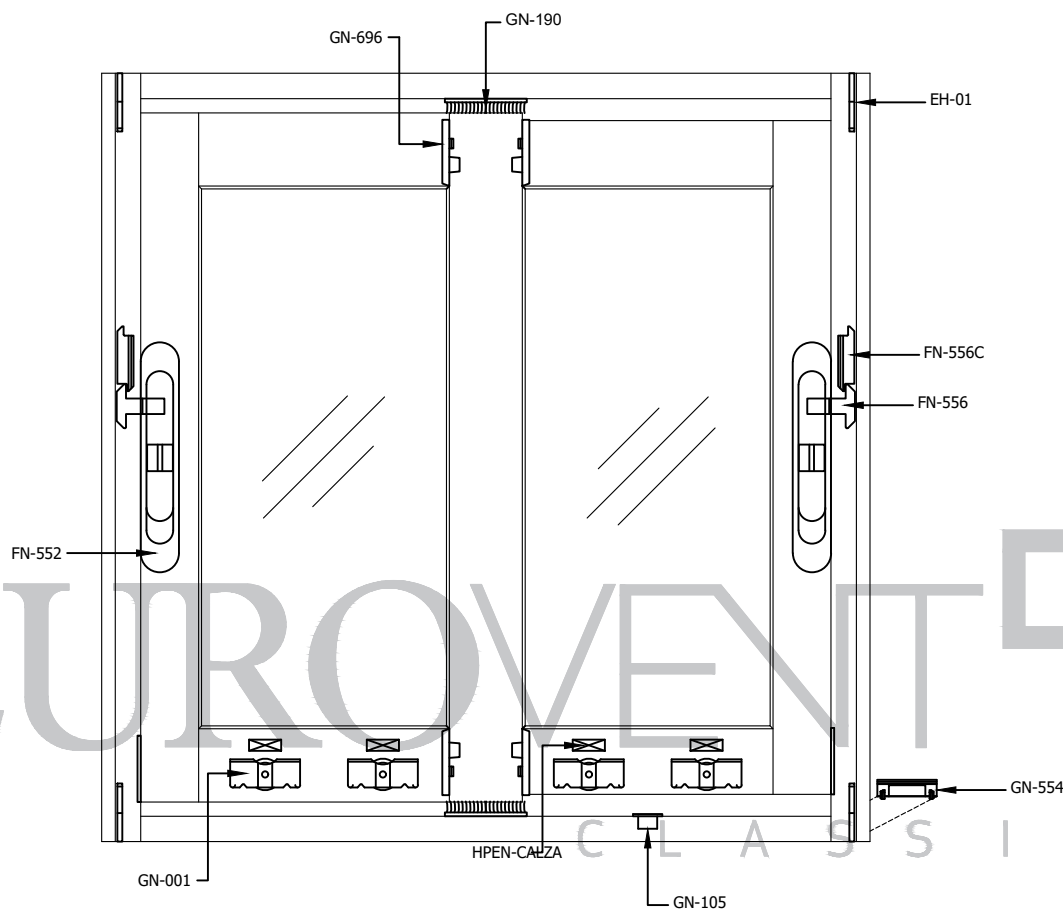

CLASSIC  
SERIE

S50



CORREDIZA

CUPRUM

**VENTANA CORREDIZA S50 XX**

CLAVE	DESCRIPCIÓN	PIEZAS
EH-01	EMPAQUE DE HERMETICIDAD	4
GN-001	CARRETILLA AJUSTABLE DE BALEROS	4
FN-552	BROCHE MINI 160MM (EMBUTIDO)	2
FN-556B	FLECHA	2
FN-556C	CONTRA	2
GN-190	CORTAVIENTO	2
GN-554	TAPA DREN CON VÁLVULA	2
GN-105	TAPÓN DESAGÜE	1
GN-696	TAPA TRASLAPE	4
VN-19513NE	VINIL CUÑA PARA CRISTAL	2L + 4H
FN-110P	FELPA CON PÁSTICO	4L + 6H
HPEN-CALZA	HPEN-CALZA DE SILICON	4
PFNG-0811	PIJA #8 X 1" CABEZA FIJADORA	17
PFNG-0805	PIJA #8 X 1/2" CABEZA PLANA	4

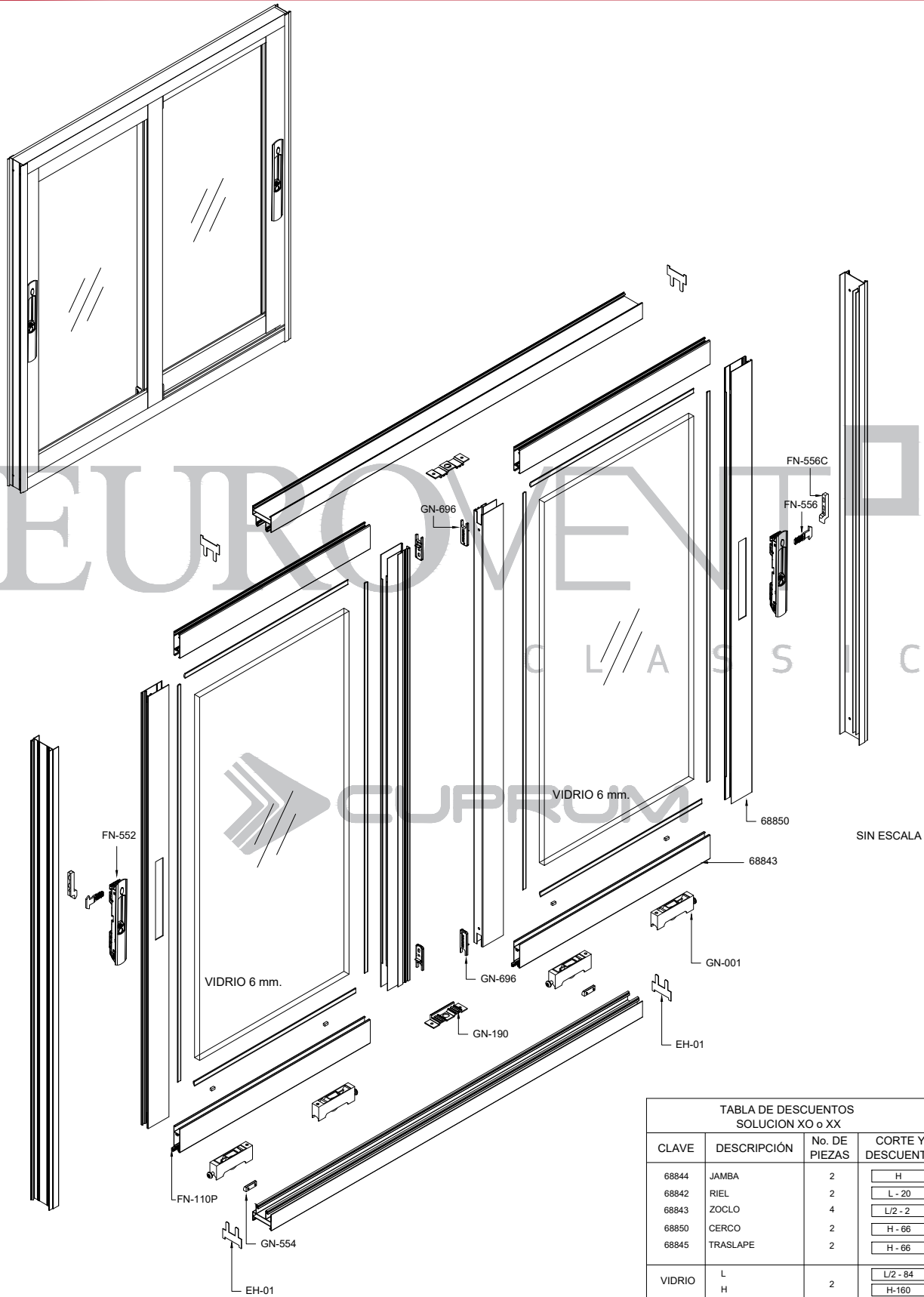

CLASSIC  
SERIE  
**S50**

CORREDIZA

SIN ESCALA

TABLA DE DESCUENTOS  
SOLUCION XO o XX

CLAVE	DESCRIPCIÓN	No. DE PIEZAS	CORTE Y DESCUENTO
68844	JAMBA	2	H
68842	RIEL	2	L - 20
68843	ZOCLO	4	L/2 - 2
68850	CERCO	2	H - 66
68845	TRASLAPE	2	H - 66
VIDRIO	L	2	L/2 - 84
	H		H - 160

L= ANCHO  
H= ALTO

DESCUENTOS EN MM.

CORREDIZA SERIE 50  
A UNA ALTURA DE 15 METROS

H cm DEFLEXIÓN MAX. L/175

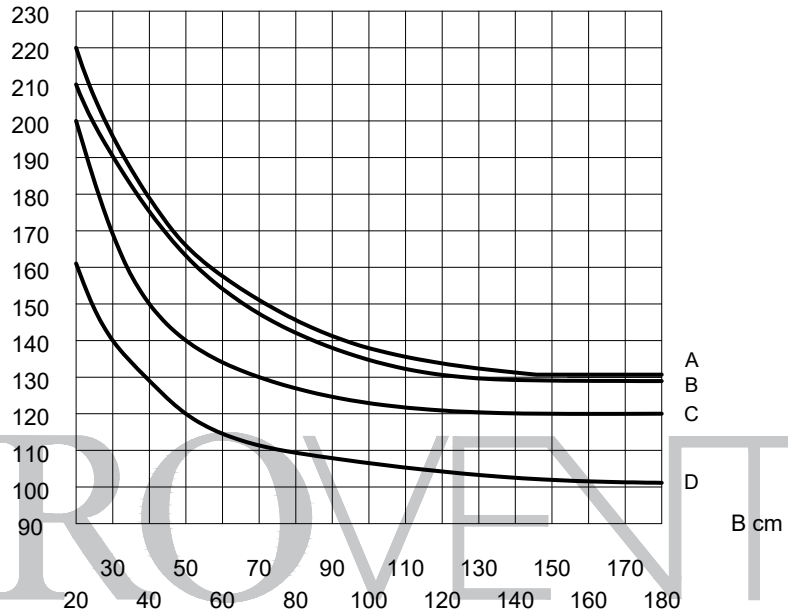

CLASSIC  
SERIE  
**S50**  
CORREDIZA

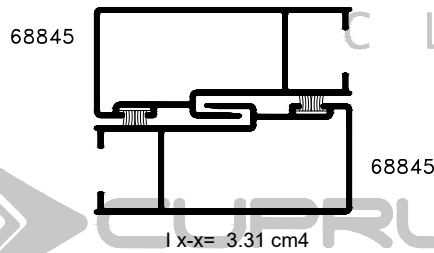

LOS LÍMITES DE FABRICACIÓN PARA LOS PERFILES, SERÁN LOS QUE SE ENCUENTREN DEBAJO DE LAS CURVAS GRAFICADAS.

ALEACIÓN: 6063  
TEMPLE: 5

Curvas	Presión del diseño	Velocidad de viento	Zona
A	45 Kg/m <sup>2</sup>	80 Km/h	Centro de grandes ciudades
B	50 Kg/m <sup>2</sup>	90 Km/h	Barrios Residenciales
C	65 Kg/m <sup>2</sup>	120 Km/h	Campo Abierto
D	110 Kg/m <sup>2</sup>	160 Km/h	Zona Costera

LOS LÍMITES DE UN CANCEL VAN EN FUNCIÓN DE LA COMBINACIÓN DE RESISTENCIA DEL PERFIL DE ALUMINIO, EL VIDRIO Y LOS ACCESORIOS QUE LO INTEGRAN.

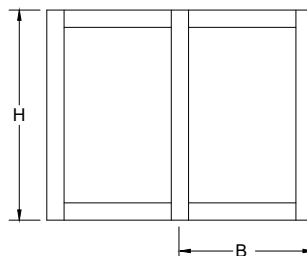

VERIFICAR QUE LA DEFLEXIÓN DEL PERFIL SEA COMPATIBLE CON EL VIDRIO UTILIZADO.



## PARÁMETROS MÍNIMOS Y MÁXIMOS DE FABRICACIÓN.

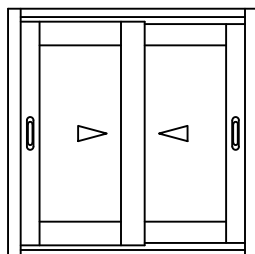

VC-50  
MÍNIMO 0.40 x 0.40 HOJA  
MÁXIMO 0.80 x 1.80 HOJA

EUROVENT<sup>®</sup>

CLASSIC  
SERIE

S50

CORREDIZA



ALUMINIO					
CLAVE	DESCRIPCIÓN	PIEZAS X ATADO	LARGO STD. MTS.	PERÍMETRO ANOD. CM.	PERÍMETRO PUL. CM.
68844	JAMBA	8	6.10	26.80	18.56
68847	EXTENSIÓN JAMBA	20	6.10	15.17	9.32
69356	ADAPTADOR DOBLE VIDRIO	20	6.10	12.97	4.23
68842	RIEL	6	6.10	33.87	17.27
68846	EXTENSIÓN RIEL	8	6.10	21.10	10.64
69368	ADAPTADOR MOSQUITERO	20	6.10	12.01	4.10
68845	TRASLAPE	8	6.10	35.58	16.10
68850	CERCO	8	6.10	33.18	17.01
68843	ZOCLO	10	6.10	30.60	12.60
50701	ADAPTADOR OXXO	30	6.10	9.17	4.20



Este manual esta protegido bajo varias patentes y diseños en tramite.  
Prohibida su reproducción total o parcial.