

PUERTA COMERCIAL SERIE 50

# EUROVENT

CLASSIC



PUERTA COMERCIAL SERIE 50  
PUERTA RESIDENCIAL SERIE 50

UNA ACCIÓN

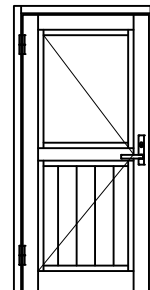
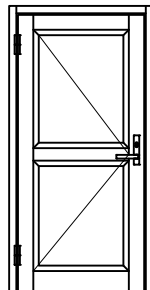
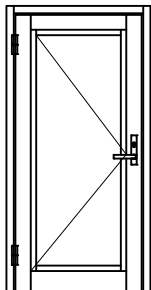

CLASSIC  
SERIE  
S50  
BATIENTE PUERTA

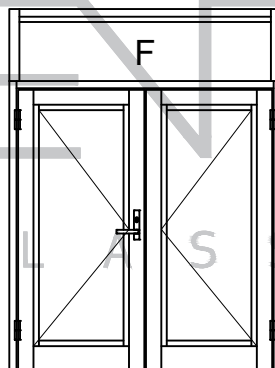
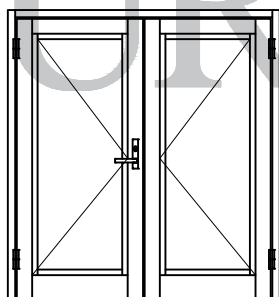

DOBLE ACCIÓN

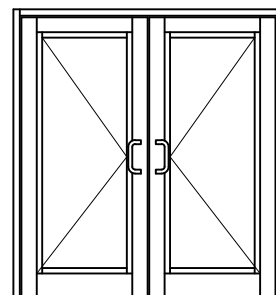
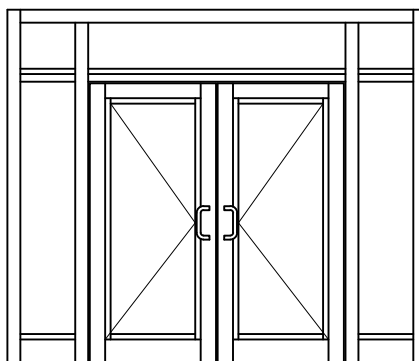
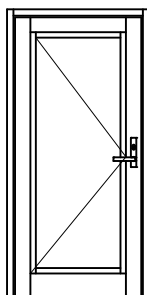

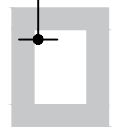
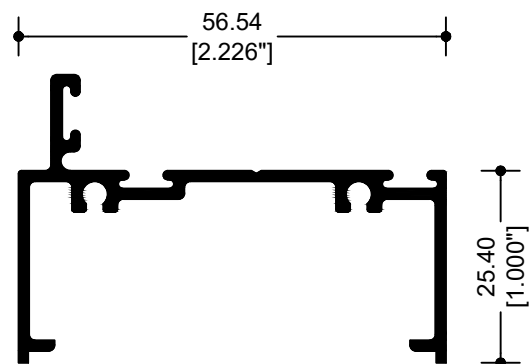
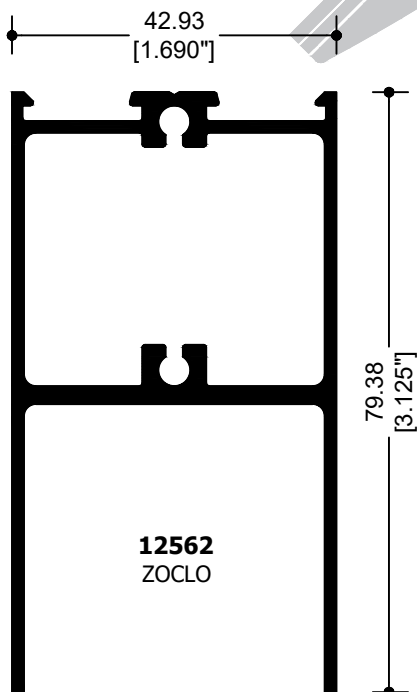
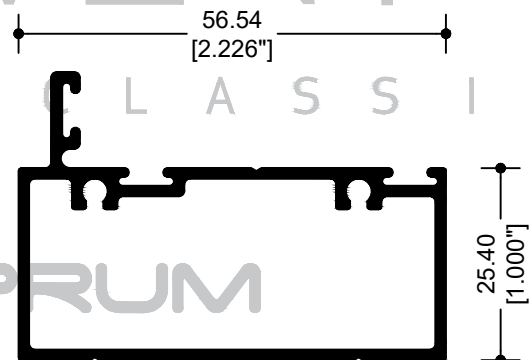
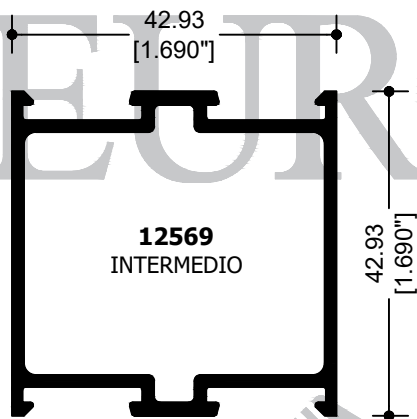
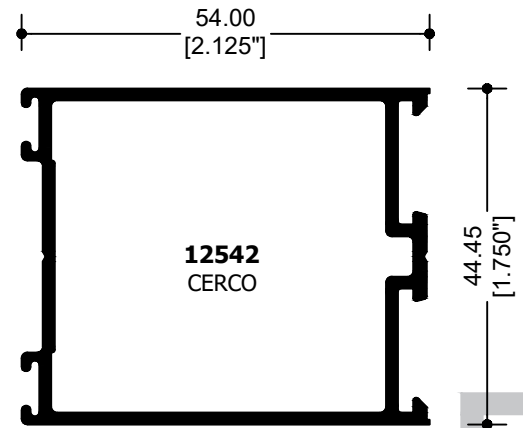
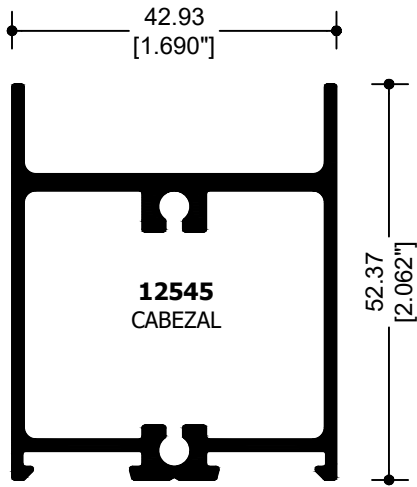

CLASSIC

SERIE

S50



BATIENTE PUERTA

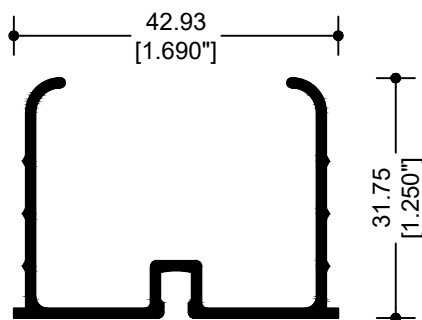

**12566**  
SELLO DE HERMETICIDAD

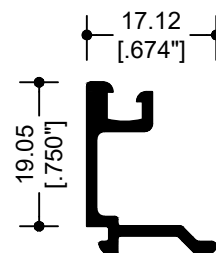

**12603**  
JUNQUILLO DOBLE VIDRIO

CLASSIC  
SERIE

S50

BATIENTE PUERTA

EUROVENT<sup>®</sup>  
CLASSIC

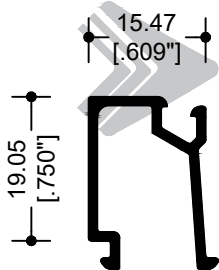

**12543**  
JUNQUILLO

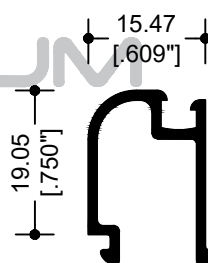

**12576**  
JUNQUILLO COLONIAL

PUERTA UNA ACCIÓN,  
DOBLE VIDRIO

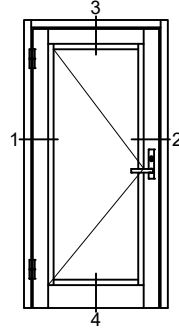

ELEVACION TIPO

SIN ESCALA

EUROVENT<sup>®</sup>

CLASSIC  
SERIE

EXTERIOR

C L A S S I C

BATIENTE PUERTA

S50

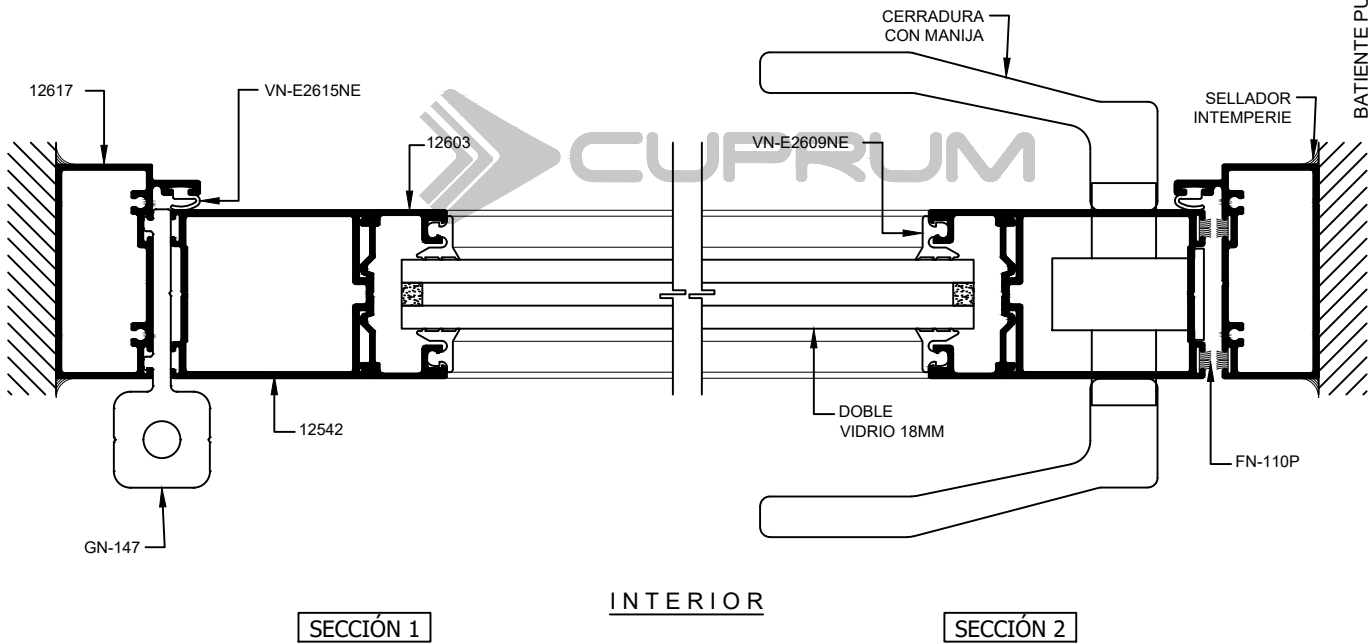

JUNQUILLO PARA DOBLE VIDRIO DE 18mm.

CLASSIC  
SERIE  
S50  
BATIENTE PUERTA

EUROVENT  
CLASSIC

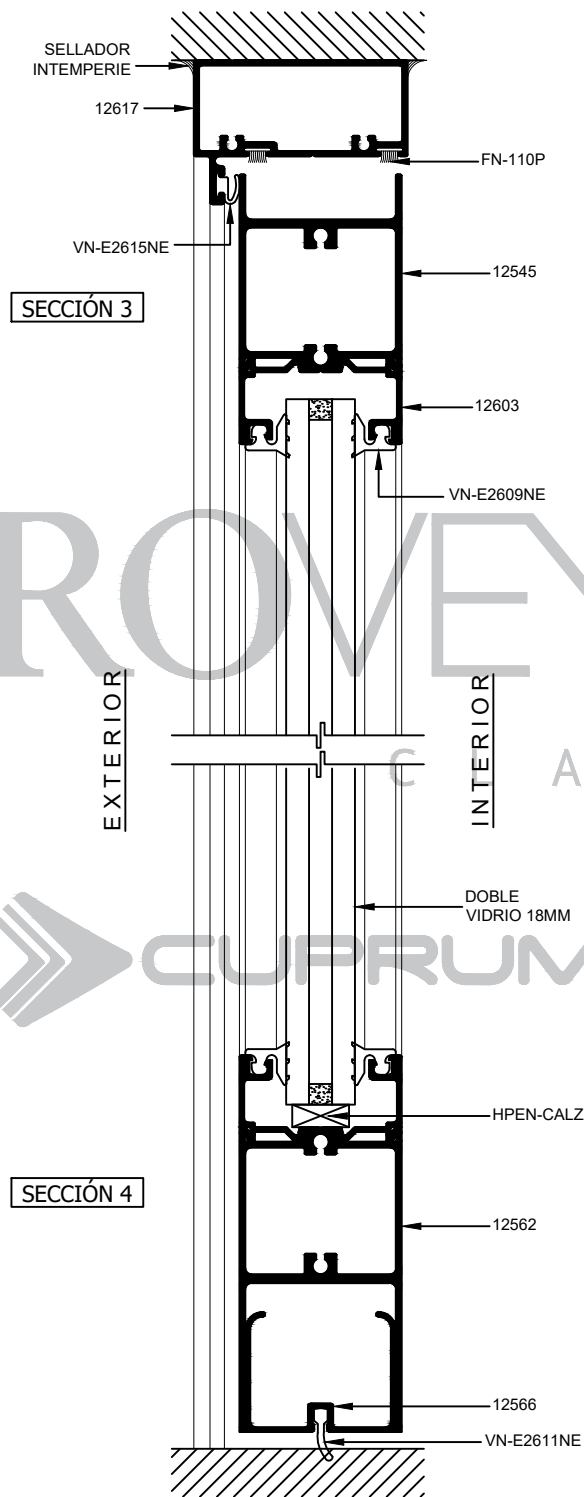

JUNQUILLO PARA DOBLE VIDRIO DE 18mm.

**PUERTA UNA ACCIÓN, VIDRIO SENCILLO**

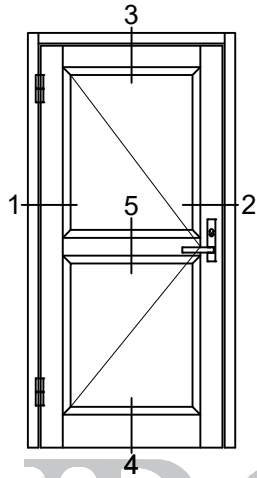

ELEVACIONES TIPO

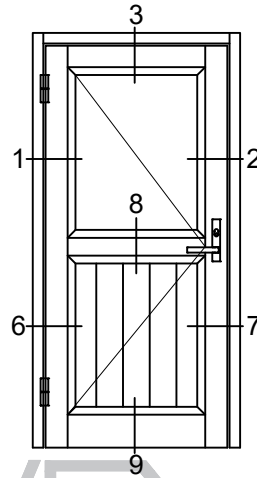

SIN ESCALA

EUROVENT

C L A S S I C



CLASSIC

SERIE

S50



BATIENTE PUERTA

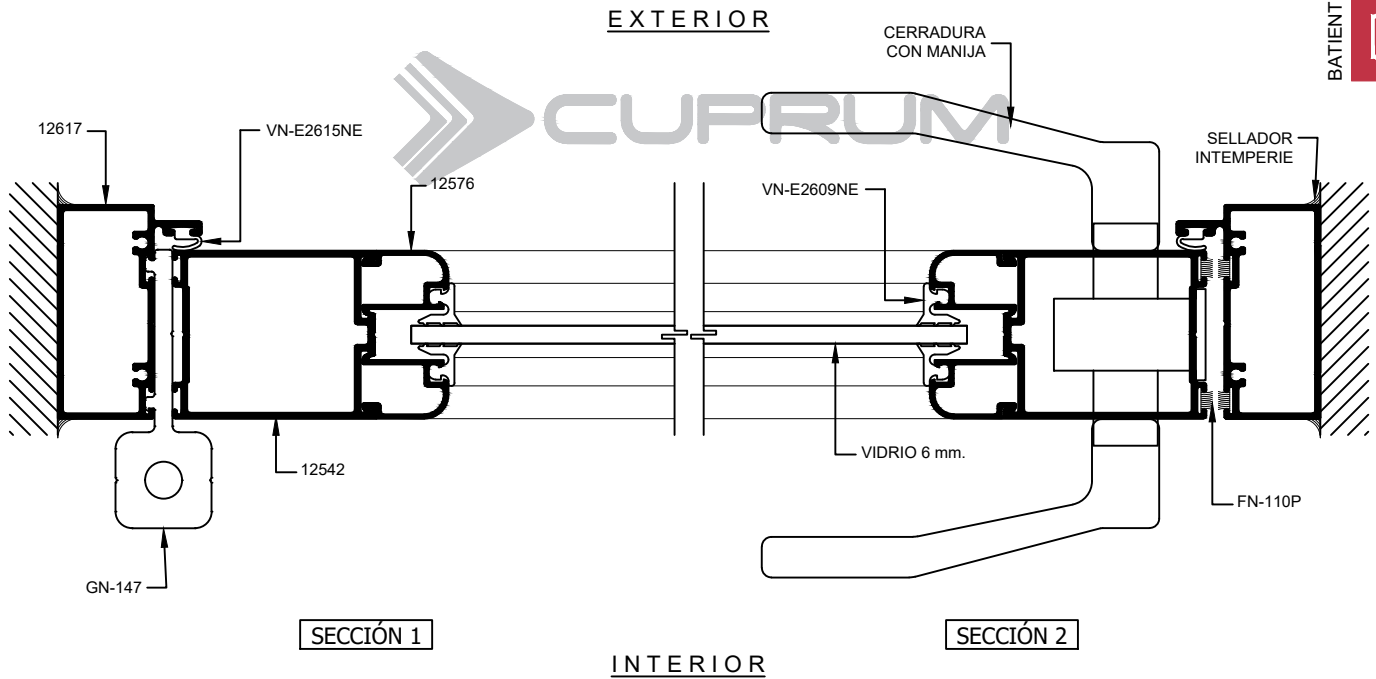



CLASSIC  
SERIE  
**S50**  
BATIENTE PUERTA

EUROVENT<sup>®</sup>  
CLASSIC

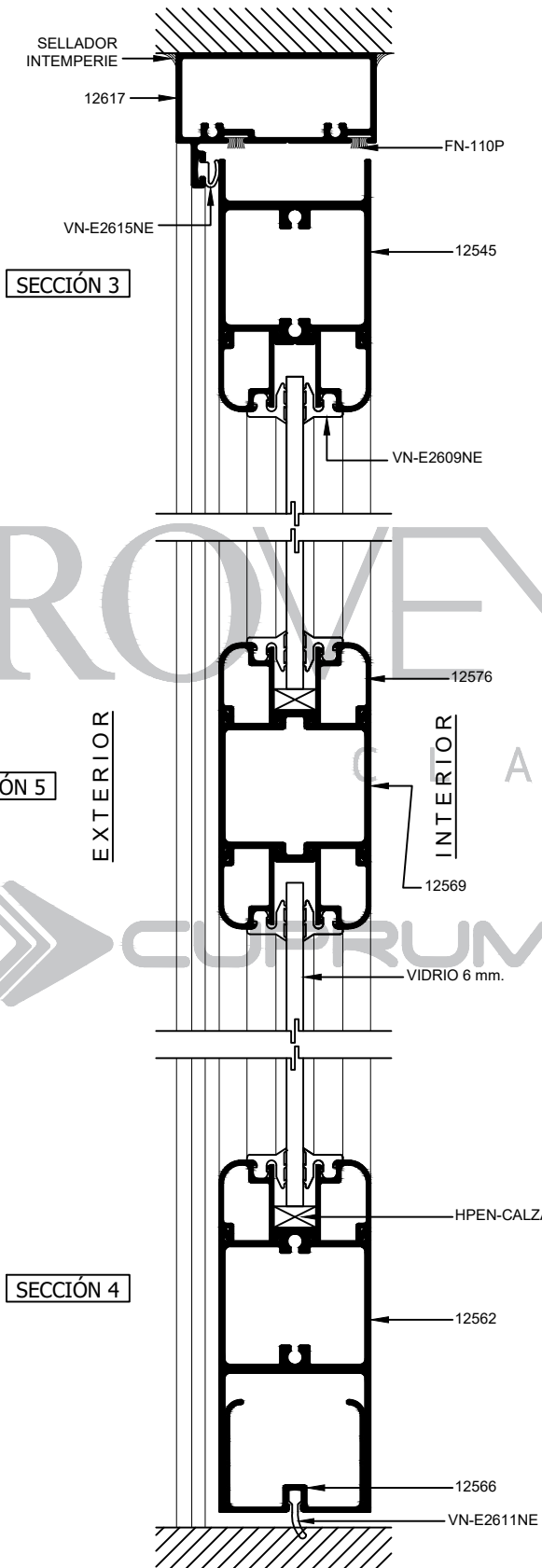

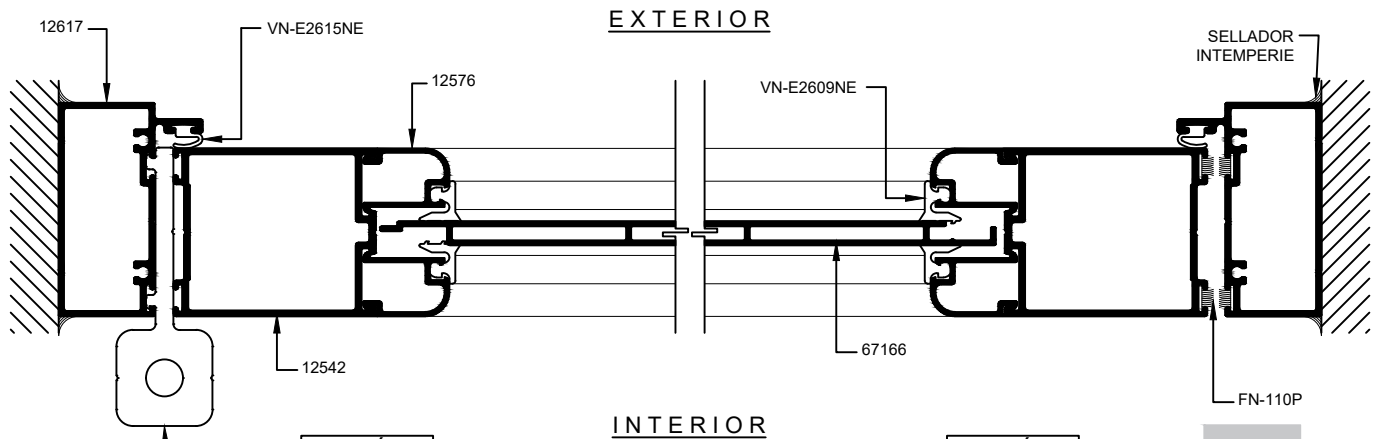

EUROVENT

CLASSIC  
SERIE  
S50  
BATIENTE PUERTA

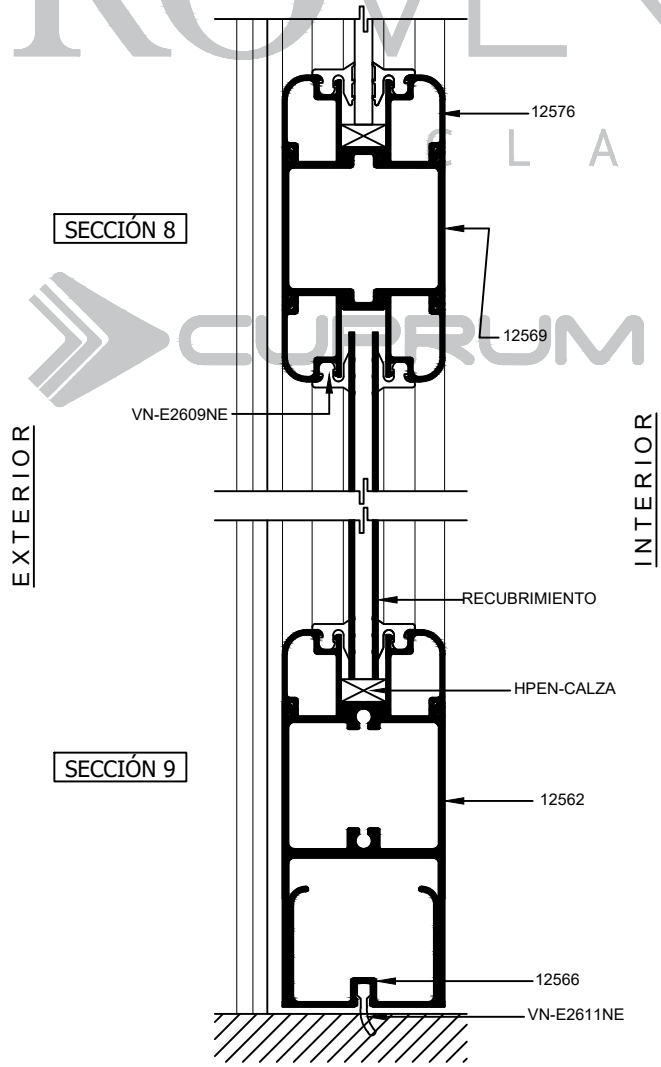

PUERTA UNA ACCIÓN,  
VIDRIO SENCILLO

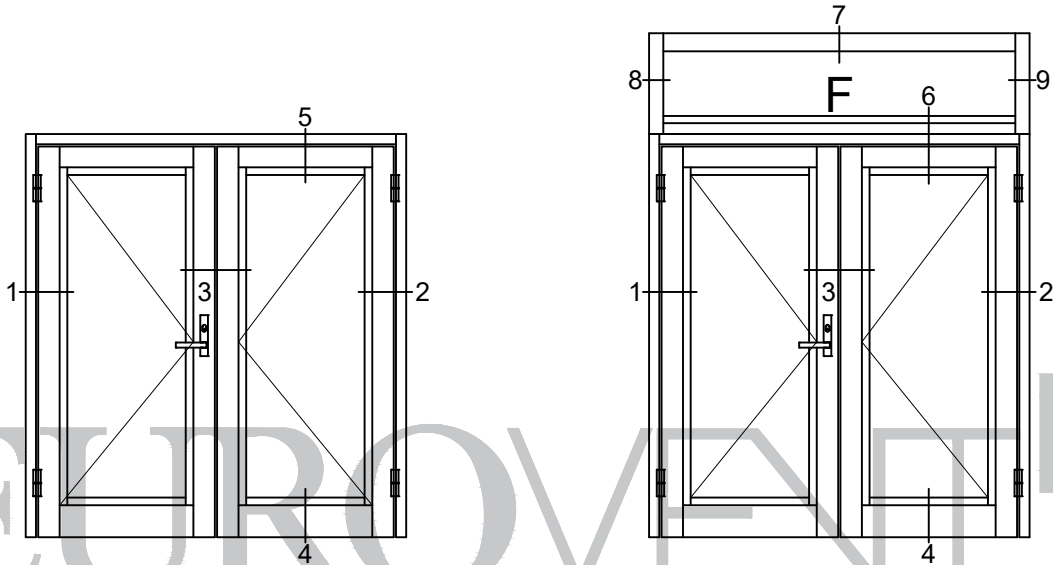

CLASSIC  
SERIE

S50



BATIENTE PUERTA

SIN ESCALA

C L A S S I C

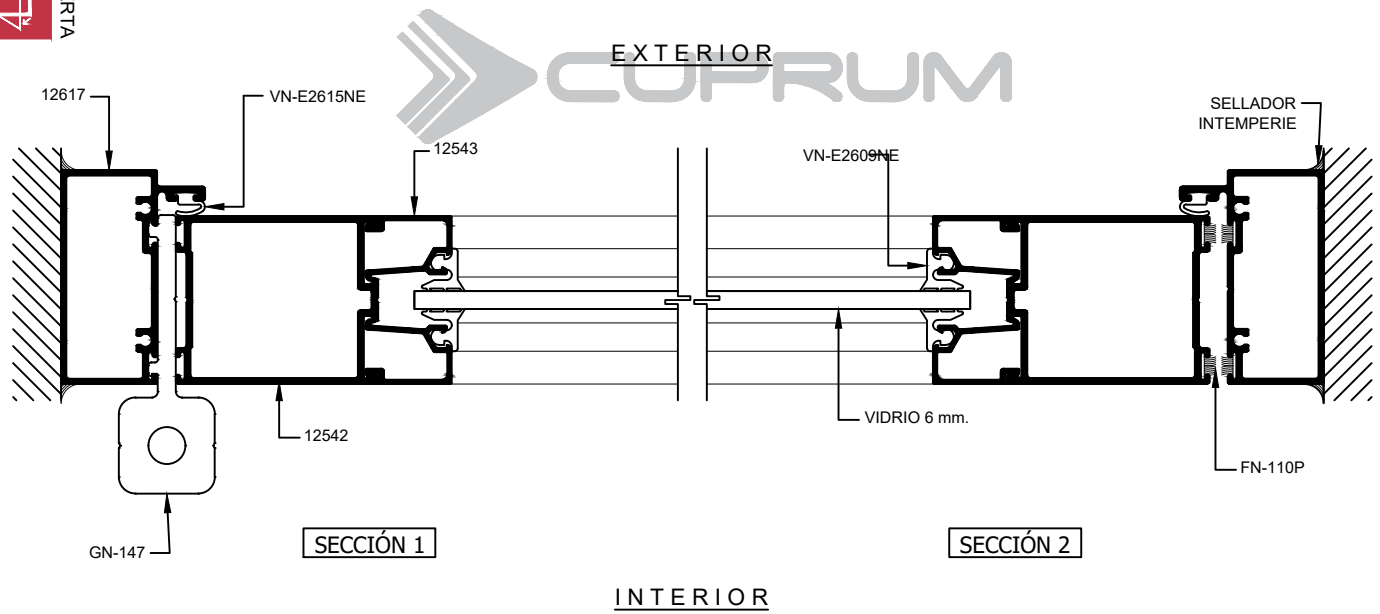

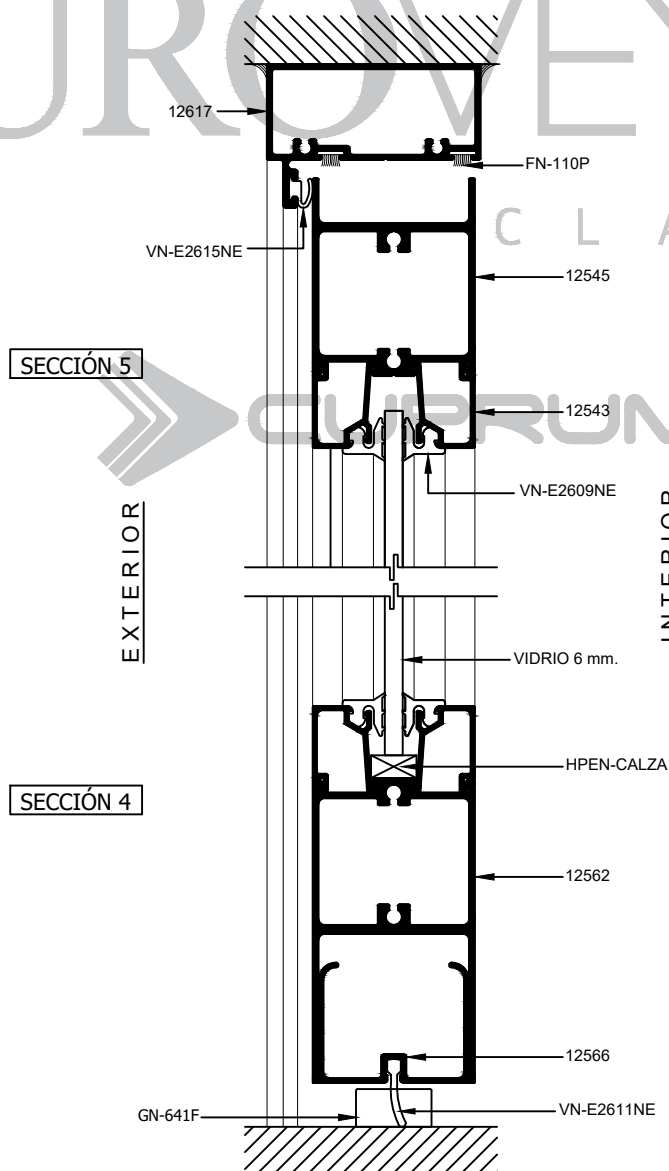
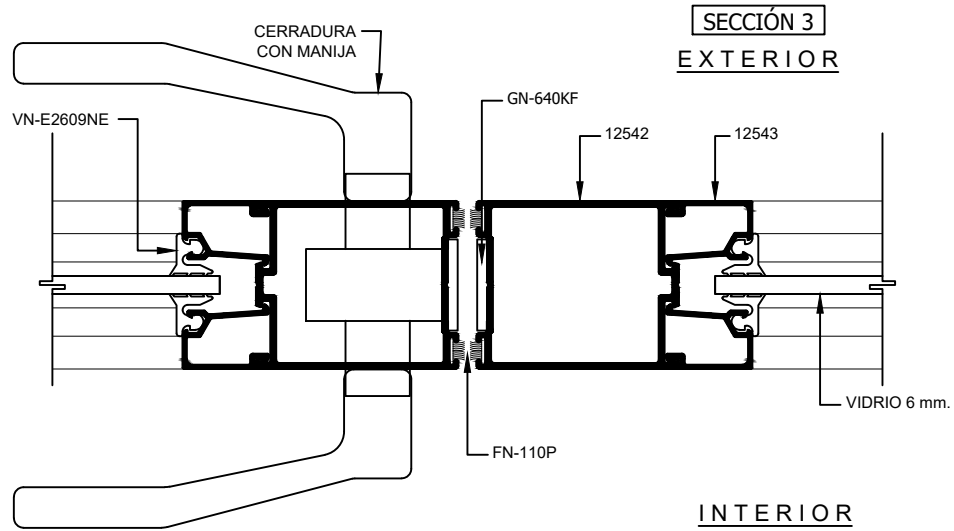

EUROVENT

CLASSIC

SERIE

S50

BATIENTE PUERTA

CUPRUM

CLASSIC  
SERIE  
**S50**  
BATIENTE PUERTA

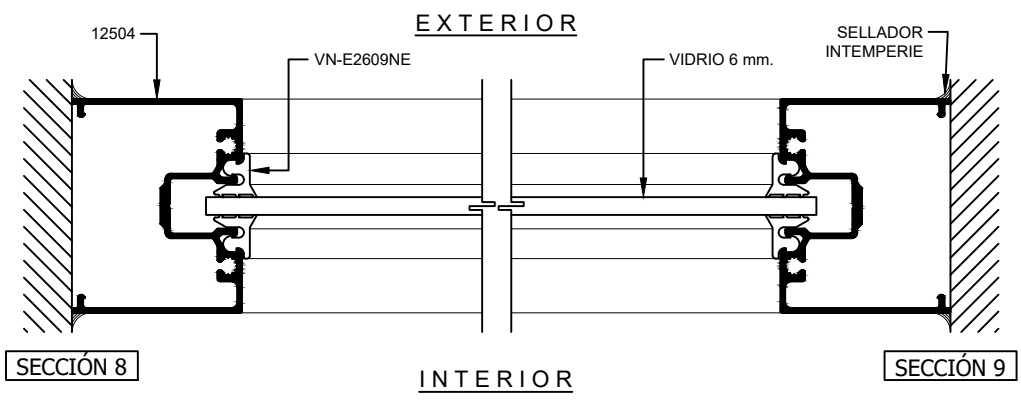
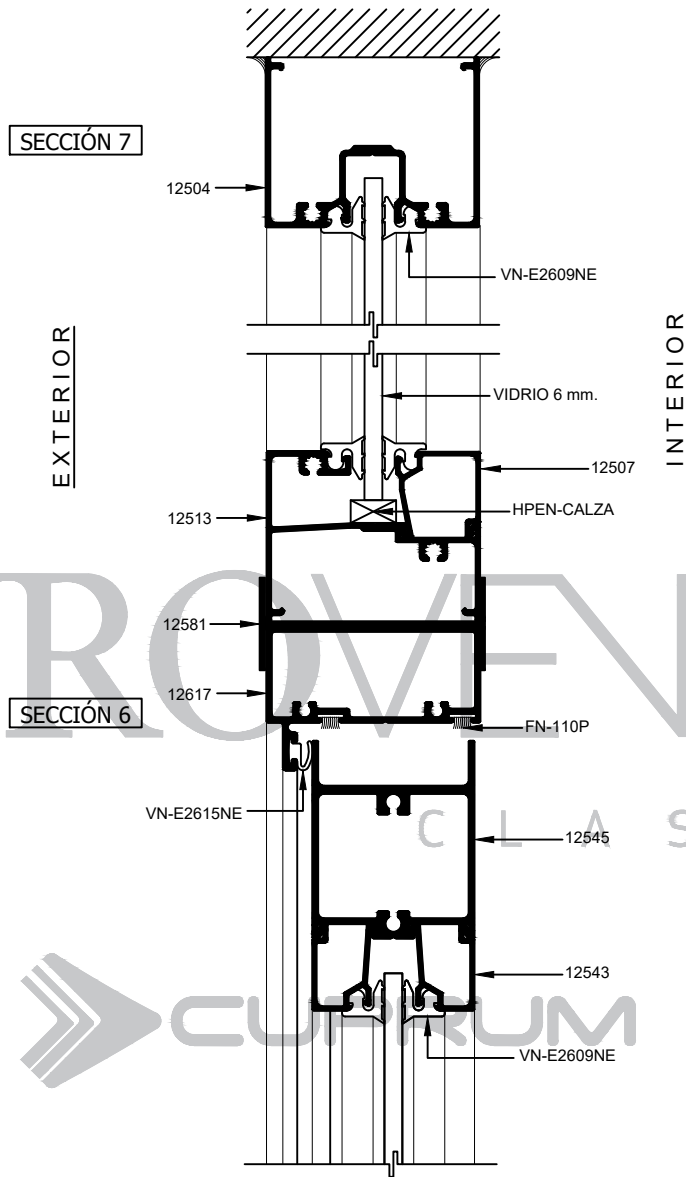

**PUERTA DOBLE ACCIÓN,  
VIDRIO SENCILLO**

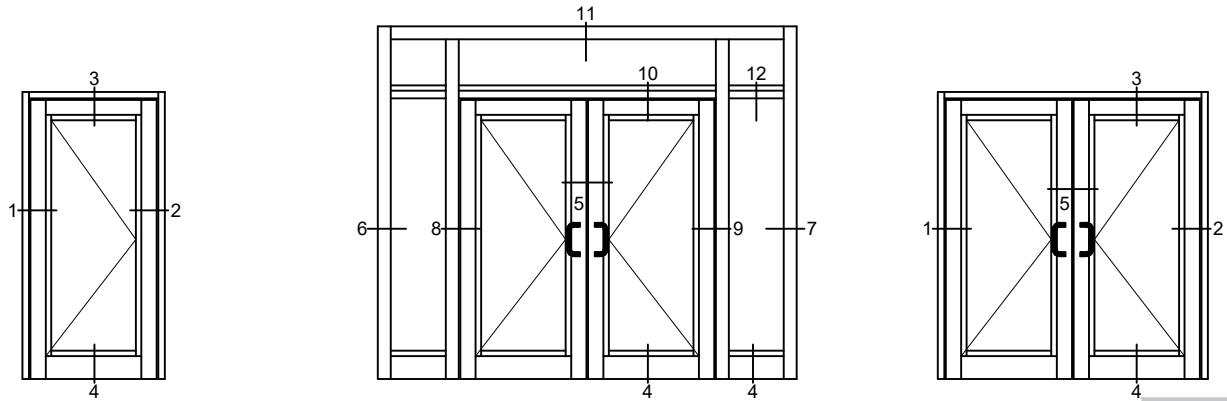

EUROVENT

SIN ESCALA



CLASSIC

SERIE

C L A S S I C

BATIENTE PUERTA

S50



EXTERIOR

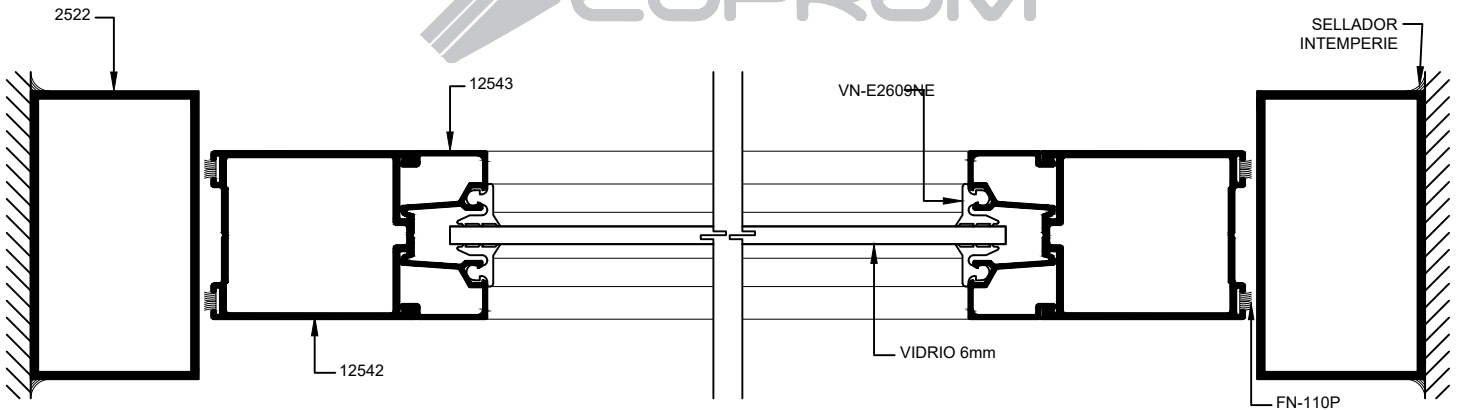

INTERIOR

SECCIÓN 1

SECCIÓN 2

CLASSIC  
SERIE  
**S50**  
BATIENTE PUERTA

EUROVENT  
CLASSIC

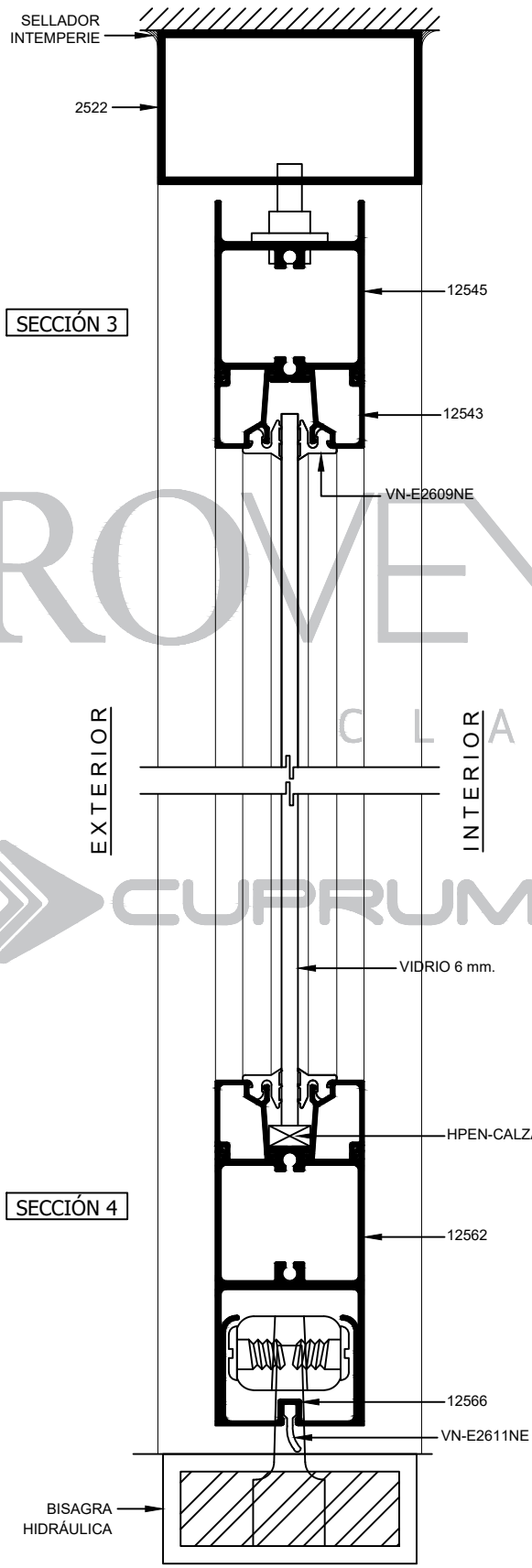

EXTERIOR

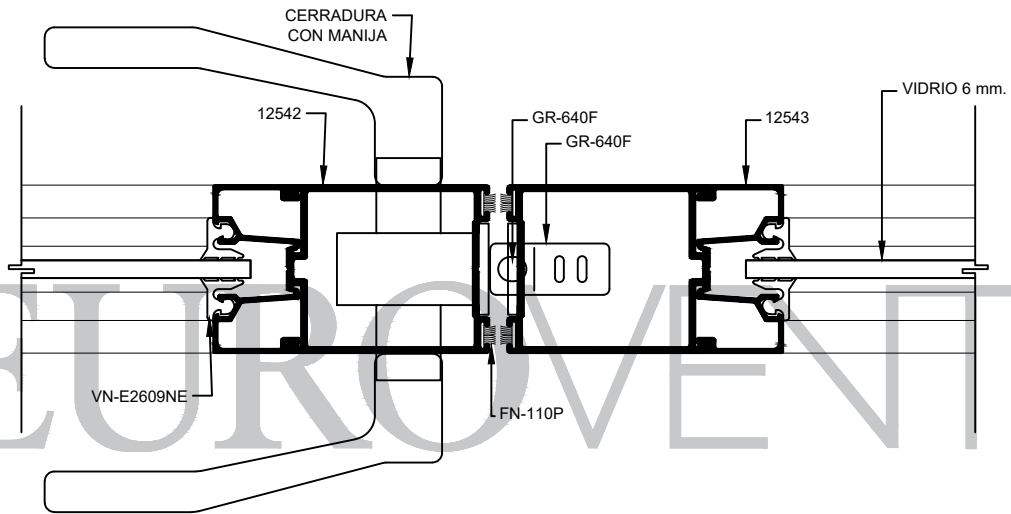

CLASSIC  
SERIE

C L A S S I C

INTERIOR

SECCIÓN 5



BATIENTE PUERTA

S50



EXTERIOR

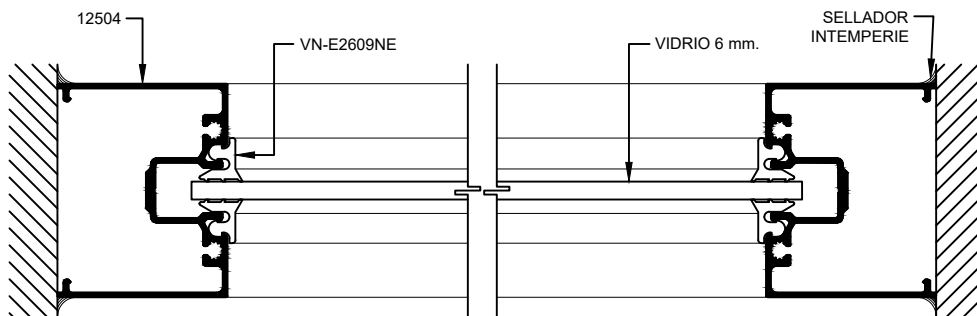

SECCIÓN 6

INTERIOR

SECCIÓN 7



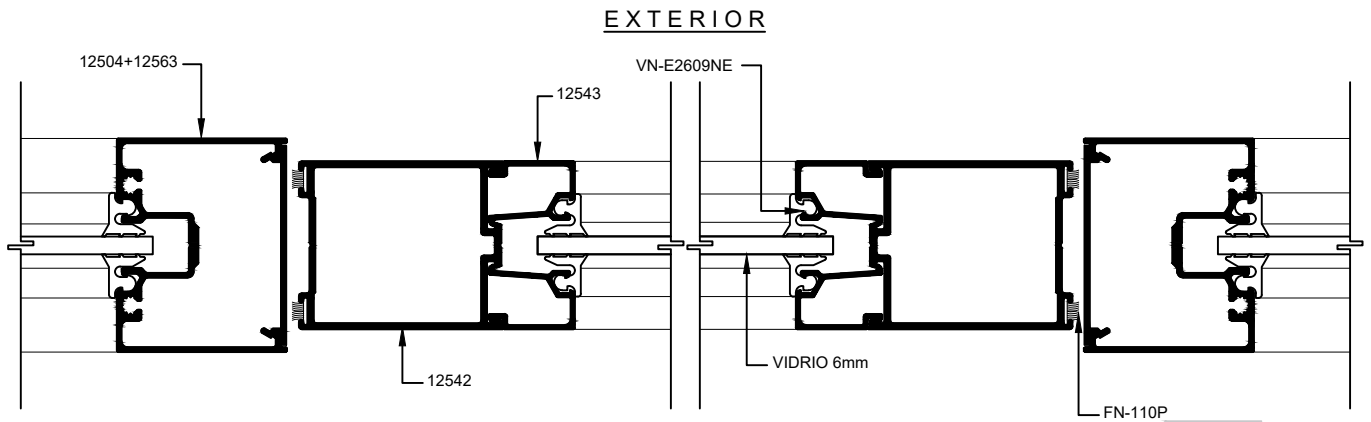

CLASSIC

SERIE

S50

BATIENTE PUERTA



EUROVENT<sup>®</sup>  
CLASSIC

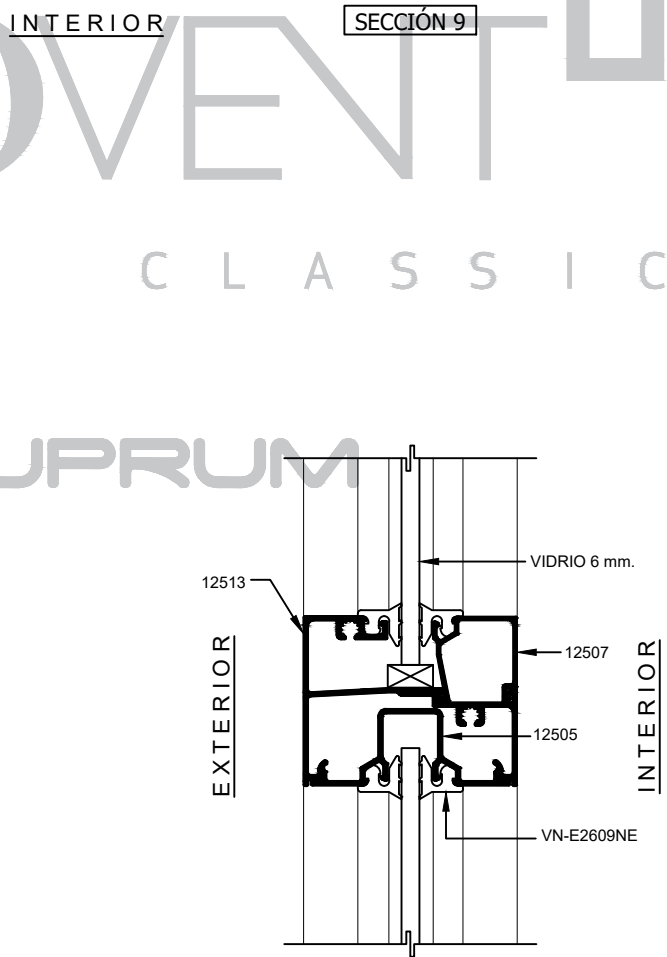
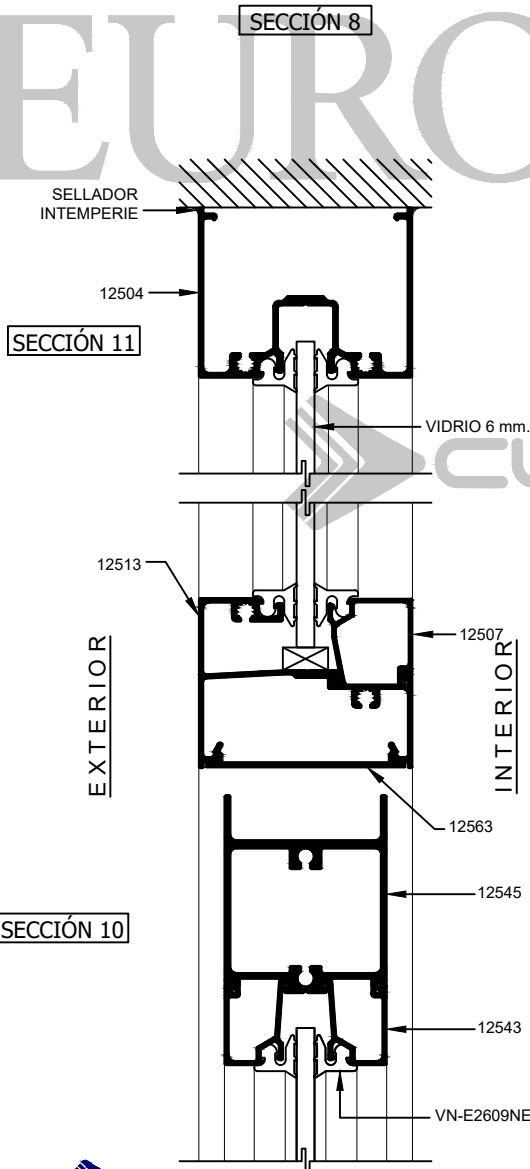

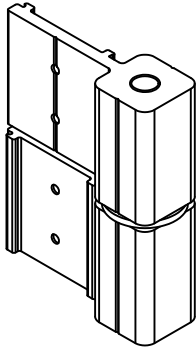

**GN-147**  
 BISAGRA LIBRO  
 CAPACIDAD DE CARGA:  
 CON 2 BISAGRAS 80 KG.  
 CON 3 BISAGRAS 100 KG.  
 (CONSIDERANDO LAS  
 DIMENSIONES DE 1000 MM. x  
 2000 MM.)

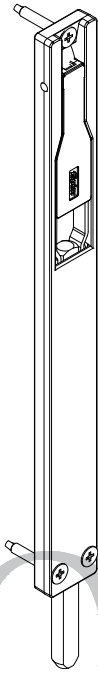

**GN-640KF**  
 PASADOR

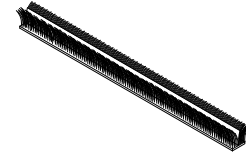

**FN-110P**  
 FELPA CON PLÁSTICO

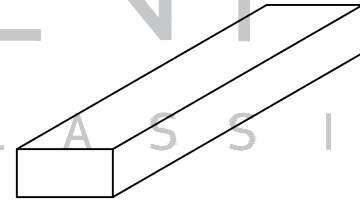

**HPEN-CALZA**  
 CALZA DE 1/4" x 3/8" x 4"



**VN-E2615NE**  
 EMPAQUE BATIENTE



**VN-E2609NE**  
 EMPAQUE BATIENTE



CLASSIC

SERIE

**S50**



BATIENTE PUERTA

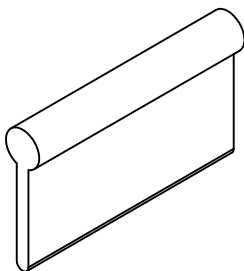

**VN-E2611NE**  
 VINIL ALETA



**EURO-GN102**  
 TAPÓN CUBRE PIJA

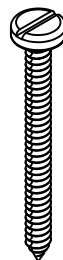

**PFNG-0805**  
 #8x1½"

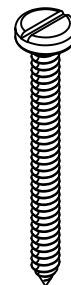

**PENG-1017**  
 #10x1½"



**T2137120**  
 TENSOR 3/8"



CLASSIC  
SERIE  
**S50**  
BATIENTE PUERTA



TABLA DE DESCUENTOS PUERTA BATIENTE			
CLAVE	DESCRIPCIÓN	No. DE PIEZAS	CORTE Y DESCUENTO
12617	BATIENTE	1	L-51
12617	BATIENTE	2	H
12542	CERCO	2	H-44
12562	ZOCLO	1	L-171
12545	CABEZAL	1	L-171
12569	INTERMEDIO	1	L-171
12543	JUNQUILLO	8	L-209
12543	JUNQUILLO	8	H/2-110
12566	S HERMETICIDAD	1	L-73
VIDRIO	L	2	L-180
	H		H/2-120

L= ANCHO DE VENTANA  
H= ALTO DE VENTANA

DESCUENTOS EN MM.

DEFLEXIÓN MAX. L/175

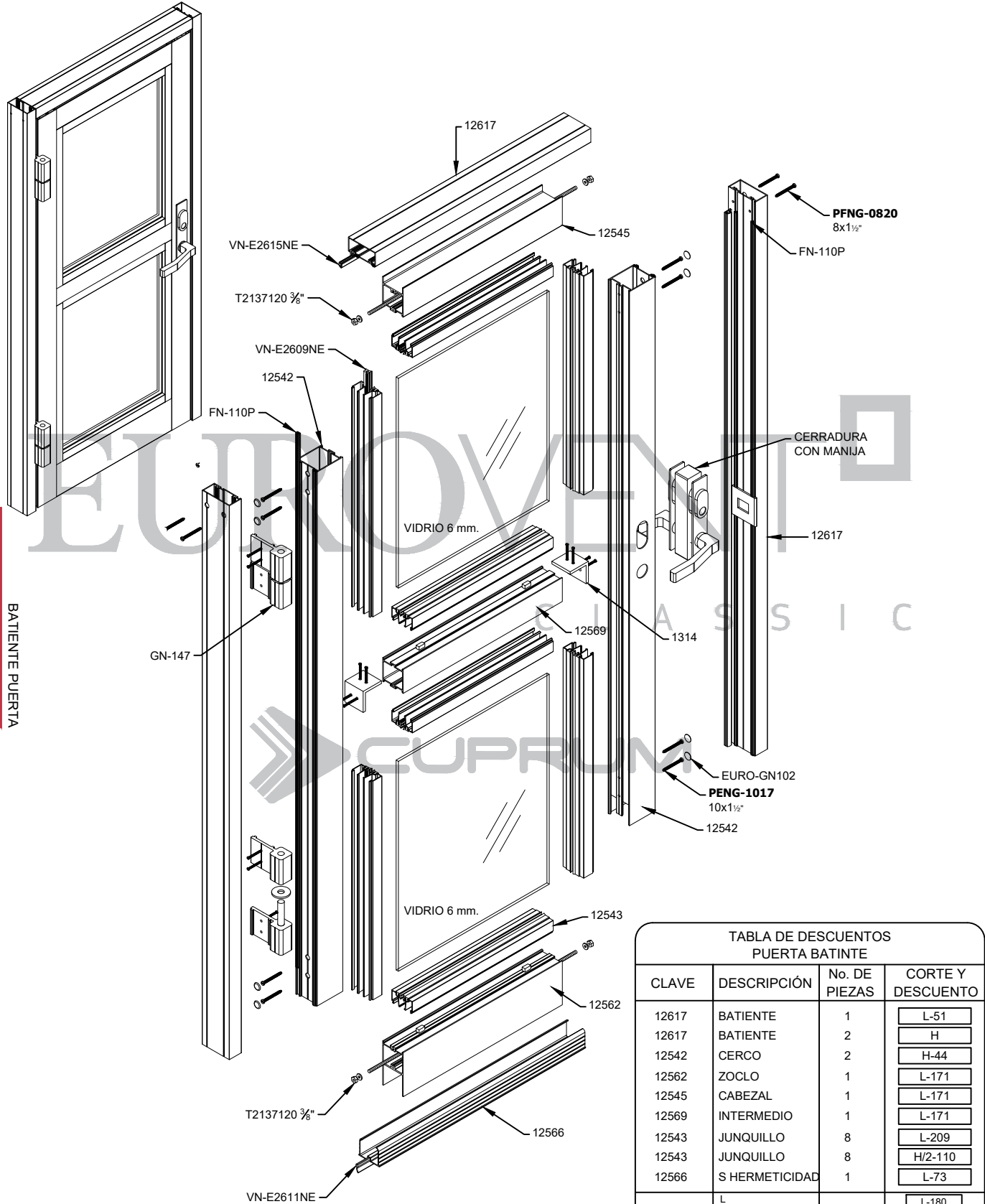
LOS LÍMITES DE FABRICACIÓN PARA LOS PERFILES, SERÁN LOS QUE SE ENCUENTREN DEBAJO DE LAS CURVAS GRAFICADAS.

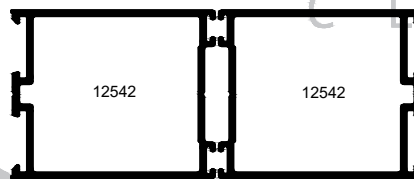
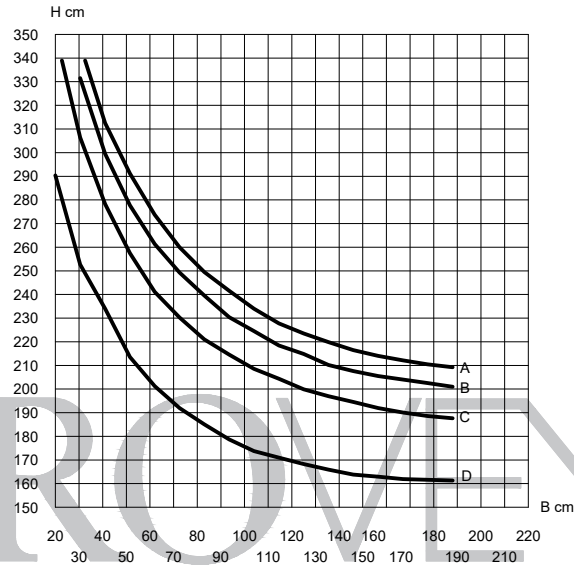

ALEACIÓN: 6063  
TEMPLE: 5

I x-x= 20,12 cm<sup>4</sup>

CLASSIC  
SERIE  
S50  
BATIENTE PUERTA

Valores de presión por velocidad de viento

Curvas	Presión del diseño	Velocidad de viento	Zona
A	45 Kg/m <sup>2</sup>	80 Km/h	Centro de grandes ciudades
B	50 Kg/m <sup>2</sup>	90 Km/h	Barrios Residenciales
C	65 Kg/m <sup>2</sup>	120 Km/h	Campo Abierto
D	124 Kg/m <sup>2</sup>	160 Km/h	Zona Costera

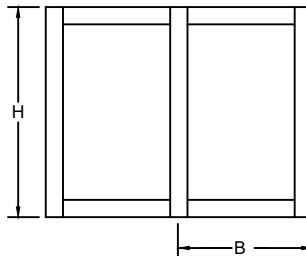

LOS LÍMITES DE UN CANCEL VAN EN FUNCIÓN DE LA COMBINACIÓN DE RESISTENCIA DEL PERFIL DE ALUMINIO, EL VIDRIO Y LOS ACCESORIOS QUE LO INTEGRAN.

VERIFICAR QUE LA DEFLEXIÓN DEL PERFIL SEA COMPATIBLE CON EL VIDRIO UTILIZADO.

PARÁMETROS MÍNIMOS Y MÁXIMOS DE FABRICACIÓN.

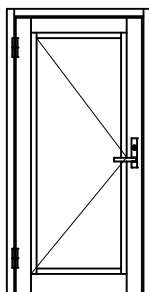

PBC-50  
MÍNIMO 0.60 x 1.80  
MÁXIMO 1.00 x 2.40



CLASSIC

SERIE

S50



BATIENTE PUERTA

**ALUMINIO**

CLAVE	DESCRIPCIÓN	PIEZAS X ATADO	LARGO STD. MTS.	PERÍMETRO ANOD. CM.	PERÍMETRO PUL. CM.
12542	CERCO	6	4.60	24.42	17.54
12543	JUNQUILLO	20	6.10	13.57	2.95
12545	CABEZAL	4	6.10	23.54	10.47
12562	ZOCLO	4	6.10	34.34	15.80
12566	SELLO DE HERMETICIDAD	10	6.10	24.35	0.00
12569	INTERMEDIO	4	6.10	21.94	8.58
12576	JUNQUILLO COLONIAL	20	6.10	13.14	2.74
12603	JUNQUILLO DOBLE VIDRIO	20	6.10	10.47	2.30
12617	BATIENTE	6	6.10	21.66	16.02
12756	BATIENTE ABIERTO	8	6.10	30.04	16.25



Este manual esta protegido bajo varias patentes y diseños en tramite.  
Prohibida su reproducción total o parcial.