



MC-450 AD
SOLUCIÓN ESTRUCTURAL

ALUMINIO 6063 T5
NORMA ASTM B221



ESTANQUEIDAD AL AGUA Pa	A1	A2	A3	A4	A5
	<100 Llovizna	100 a 199 Lluvia	200 a 299 Chubasco	300 a 500 Tormenta	>500 Huracán

PERMEABILIDAD AL AIRE Q(m³/h/m²)	P1	P2	P3	P4	P5
	>50 Moderado	50 a 27 Fuerte	26 a 10 Depresión	9 a 3 Tormenta	<3 Huracán

RESISTENCIA AL VIENTO Km/h	V1	V2	V3	V4	V5
	74 a 122 Residencial	123 a 146 Comercial	147 a 195 C. Alto	196 a 232 Edificación	>232 Huracán

EFICIENCIA ENERGÉTICA W/m²k	EE1	EE2	EE3	EE4	EE5
	>5.5 Muy Bajo	5.5 a 4.5 Bajo	4.4 a 3.5 Estándar	3.4 a 2.5 Alto	<2.5 Muy Alto

ASLAMIENTO ACÚSTICO dB	AA1	AA2	AA3	AA4	AA5
	<20 Muy Bajo	20 a 25 Bajo	26 a 31 Estándar	32 a 39 Alto	>39 Muy Alto

*Los resultados pueden variar debido a la modulación, las condiciones y los componentes del sistema.

CUALIDADES



Seguridad y Salud



Hermeticidad



Estética



Aislamiento Acústico



Vidrio Doble

DIMENSIONES MÁXIMAS (1) CLAVE DEL TROQUEL

Consulte al asesor técnico para el cálculo de su proyecto.

GN-507MC

Consulte a un asesor técnico para conocer dimensiones, tipologías y acristalamientos. Los valores de desempeño mostrados en esta ficha técnica son resultado de pruebas de laboratorio internas con referencia a las normas: UNE-EN 12154:2000; UNE-EN 12152:2002; UNE-EN 13116:2001; UNE-EN ISO 12631:2012; UNE-EN ISO 10140-2:2011; así como la norma mexicana NMX-R-060-SCFI-2013 para clasificación y especificación de ventanas y métodos de prueba de CUPRUM en colaboración con proveedores certificados.

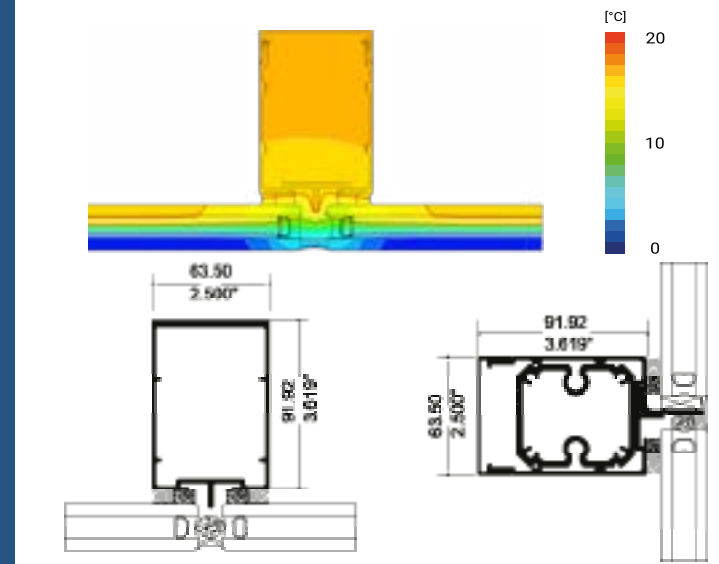

Consulte a uno de nuestros asesores técnicos en la siguiente dirección de correo electrónico: eurovent@cuprum.com

TALLER CERTIFICADO
EUROVENT



Aluminio 100% reciclable



Encuétralo en Cuprum Plus



Participa en certificación Leed



/CuprumEurovent



@cuprumeurovent



/CuprumEurovent

ACCESORIOS



Tornillo punta de broca



Sellador Estructural y de Intemperie



Tapón de Hermeticidad PN-0906



Soft Rod



Cinta espaciadora Doble adhesiva

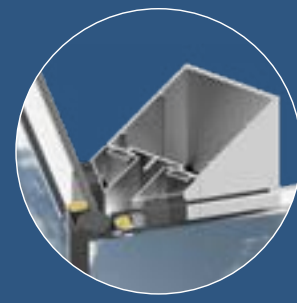

ACRISTALAMIENTOS

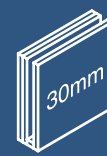

*Vidrios laminados de acuerdo a dimensiones nominales.

PERFILES Y COMPLEMENTOS

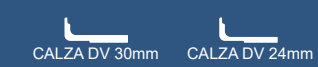
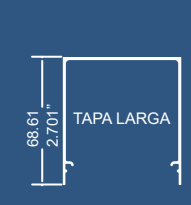
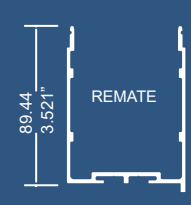
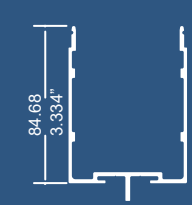
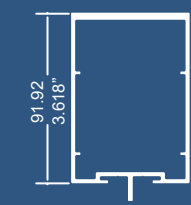
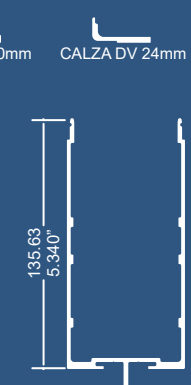
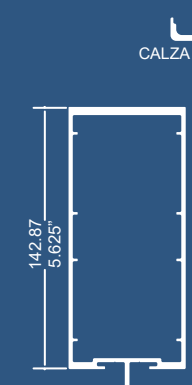
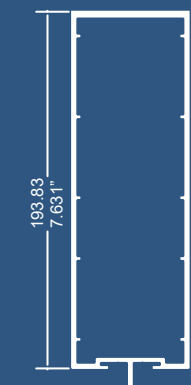

ACABADOS (2)

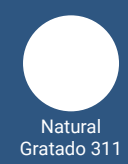

Natural Gratado 311

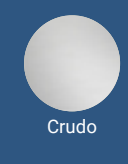

Crudo

GARANTÍA DE ACABADO LÍNEA EUROVENT
Normas: AAMA-611-12, AAMA-603-02 y NMX-138

(1) Puede variar según ubicación geográfica.
(2) Consulte acabados disponibles.

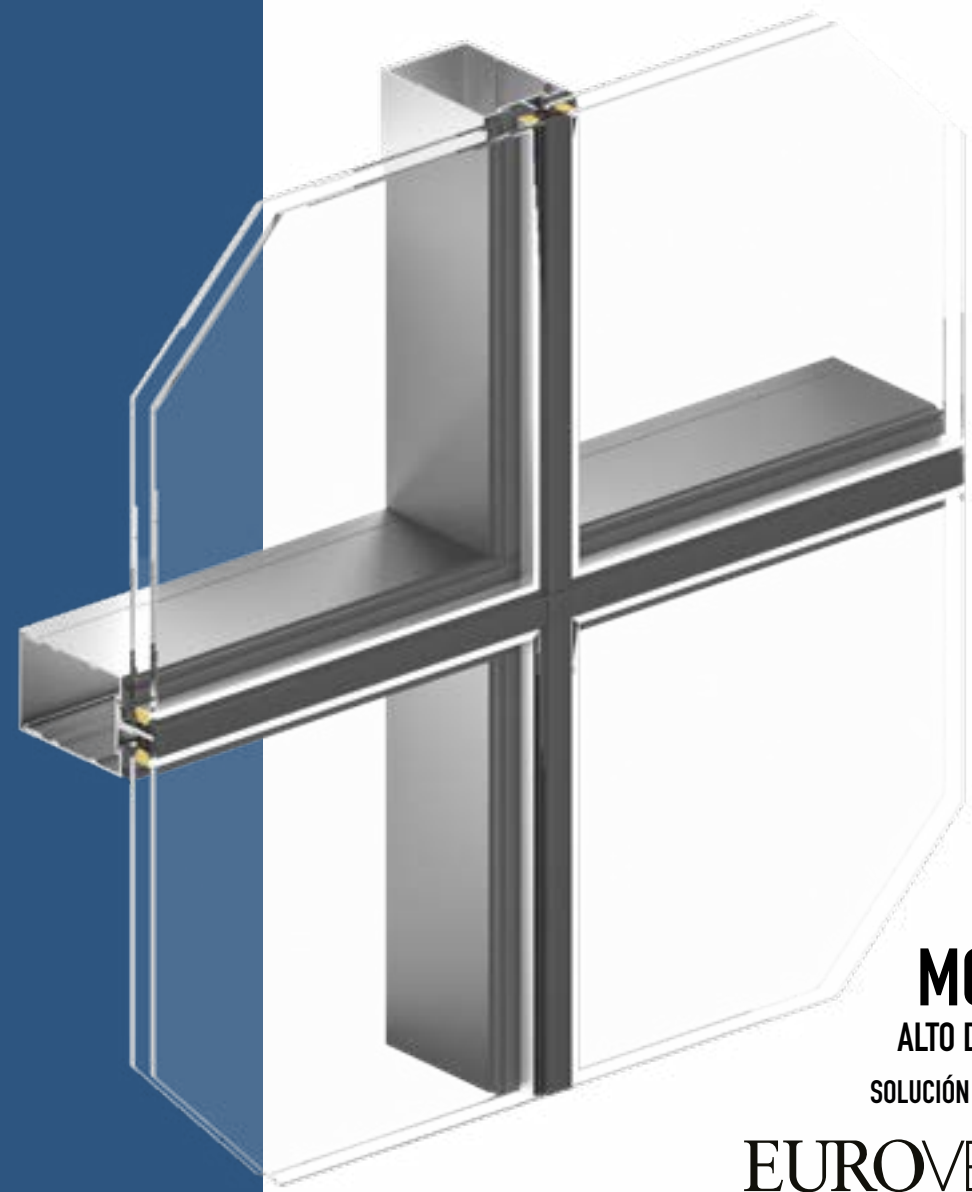

MC-450
ALTO DESEMPEÑO
SOLUCIÓN ESTRUCTURAL