



CUPRUM



# EUROVENT

 CUPRUM

# INTRODUCCIÓN

En **CUPRUM**, nos hemos consolidado como la opción de referencia en el sector de la construcción, ofreciendo un portafolio diversificado de productos diseñados para satisfacer las necesidades más exigentes de nuestros clientes. Nuestra dedicación a la excelencia se refleja en la calidad de nuestros materiales, el servicio personalizado y nuestra atención a los detalles, posicionándonos como el socio ideal para proyectos arquitectónicos de cualquier escala.

Nuestra marca exclusiva, **Eurovent**, ofrece una línea de puertas y ventanas de alto desempeño, desarrolladas con tecnología avanzada y diseños europeos que garantizan la máxima eficiencia. Estas soluciones arquitectónicas están diseñadas para cumplir con los más altos estándares de calidad y funcionalidad, brindando resultados superiores en cada proyecto

## BENEFICIOS



### SEGURIDAD Y HERMETICIDAD

Sistema que impide la entrada de polvo, agua y diversos contaminantes.



### DURABILIDAD

Aluminio de alta calidad para ofrecer acabados resistentes sin sacrificar estética.



### ESTILO

Variedad de estilos que conjugan a la perfección con tu espacio.



### AISLAMIENTO TÉRMICO

Doble vidrio que mantiene la temperatura ideal y disminuye tu gasto en energía.





### AISLAMIENTO ACÚSTICO

Con la tecnología de aislamiento acústico cuidamos tus momentos de tranquilidad de tu espacio.

# C L A S S I C

	<b>Fijos</b>	
	Fijo Serie 35	6
	Fijo Serie 50	7
	Fijo Serie 60	10
	Fijo Serie 70	11
	Fijo Serie 140	14
	<b>Corredizas</b>	
	Ventana Corrediza Serie 50	17
	Ventana Corrediza Serie 60	18
	Ventana y Puerta Corrediza Serie 70	20
	<b>Cortinas</b>	
	Cortina Anticiclónica HV	25
	<b>Ventanas Batientes</b>	
	Ventana Batiente y Proyección Serie 35 "	27
	<b>Puertas Batientes</b>	
	Puerta Comercial Serie 50	28
	Puerta Residencial Serie 50	30
	<b>Muro Cortina</b>	
	Muro Cortina Serie MC-500	33

# P R E M I U M

	<b>Fijos</b>	
	Fijo Serie 45	37
	Fijo Serie 80	39
	Fijo Serie 100 AR	41
	Fijo Serie 150	42
	<b>Corredizas</b>	
	Ventana y puerta Corrediza Serie 80	43
	Puerta Corrediza Serie 100AR	45
	Puerta Corrediza Serie 150	52
	<b>Ventanas Batientes</b>	
	Ventana Serie 45	55
	<b>Puertas Batientes</b>	
	Puerta Serie 45	57
	Puerta Serie 45 Camara Europea	59
	<b>Muro Cortina</b>	
	Muro Cortina Serie MC-450AD	61
	Indice general por claves	68

## **Pintura electrostática**

- 100 - Blanco
- 101 - Hueso
- 108 - Champagne
- 107 - Negro
- 184 - Chocolate
- 737 - Gris Europa

## **Anodizados**

- 005 - Champagne Brillante
- 010 - Natural Brillante
- 011 - Natural Mate
- 040 - Champagne Mate
- 084 - Bronce oscuro

## **Acabados Madera**

- 601 - Madera Cerezo
- 603 - Nogal Texturizado

Pregunta a tu asesor comercial los acabados disponibles en tu zona o tu sucursal.





**EUROVENT**   
C L A S S I C



CUPRUM



CUPRUM



CLASSIC  
SERIE

S35



FIJO

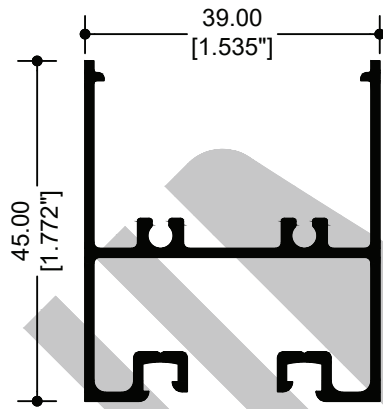

**12606**  
BOLSA

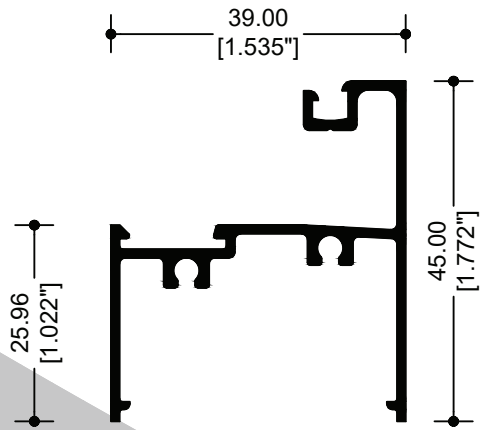

**12608**  
ESCALONADO

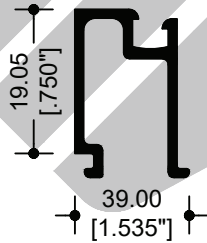

**12609**  
JUNQUILLO

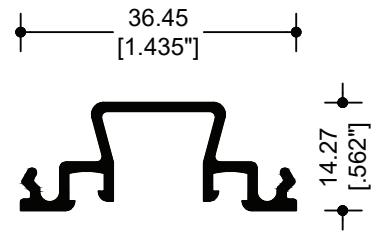

**12607**  
TAPA BOLSA

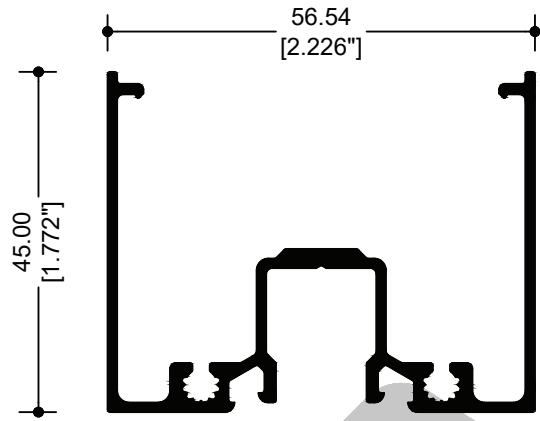

**12504**  
BOLSA

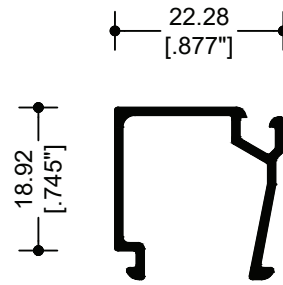

**12507**  
JUNQUILLO

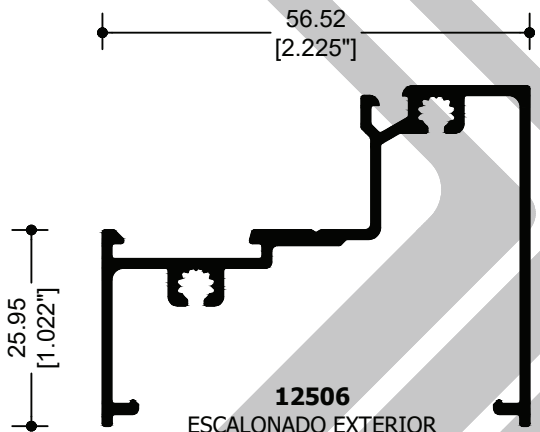

**12506**  
ESCALONADO EXTERIOR

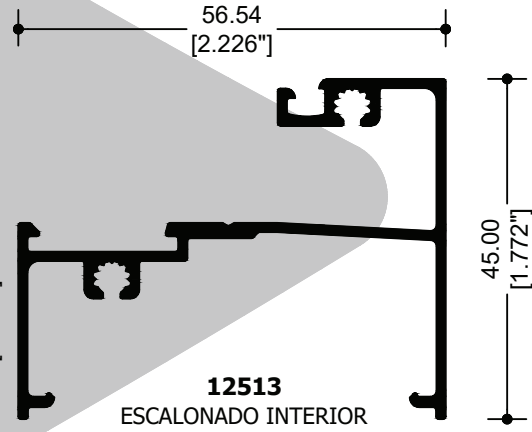

**12513**  
ESCALONADO INTERIOR



**12505**  
TAPA BOLSA

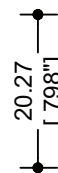

CLASSIC  
SERIE  
**S50**  
FIJO

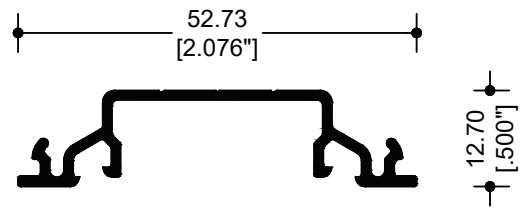
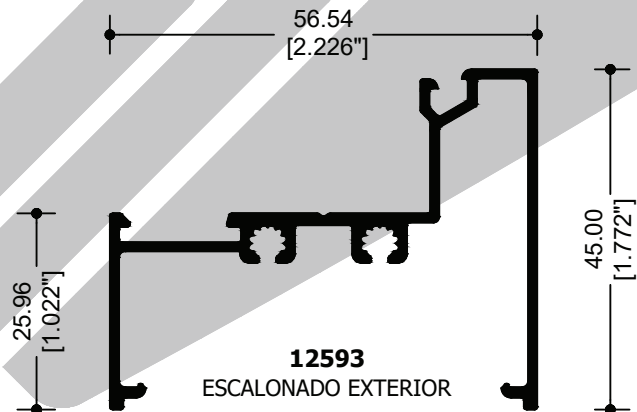
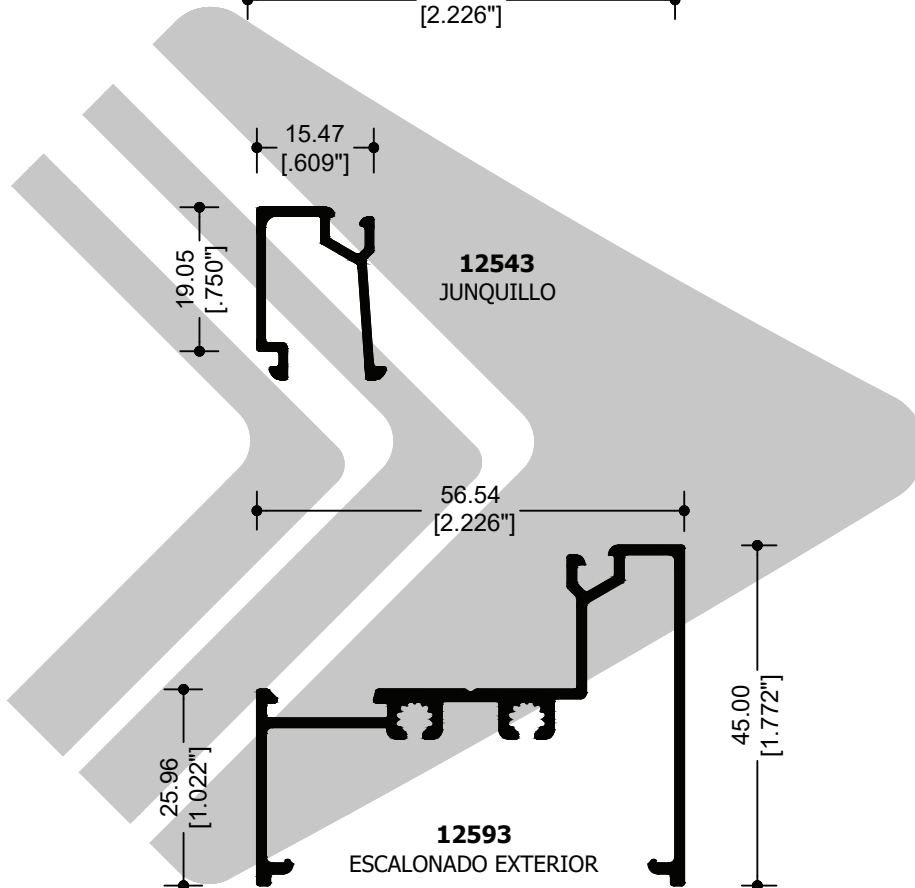
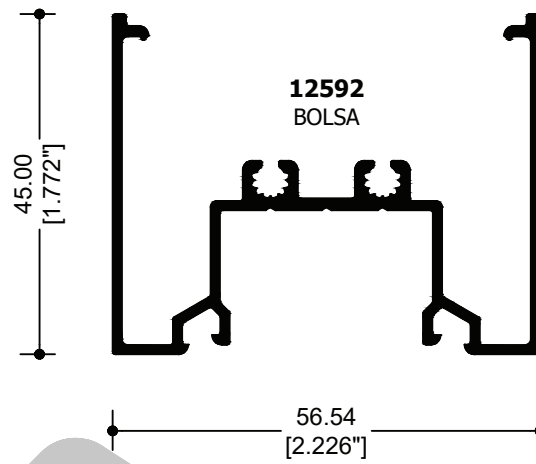

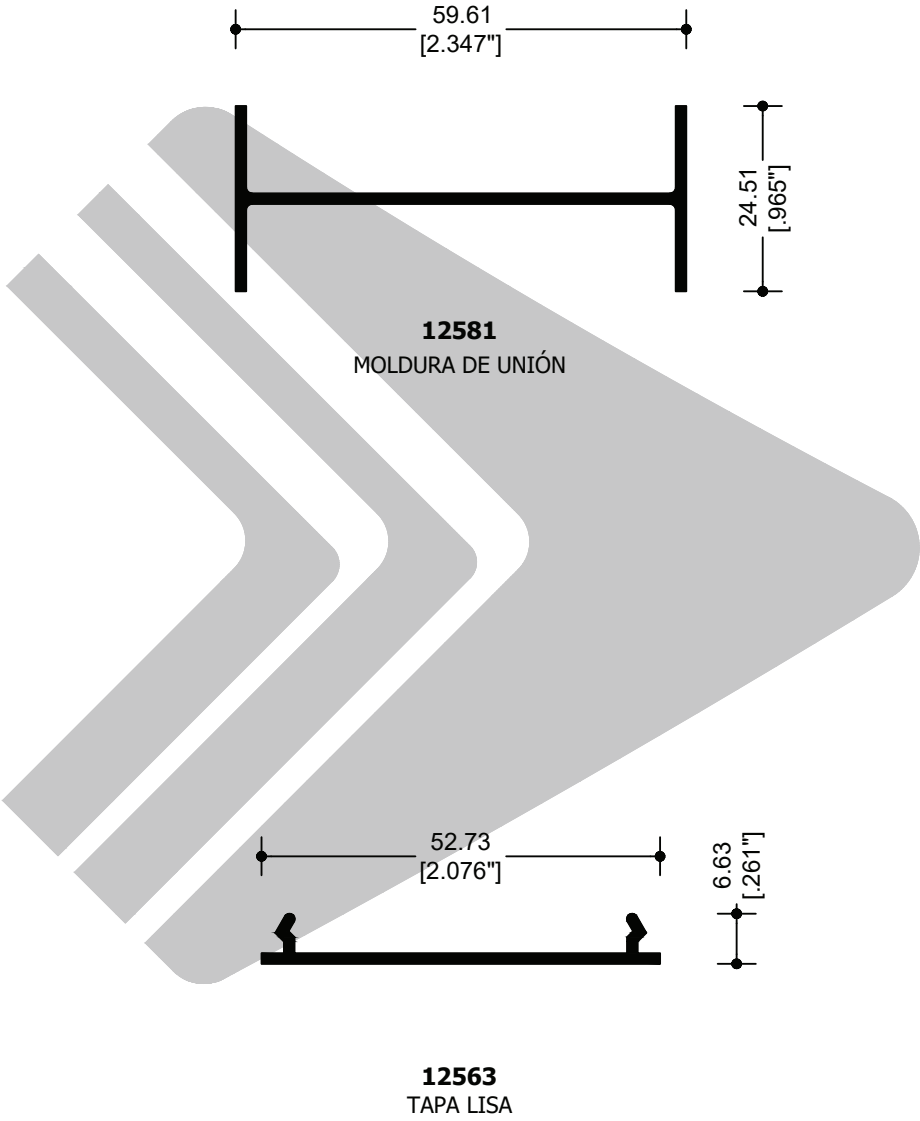

FIJO

CLASSIC

SERIE

S50

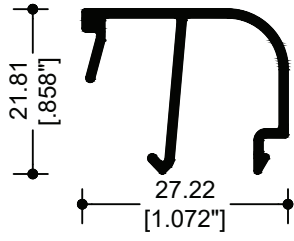

**82029**  
JUNQUILLO VIDRIO SENCILLO

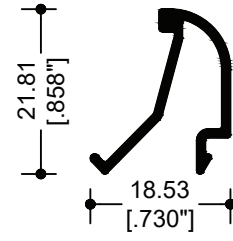

**82030**  
JUNQUILLO VIDRIO DOBLE

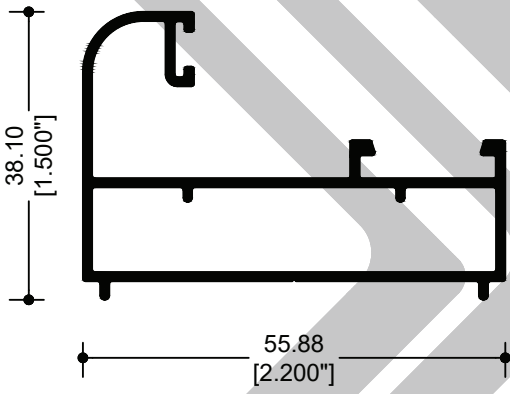

**82079**  
FIJO 2 VIAS S-60

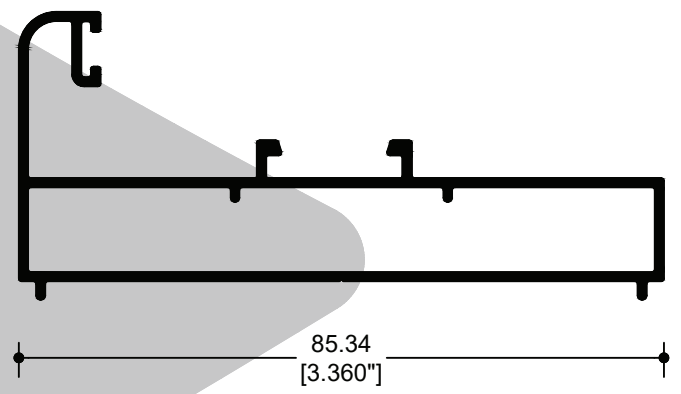

**82093**  
FIJO 3 VIAS S-60

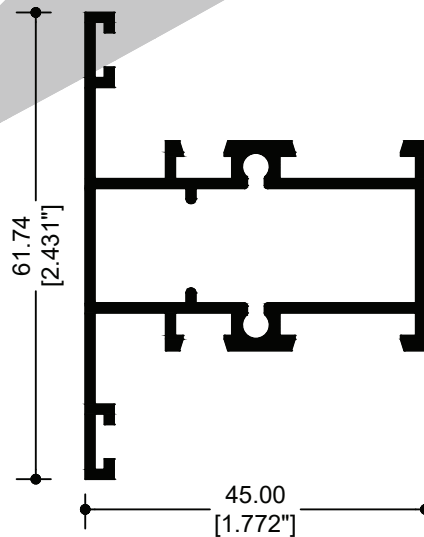

**62041**  
INTERMEDIO CUADRÍCULA



CLASSIC  
SERIE

**S60**



FIJO



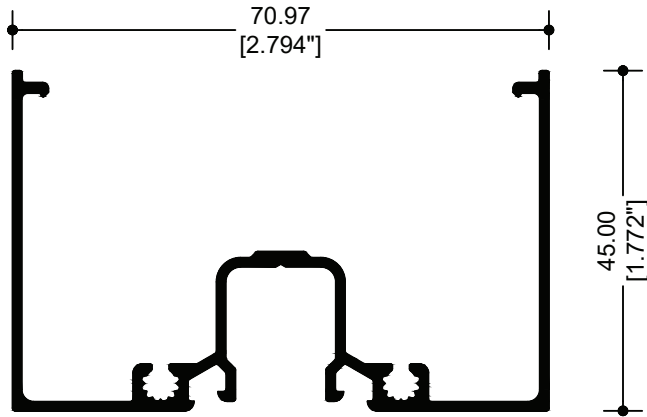

**22504**  
BOLSA

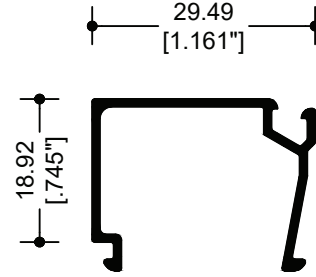

**42507**  
JUNQUILLO

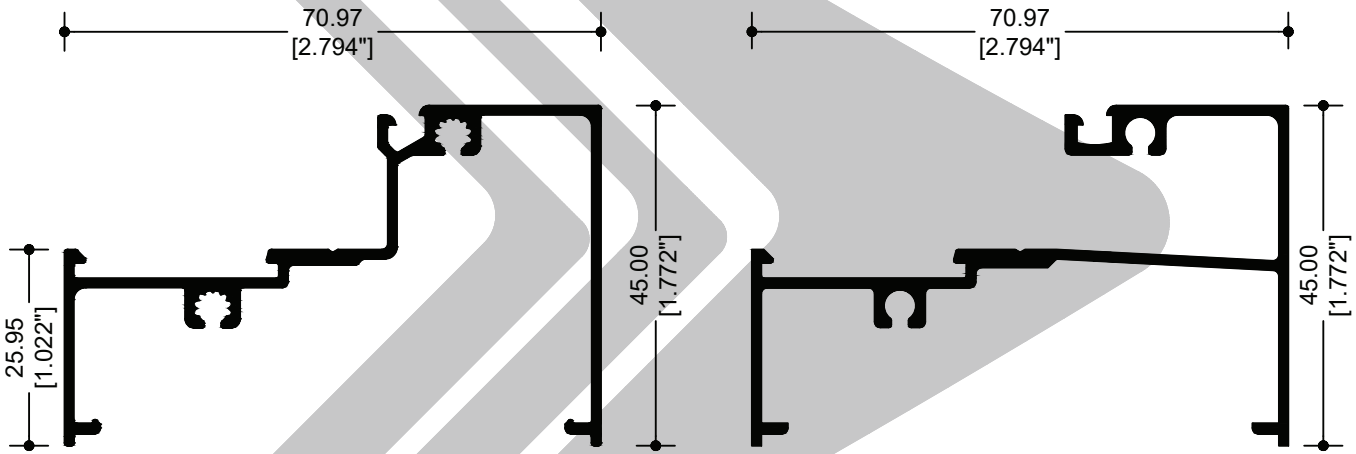

**32506**  
ESCALONADO EXTERIOR

**22513**  
ESCALONADO INTERIOR

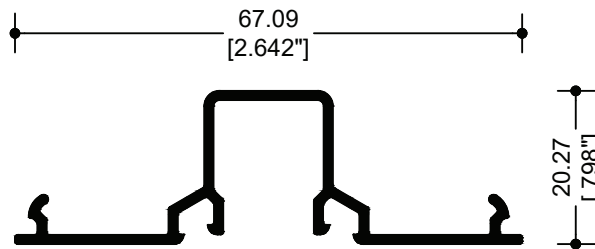

**42505**  
TAPA BOLSA



CLASSIC

SERIE

**S70**



FIJO

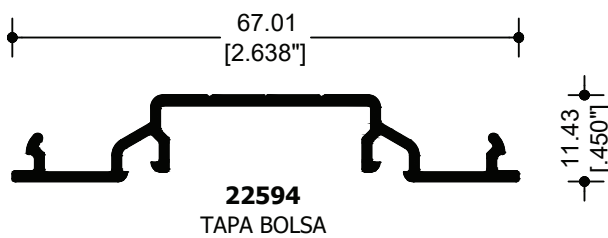
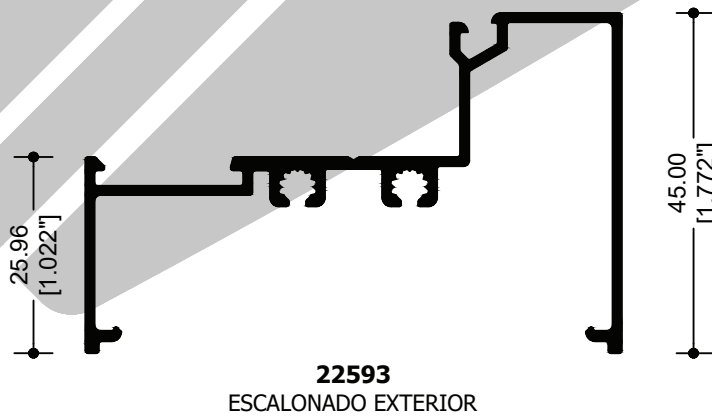
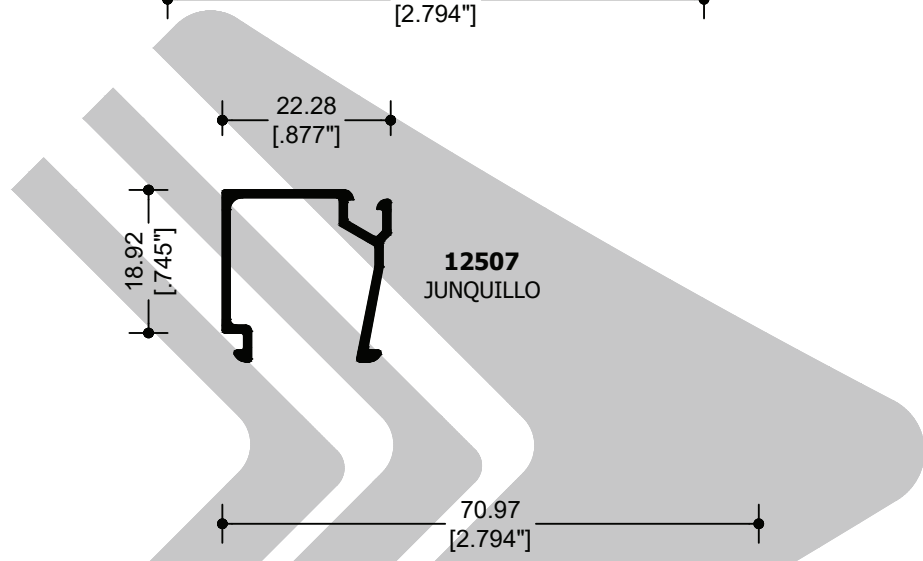
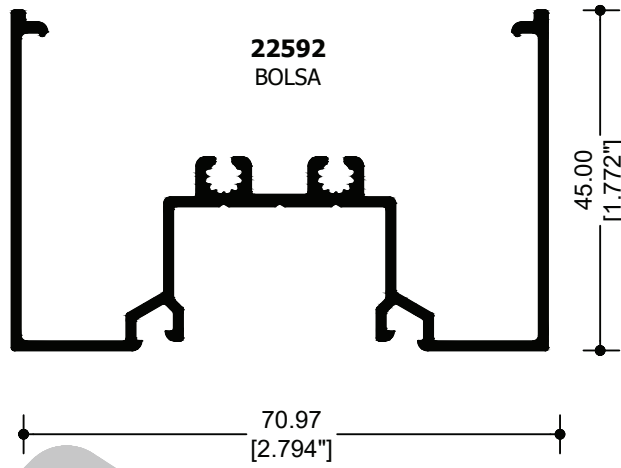

CLASSIC  
SERIE

S70



FIJO

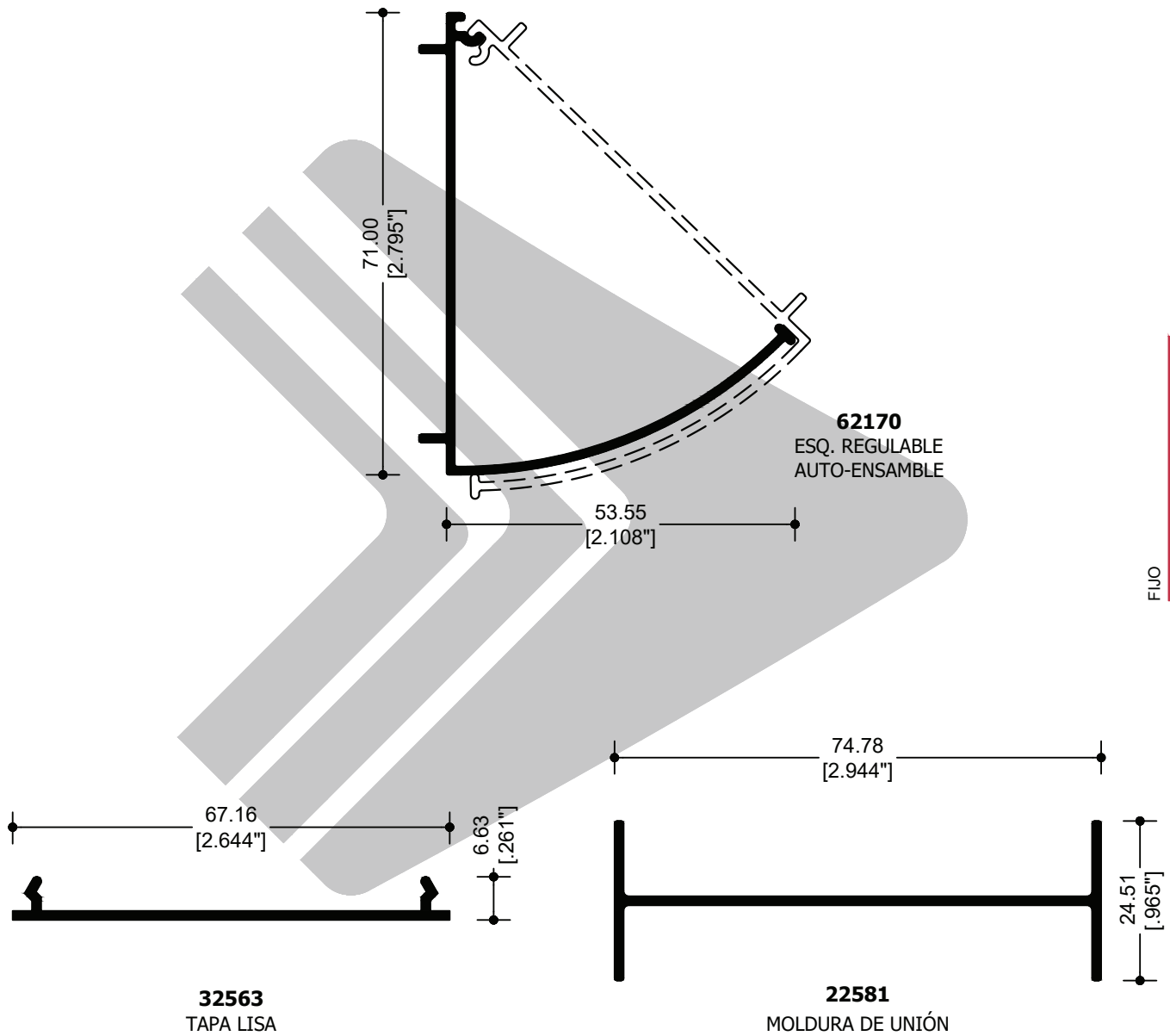

CLASSIC  
SERIE  
**S70**  
FIJO

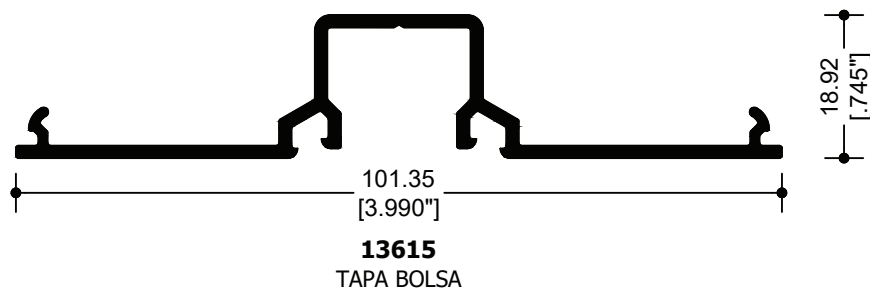
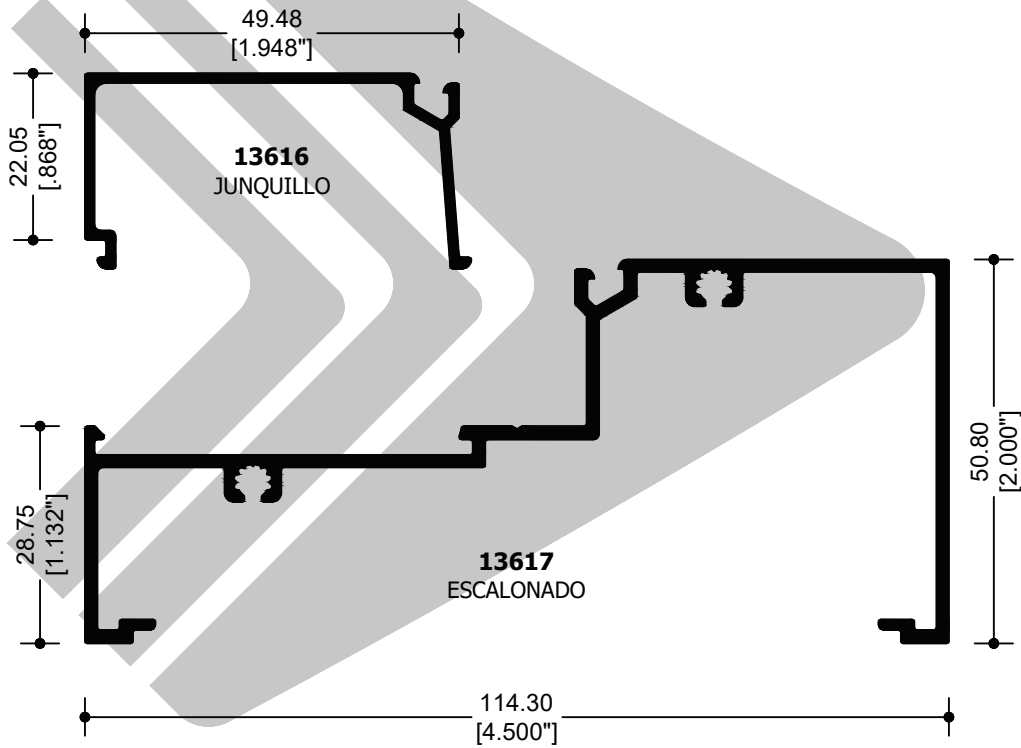
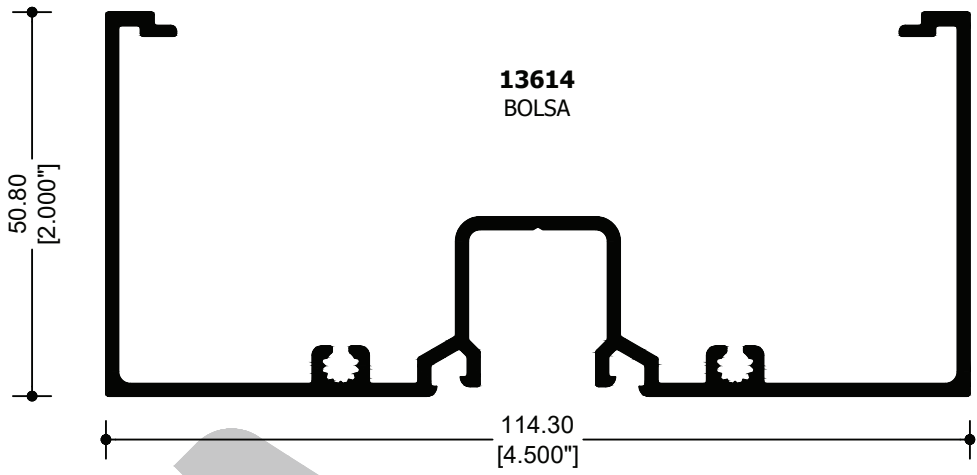

CLASSIC  
SERIE  
**S140**  
FIJO

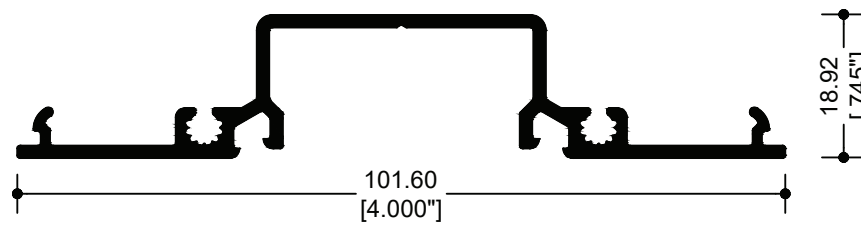
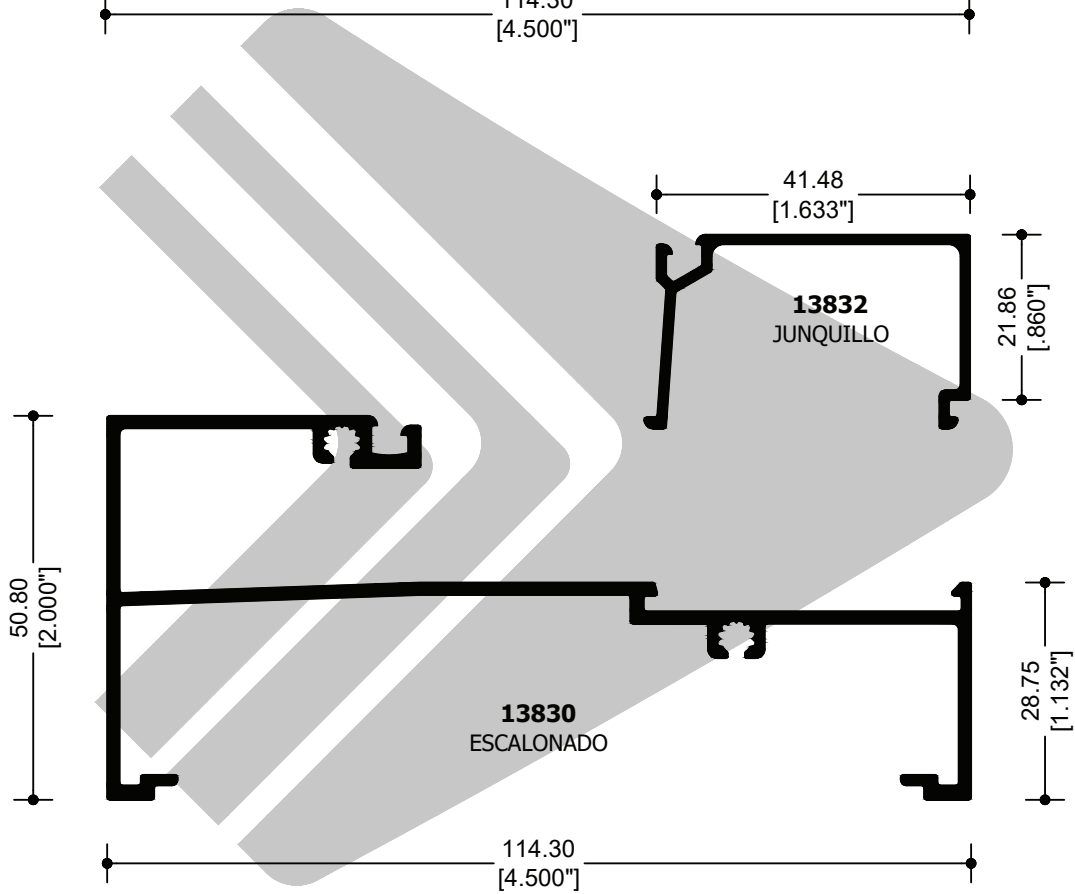
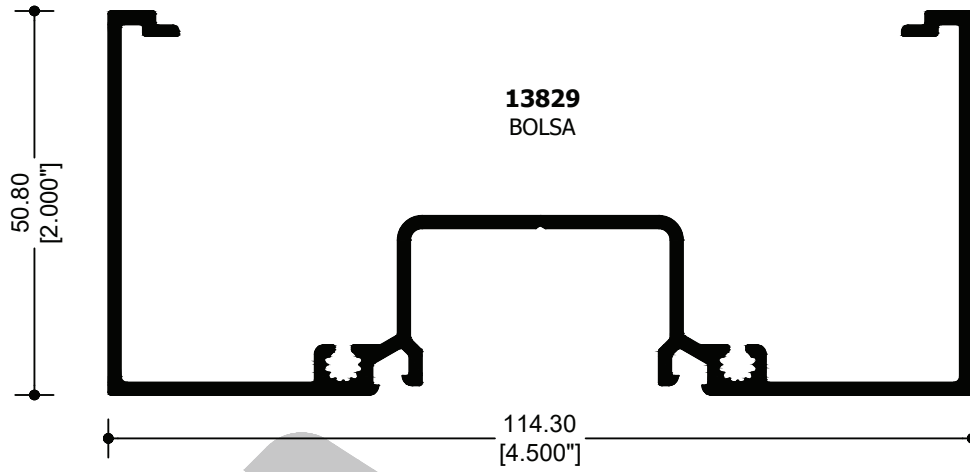

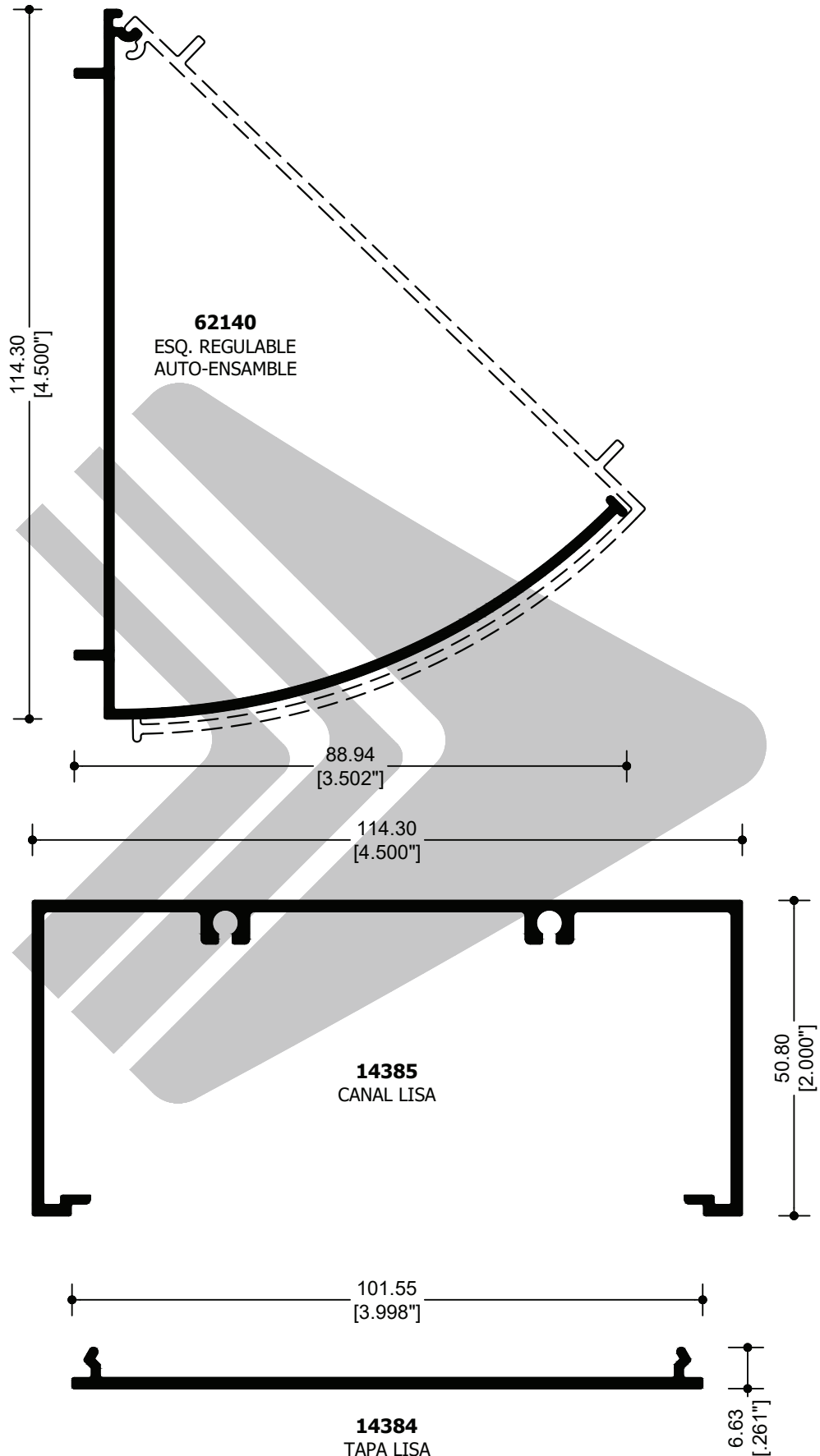

CLASSIC  
SERIE

S140



FIJO

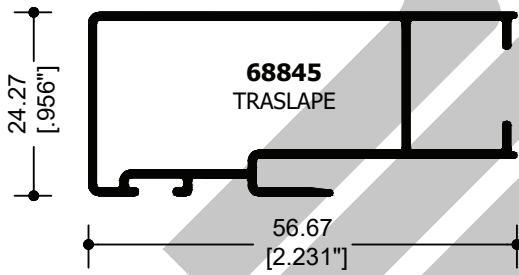
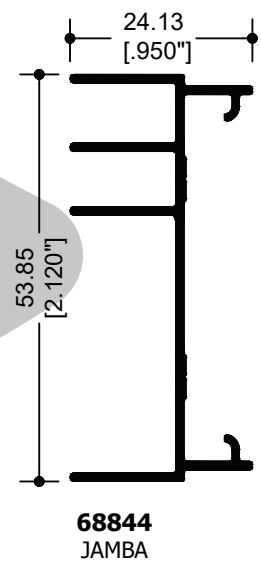
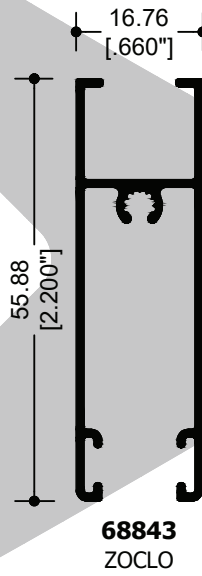
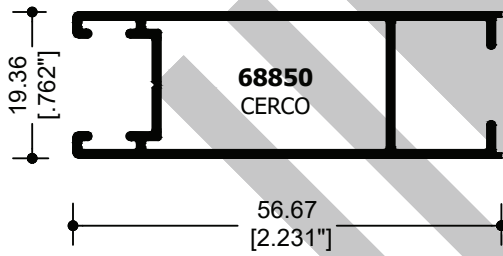
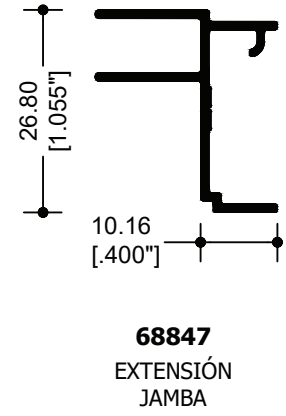
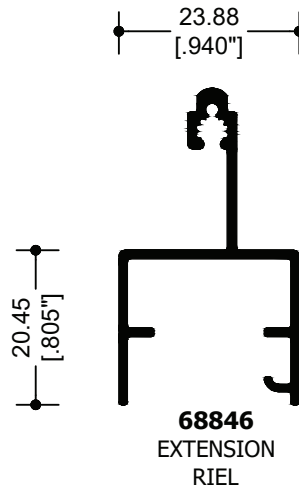
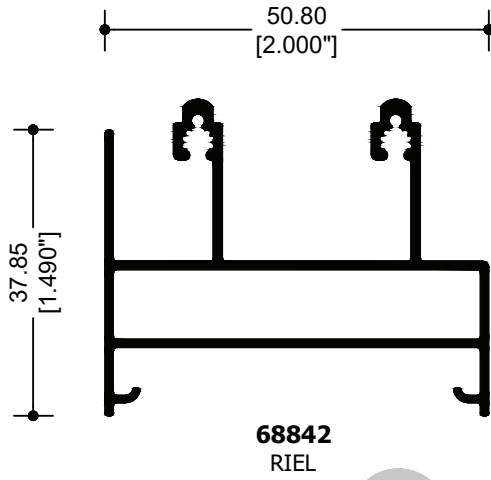

CLASSIC  
SERIE  
**S50**  
CORREDIZA

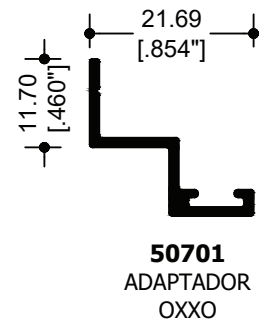
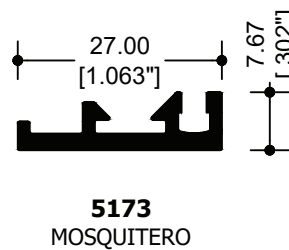
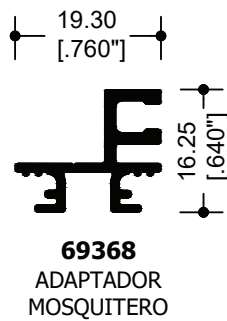
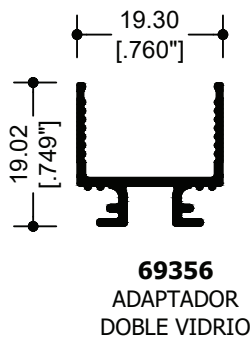

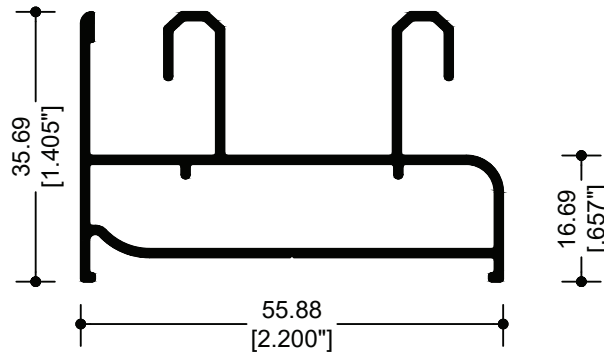

**87896**  
MARCO 2 VIAS S-60

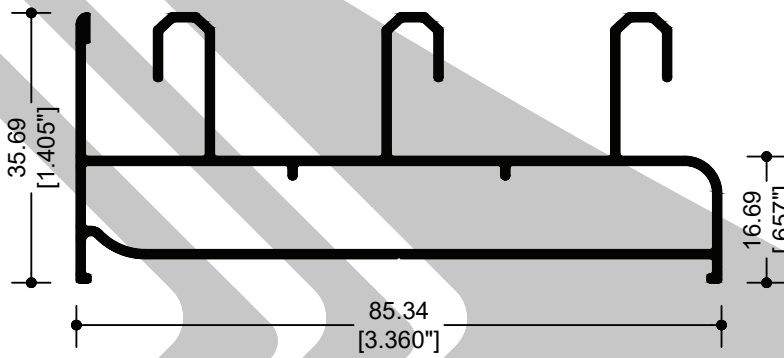

**88300**  
MARCO 3 VIAS S-60

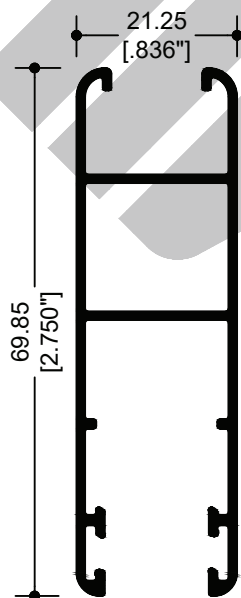

**67894**  
CERCO PUERTA

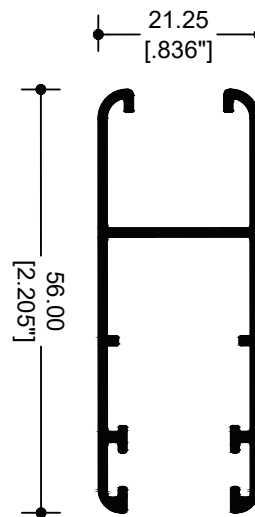

**62066**  
CERCO VENTANA



CLASSIC  
SERIE

S60



CORREDIZA



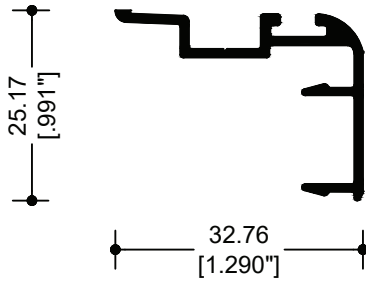

**62070**  
TRASLAPE  
VENTANA

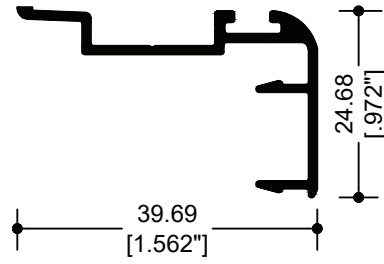

**67899**  
TRASLAPE  
PUERTA

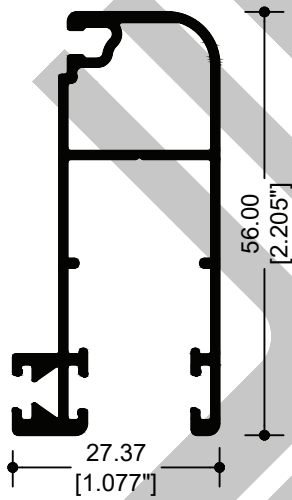

**68337**  
MOSQUITERO  
BAJO

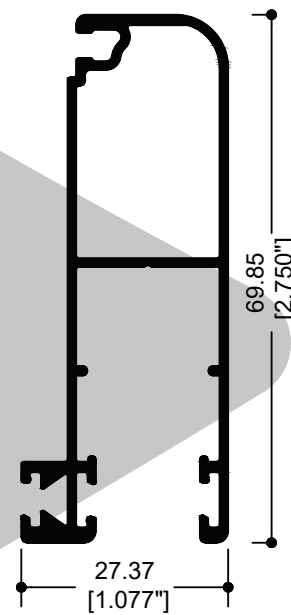

**68299**  
MOSQUITERO  
EXT.

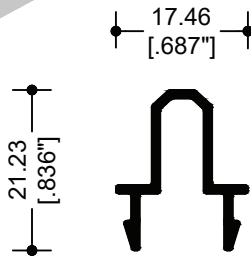

**62078**  
ADAPTADOR XX



  
 CLASSIC  
 SERIE  
**S70**  
  
 CORREDIZA

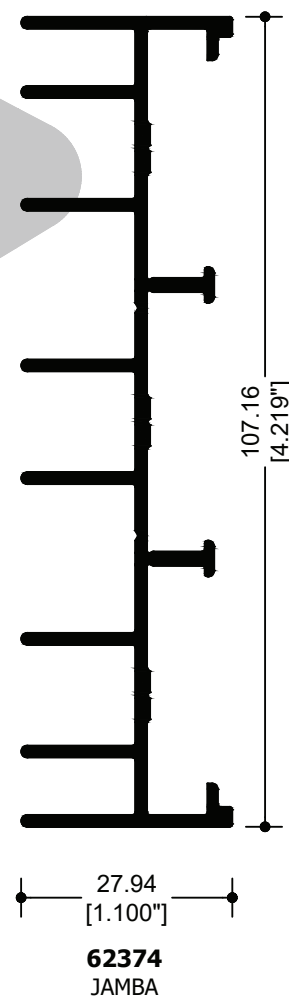
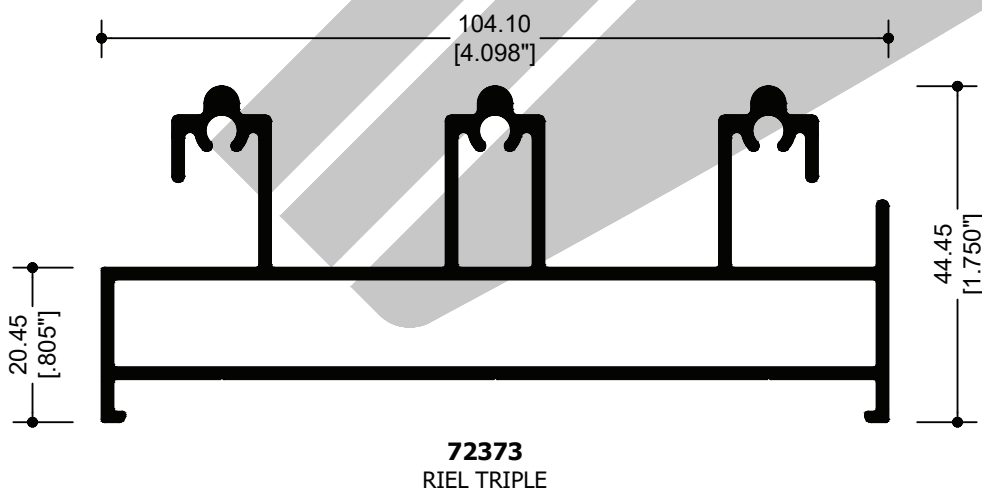
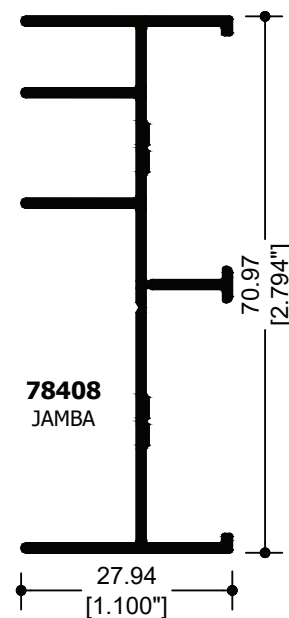
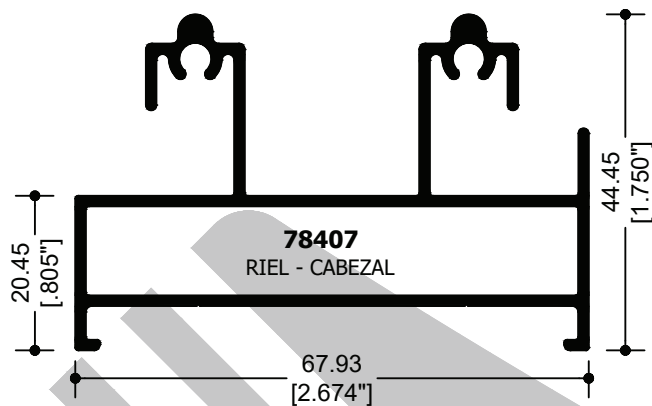

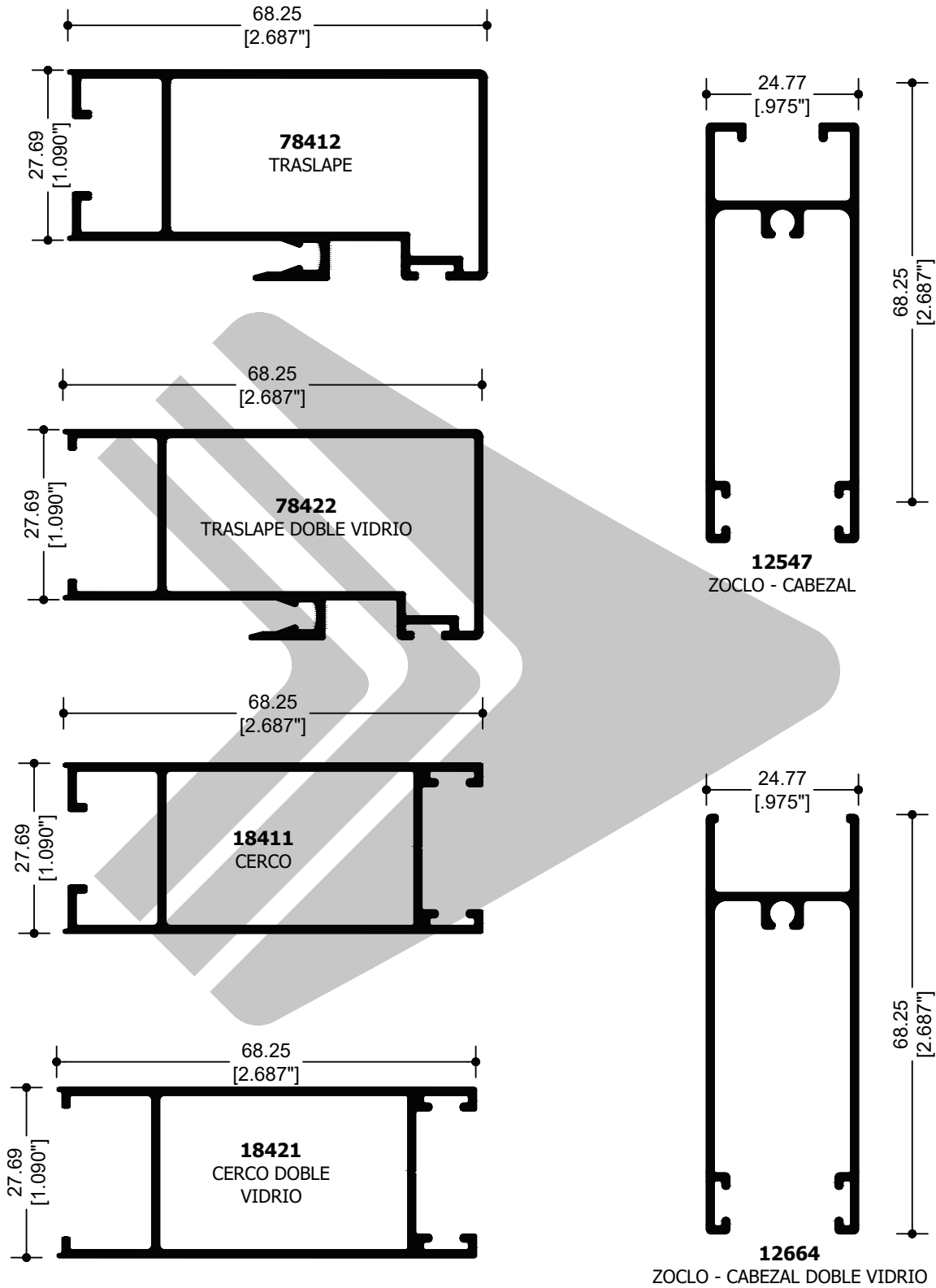

  
 CLASSIC  
 SERIE  
**S70**  
  
 CORREDIZA

CLASSIC  
SERIE  
**S70**  
CORREDIZA

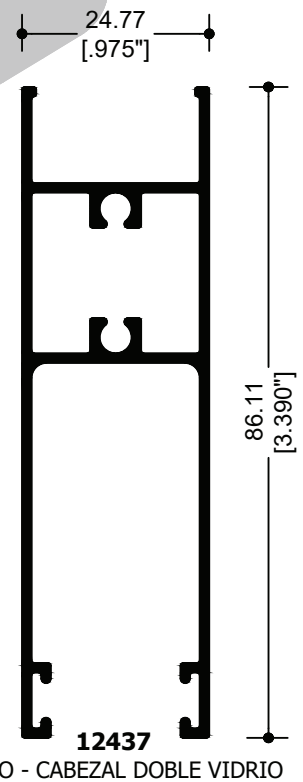
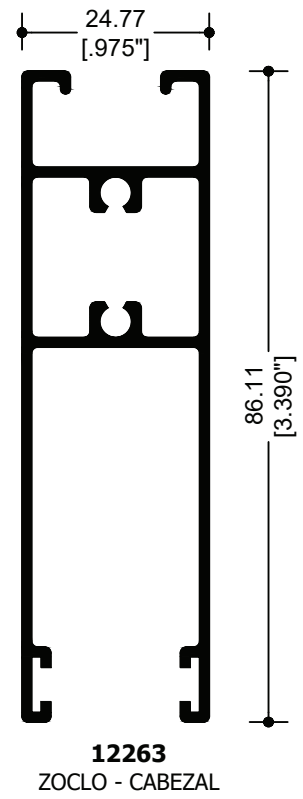
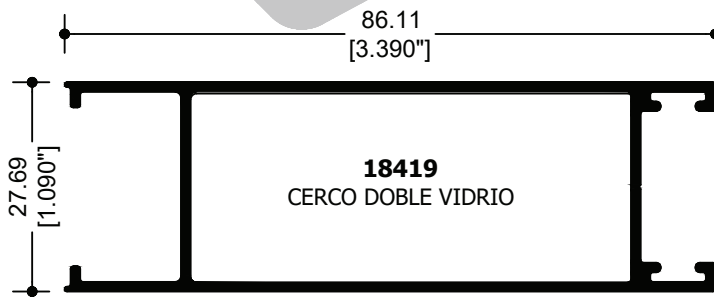
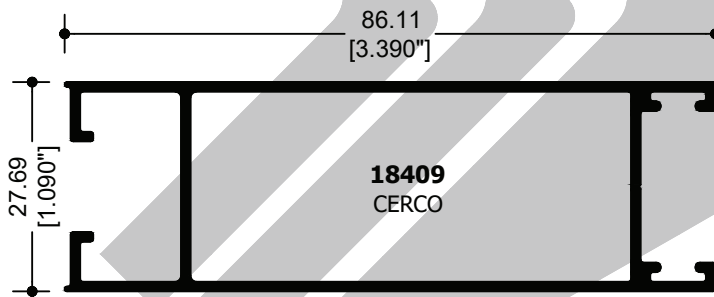
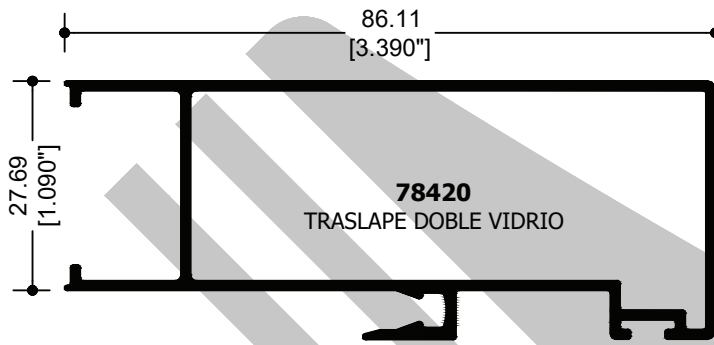
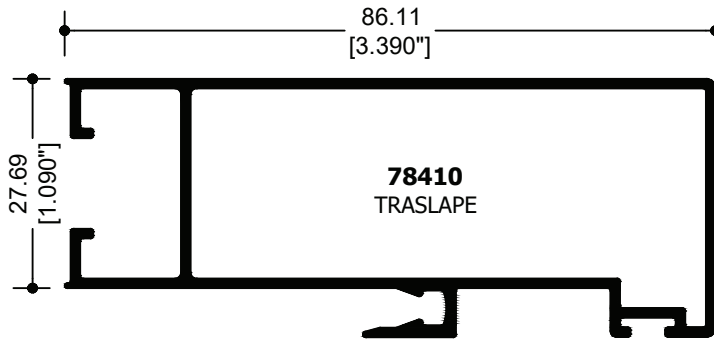

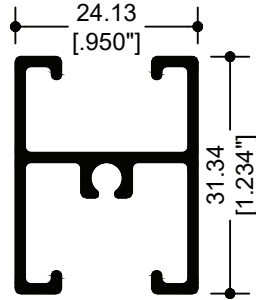

**12456**  
INTERMEDIO

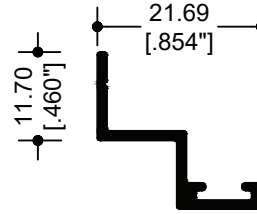

**50701**  
ADAPTADOR  
OXO

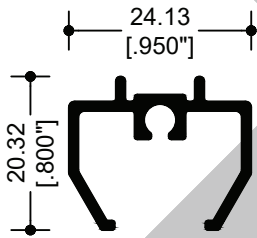

**14702**  
PERFIL P/CUADRÍCULA

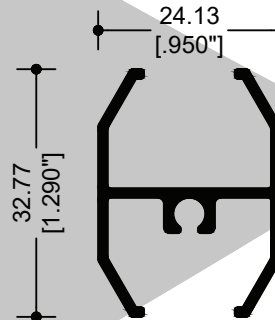

**14918**  
PERFIL P/CUADRÍCULA

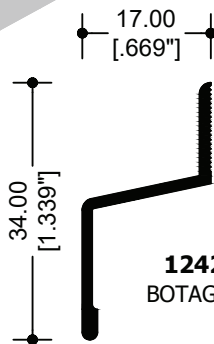

**12428**  
BOTAGUAS



CLASSIC

SERIE

**S70**



CORREDIZA

CLASSIC  
SERIE  
**S70**  
CORREDIZA

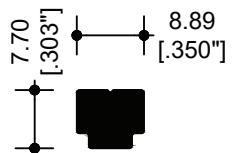

**14412**  
CONECTOR P/REFUERZO

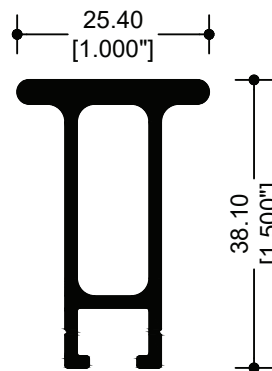

**14411**  
REFUERZO 1 1/2"

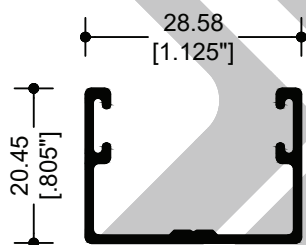

**18413**  
GUÍA INFERIOR

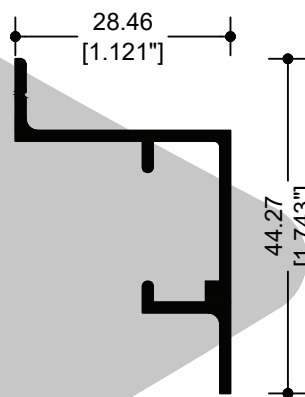

**11409**  
CABEZAL MOSQUITERO

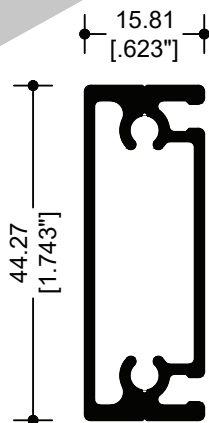

**11411**  
MOSQUITERO

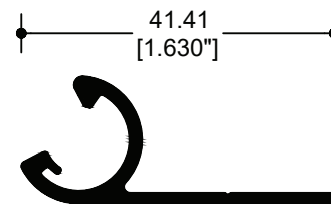
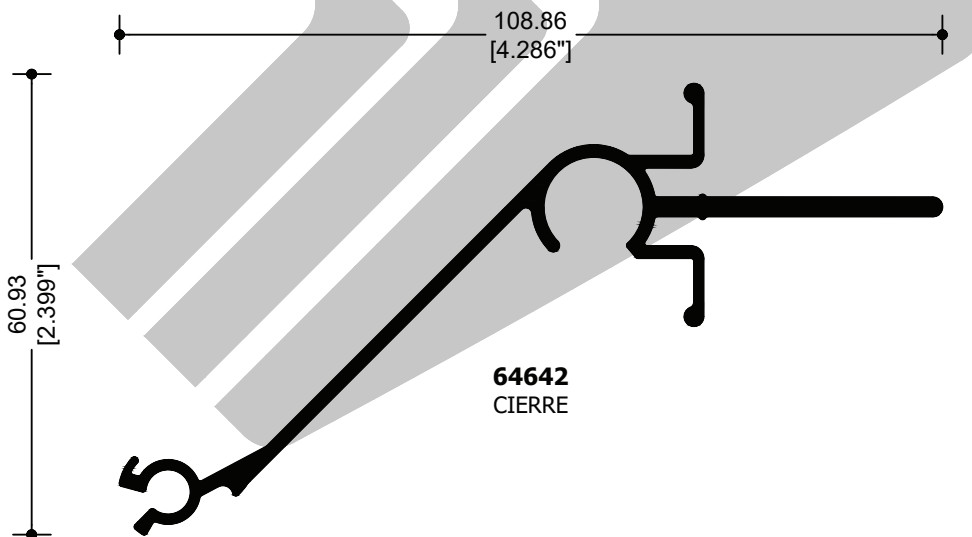
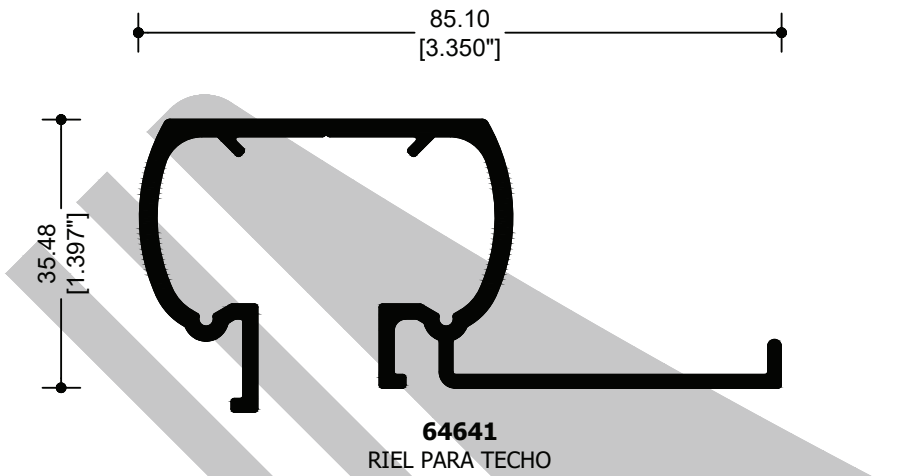
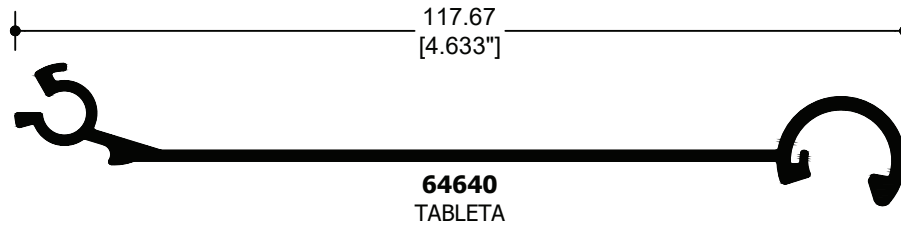

CLASSIC  
SERIE  
CORTINA ANTICICLÓNICA  
**CA HV**



\*Cert. No: 13-0306.01  
CUMPLE EL PROTOCOLO (High Velocity Hurricane Zone)  
Velocidades Extremas en Zona de Huracanes  
Certificación realizada en el Condado de Miami Dade por el  
laboratorio FENESTRATION TESTING LABORATORY, INC.

\*EN TRAMITE DE RENOVACIÓN

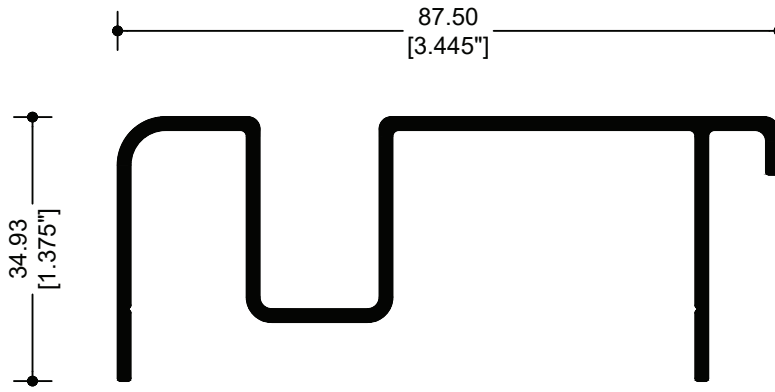

**64644**  
ADAPTADOR AJUSTABLE MACHO

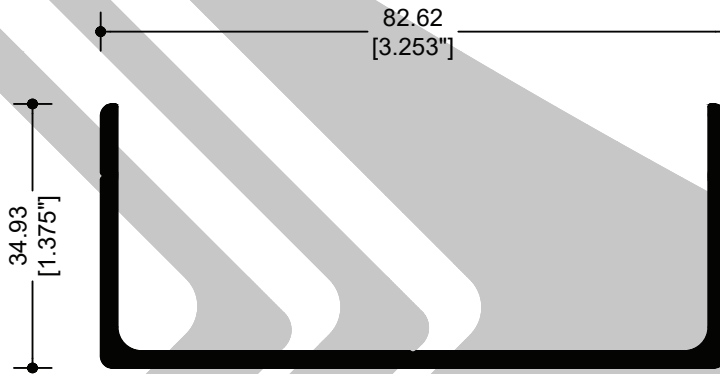

**64645**  
ADAPTADOR AJUSTABLE HEMBRA

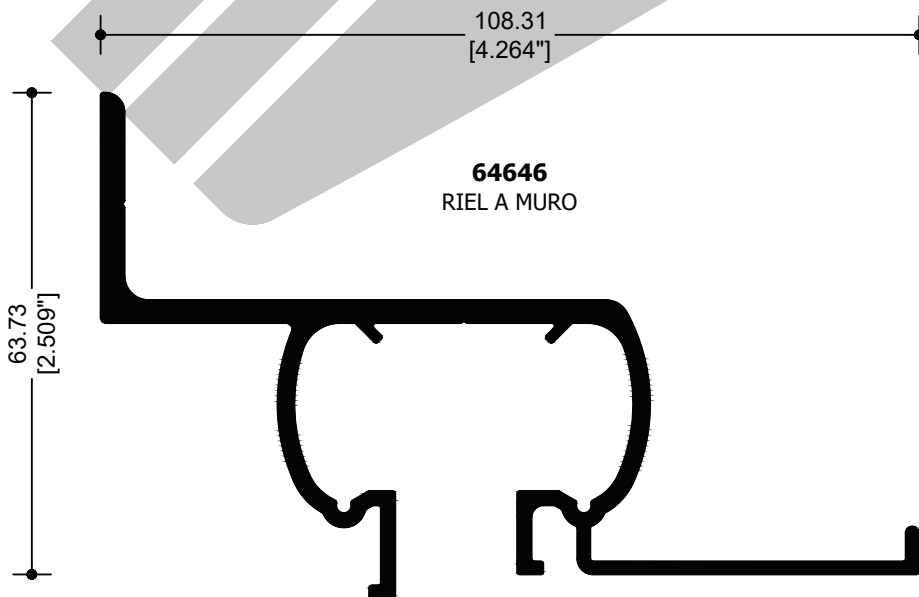

**64646**  
RIEL A MURO





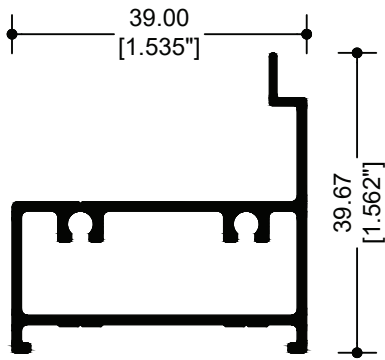

**12273**  
CONTRAMARCO

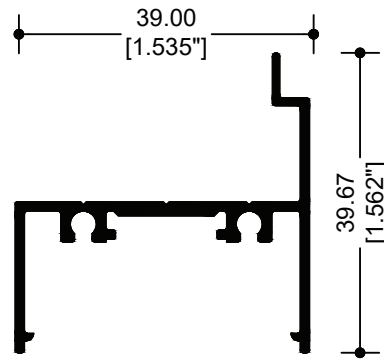

**13363**  
CONTRAMARCO

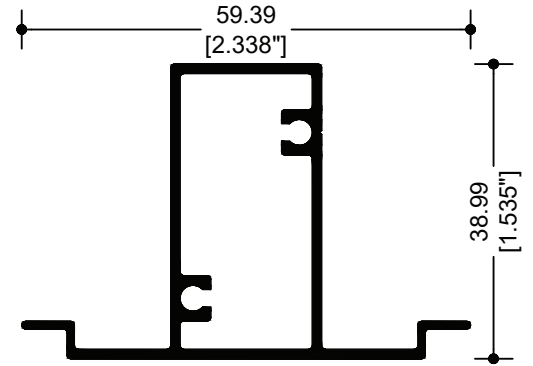

**12275**  
INTERMEDIO

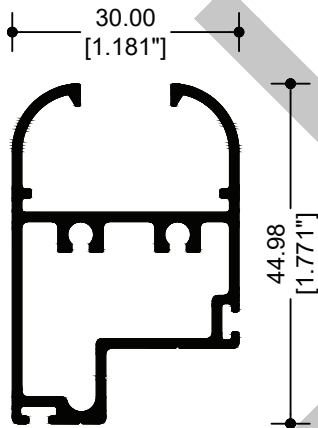

**12274**  
MARCO COLONIAL

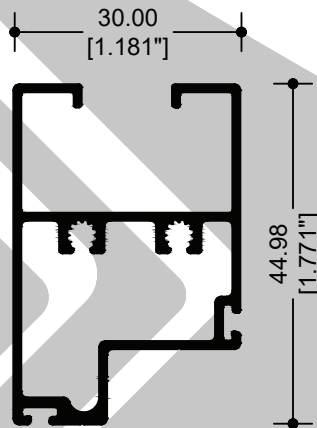

**12276**  
MARCO

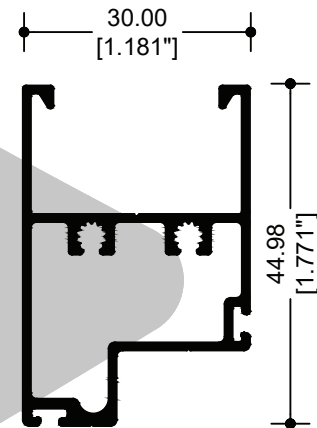

**12277**  
MARCO DOBLE VIDRIO

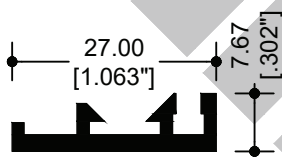

**5173**  
MOSQUITERO

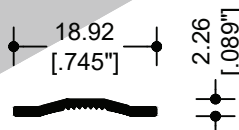

**81642**  
CUADRÍCULA  
INGLESA EXPUESTA

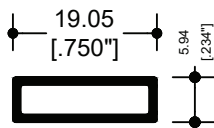

**15043**  
CUADRÍCULA AMERICANA

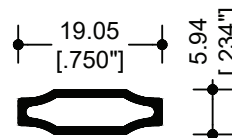

**12393**  
CUADRÍCULA INGLESA DOBLE VIDRIO

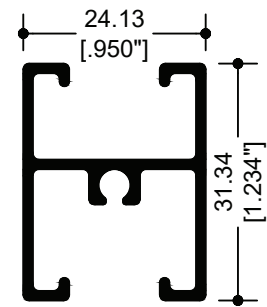

**12456**  
INTERMEDIO



CLASSIC  
SERIE  
**S50**  
BATIENTE PUERTA

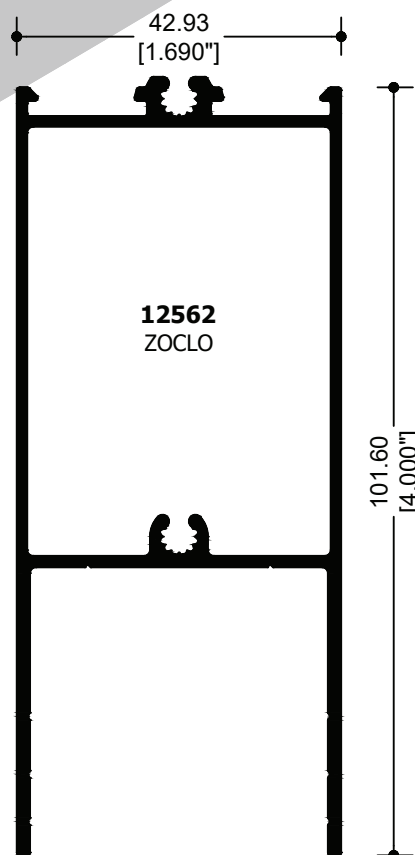
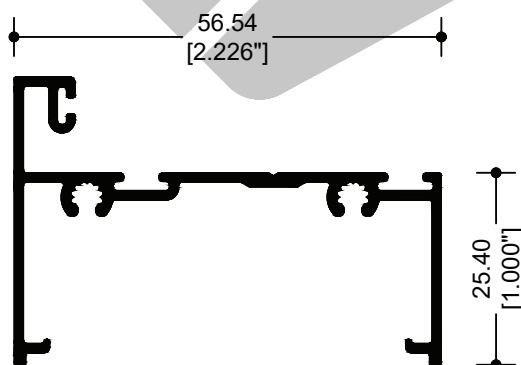
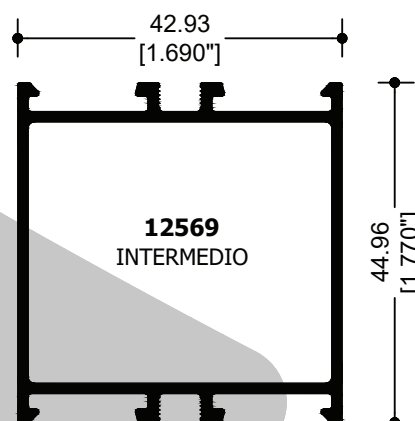
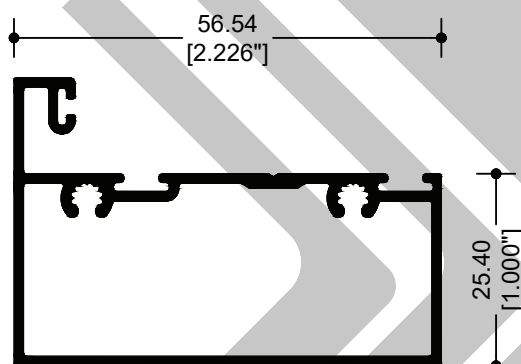
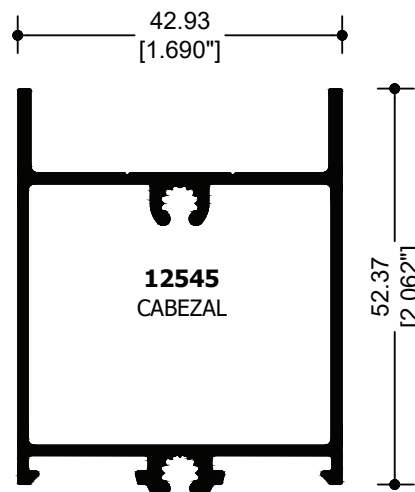
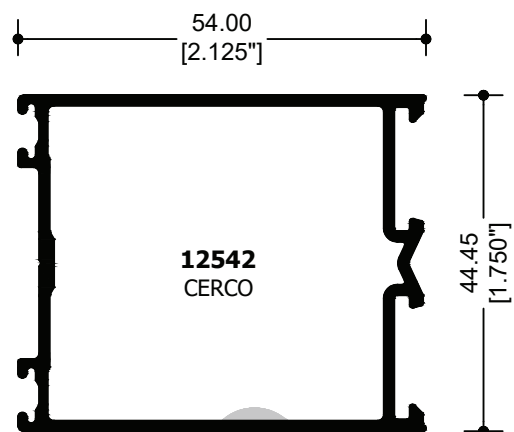

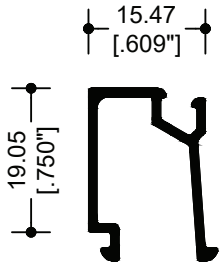

**12543**  
JUNQUILLO

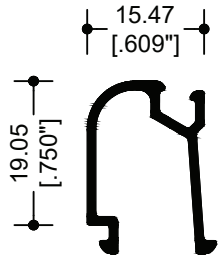

**12576**  
JUNQUILLO COLONIAL

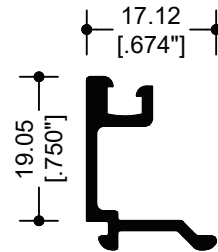

**12603**  
JUNQUILLO DOBLE VIDRIO (18mm)

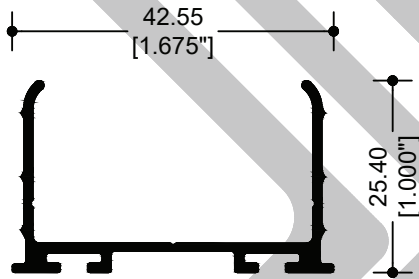

**12566**  
SELLO DE HERMETICIDAD

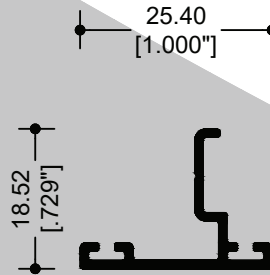

**74272**  
ADAPTADOR INTERMEDIO PLANO

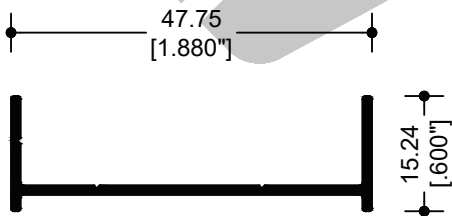

**74268**  
MARCO CELOSIA

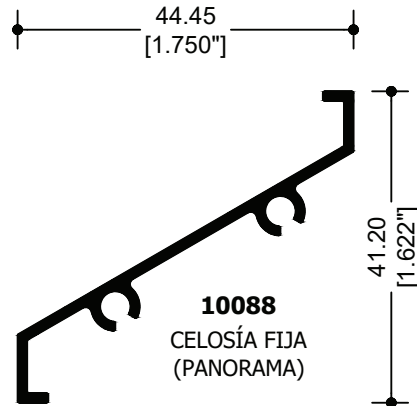

**10088**  
CELOSÍA FIJA (PANORAMA)



CLASSIC

SERIE

S50



BATIENTE PUERTA

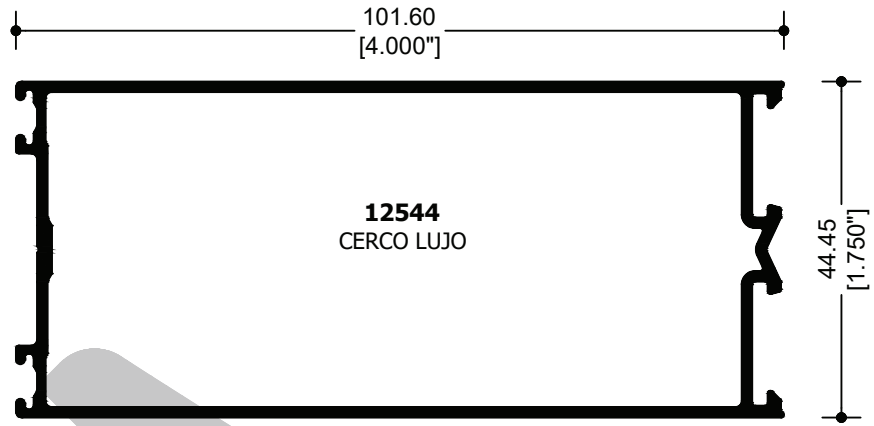

CLASSIC  
SERIE  
**S50**  
BATIENTE PUERTA

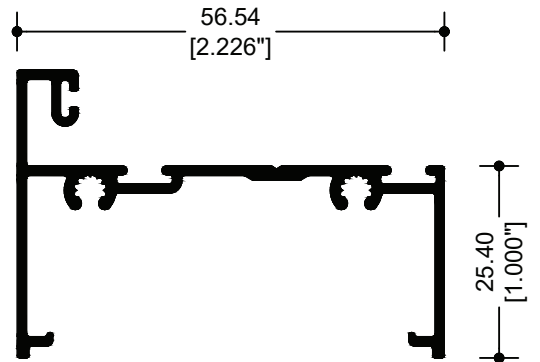
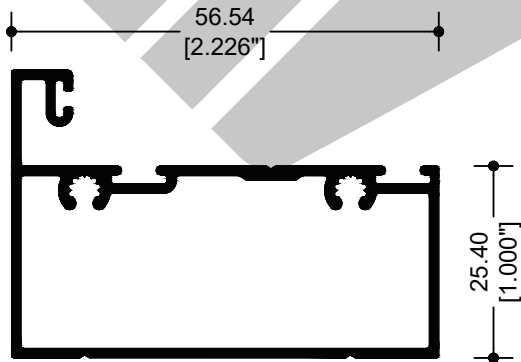
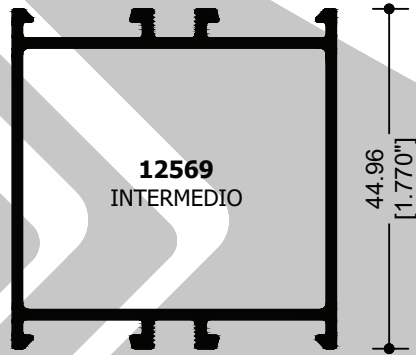

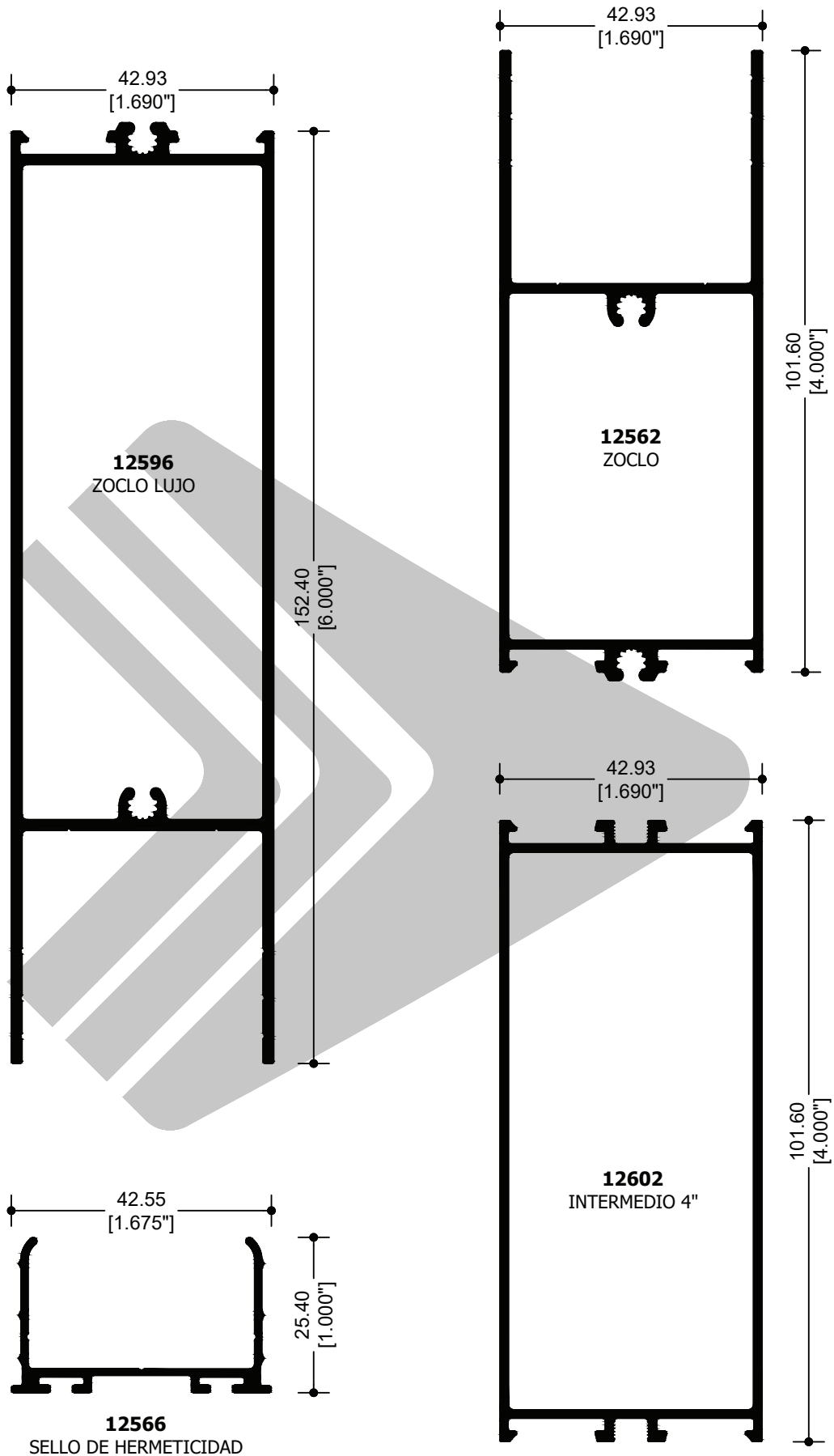

BATIENTE PUERTA

CLASSIC SERIE

S50

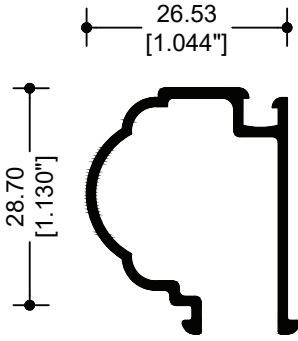

**12595**  
JUNQUILLO ALTO RELIEVE

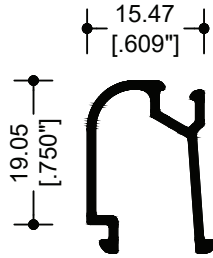

**12576**  
JUNQUILLO COLONIAL

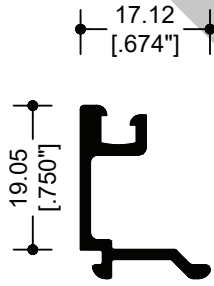

**12603**  
JUNQUILLO DOBLE VIDRIO  
18mm

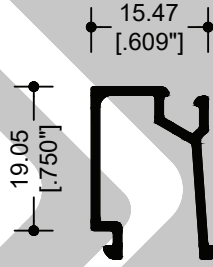

**12543**  
JUNQUILLO

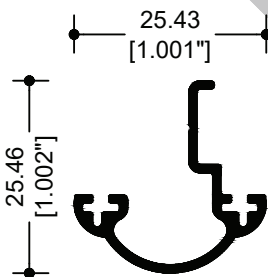

**12653**  
ADAPTADOR INTERMEDIO

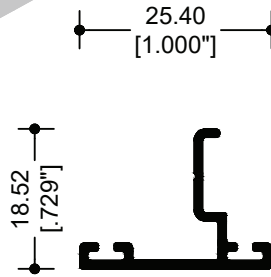

**74272**  
ADAPTADOR INTERMEDIO  
PLANO

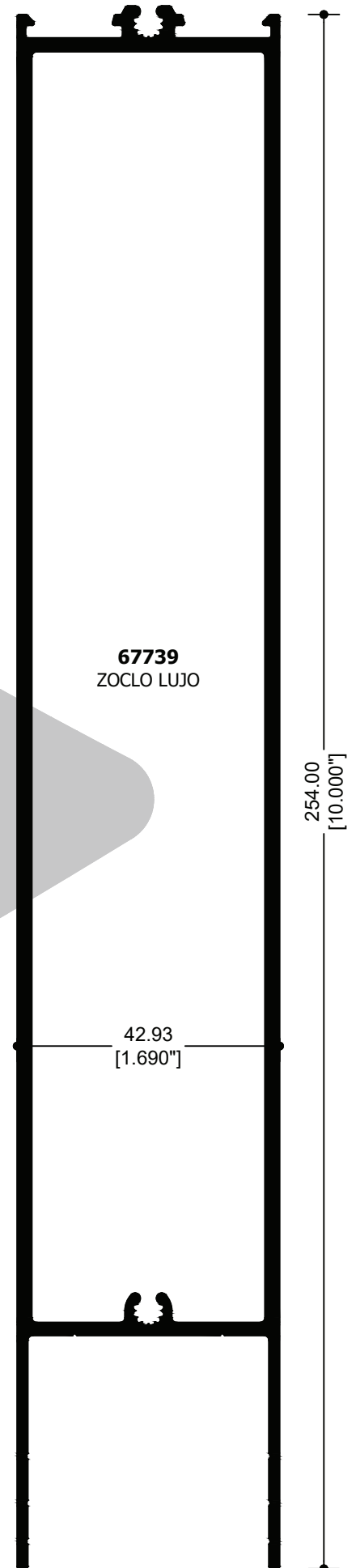

**67739**  
ZOCLO LUJO



CLASSIC

SERIE

S50



BATIENTE PUERTA

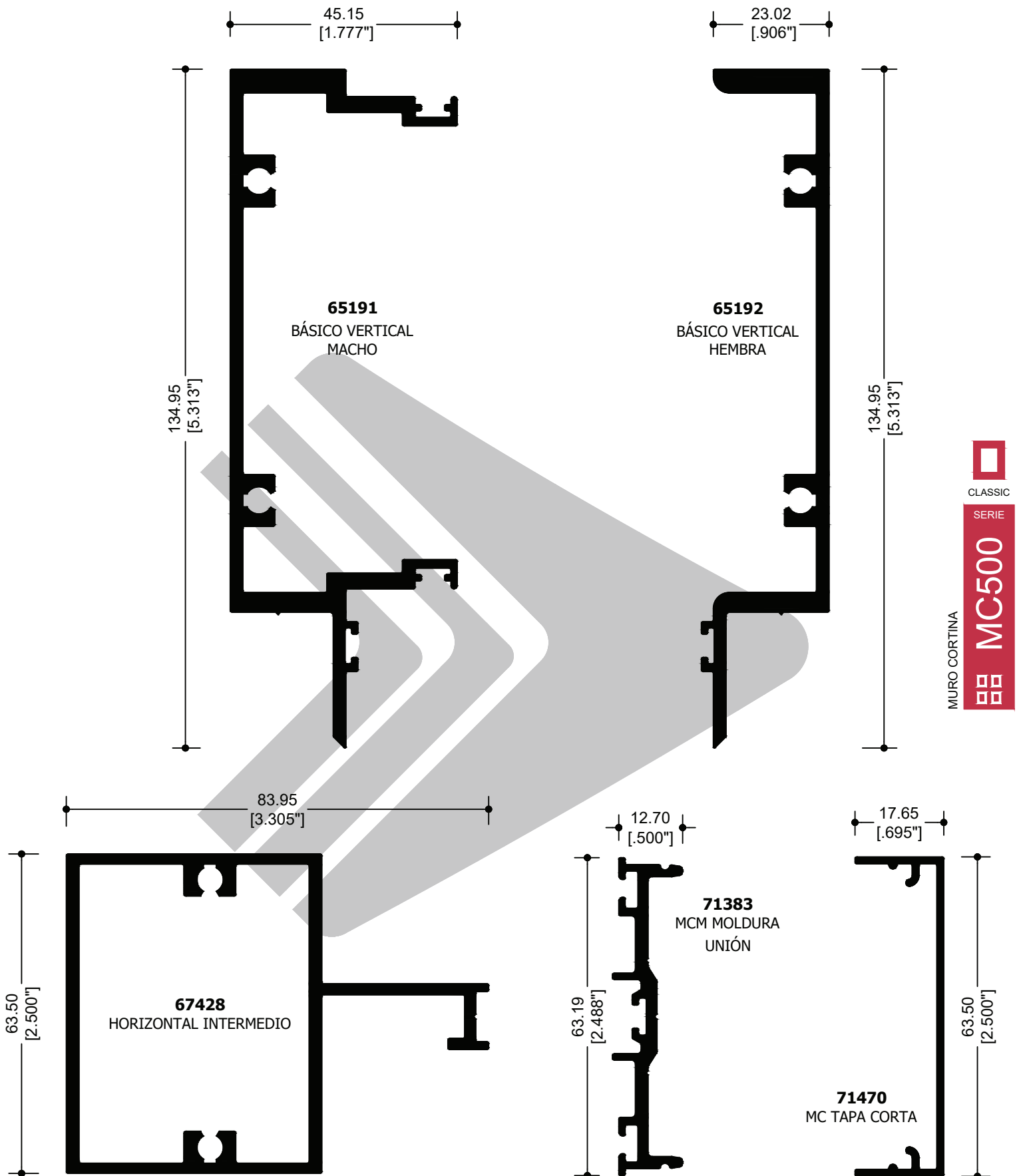

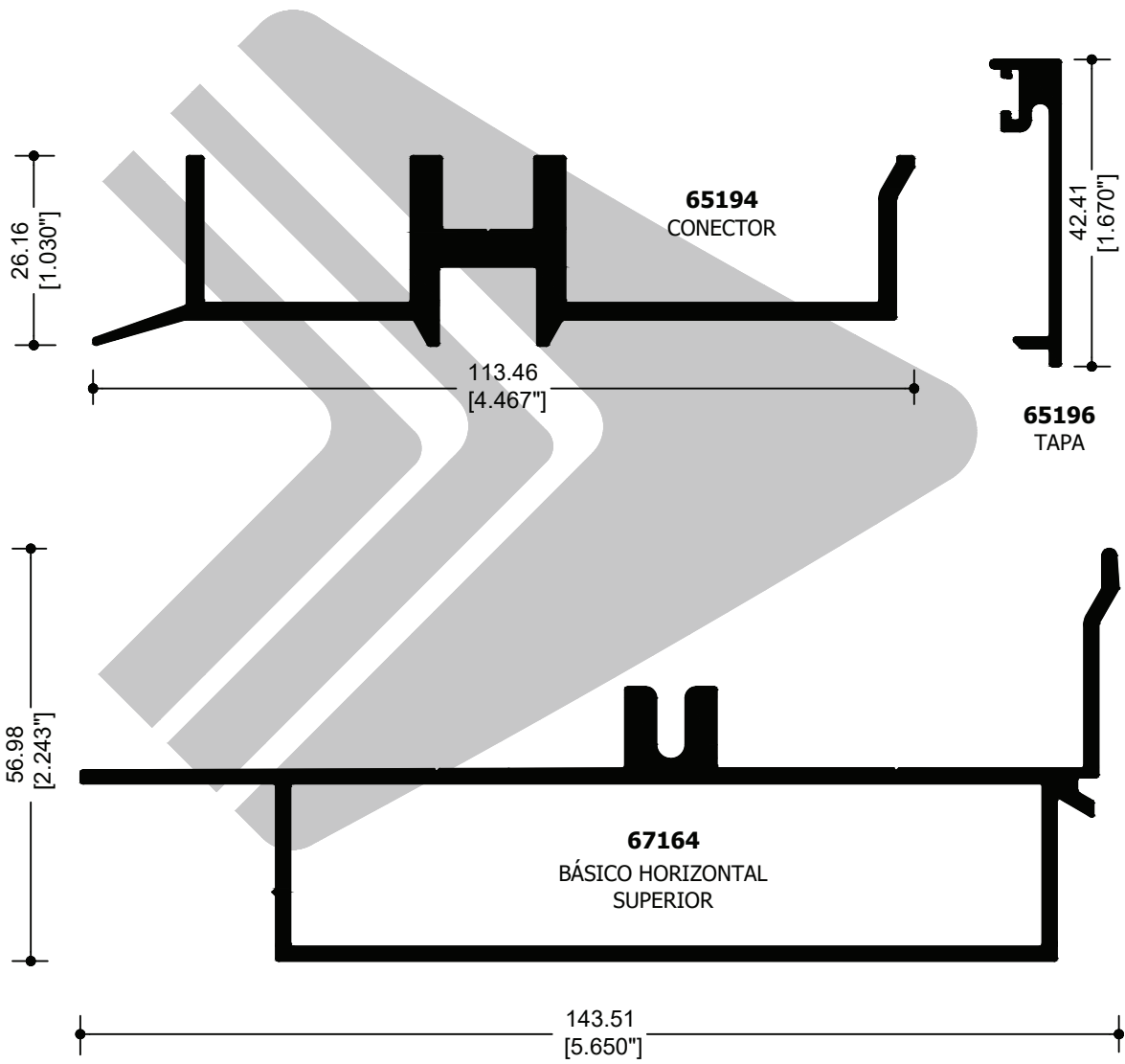
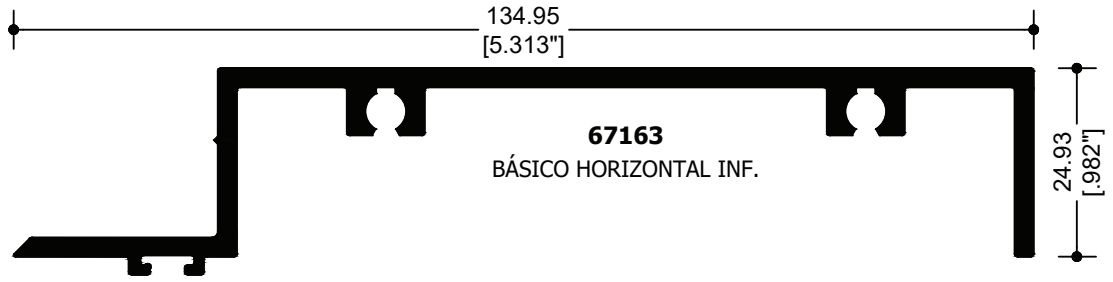

CLASSIC  
SERIE  
**MC500**  
MURO CORTINA



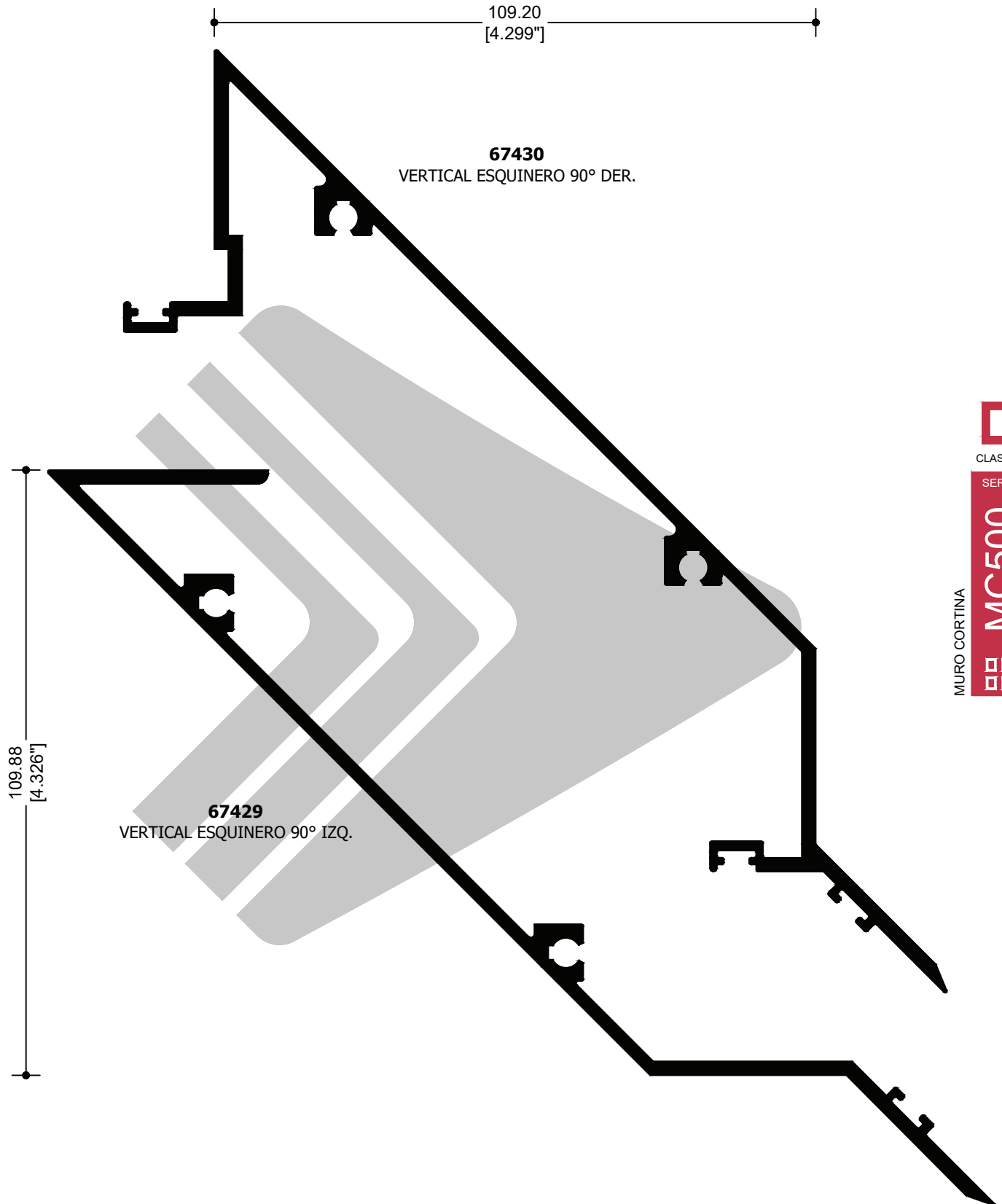



CUPRUM

A modern, bright bathroom with a large window overlooking a landscape with greenery and a blue sky with clouds. In the foreground, there is a white freestanding bathtub on the left and a white vanity with a round sink on the right. The floor is made of light-colored, polished tiles. The overall atmosphere is clean and airy.

**EUROVENT**   
P R E M I U M



CUPRUM

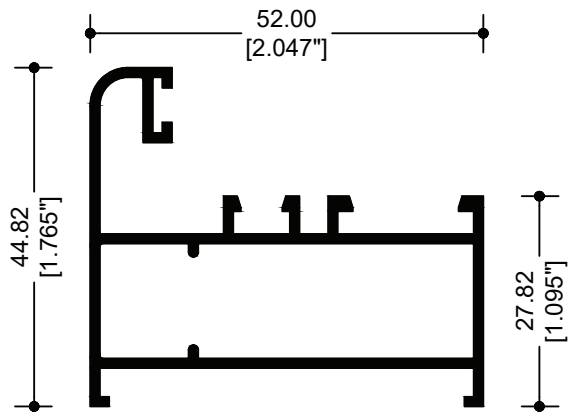

**62033**  
"L" CONTRAMARCO

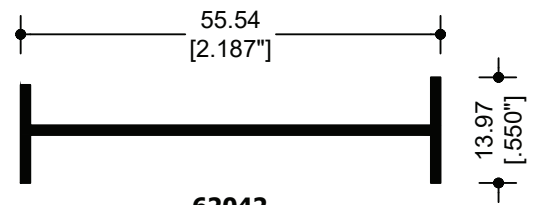

**62042**  
MOLDURA DE UNIÓN

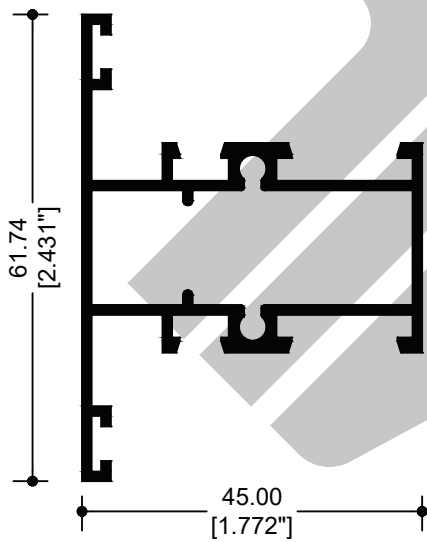

**62041**  
INTERMEDIO CUADRÍCULA

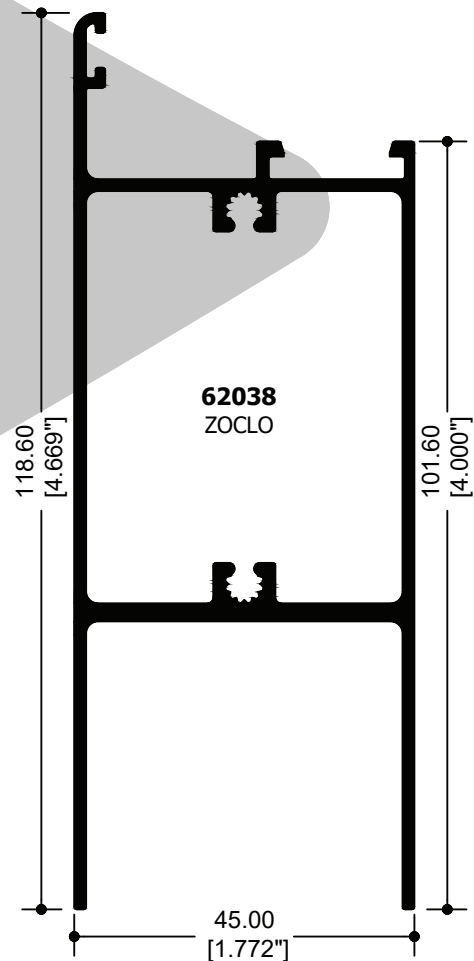

**62038**  
ZOCLO

  
 PREMIUM  
 SERIE  
**S45**  
 FIJO



PREMIUM  
SERIE

S45



FIJO

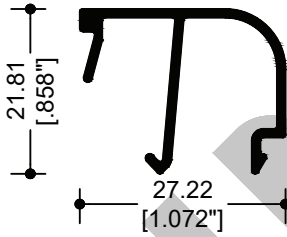

**82029**  
JUNQUILLO VIDRIO SENCILLO

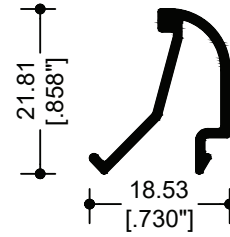

**82030**  
JUNQUILLO VIDRIO DOBLE

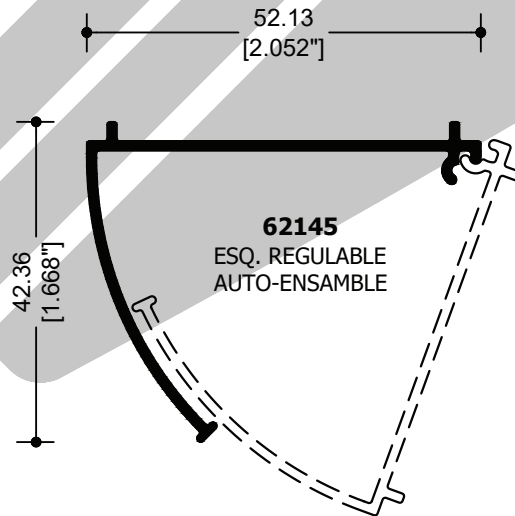

**62145**  
ESQ. REGULABLE  
AUTO-ENSAMBLE

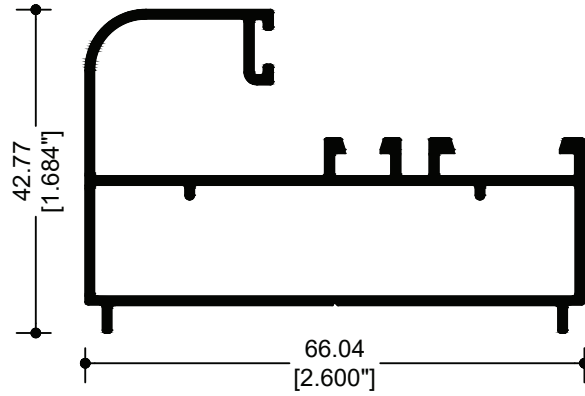

**82092**  
FIJO

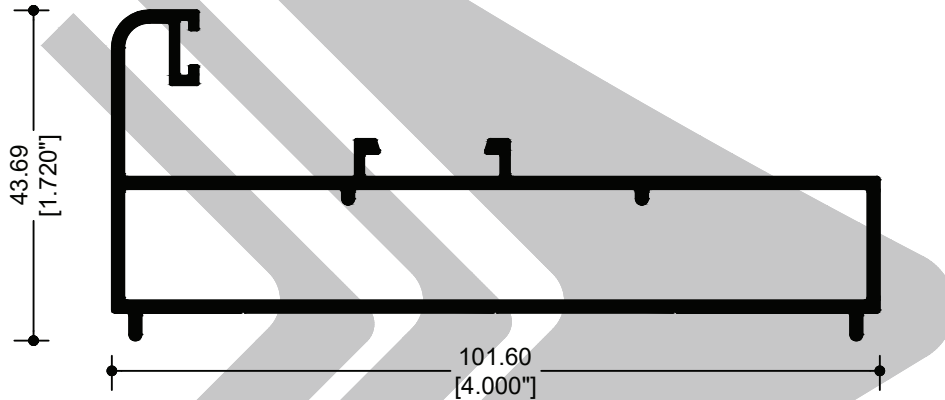

**87734**  
FIJO 4"

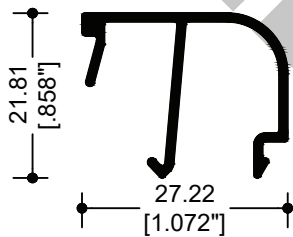

**82029**  
JUNQUILLO VIDRIO SENCILLO

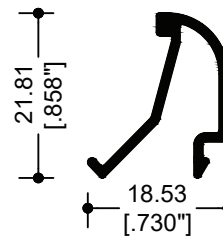

**82030**  
JUNQUILLO VIDRIO DOBLE

  
 PREMIUM  
 SERIE  
**S80**  
  
 FIJO



PREMIUM

SERIE

080



FIJO

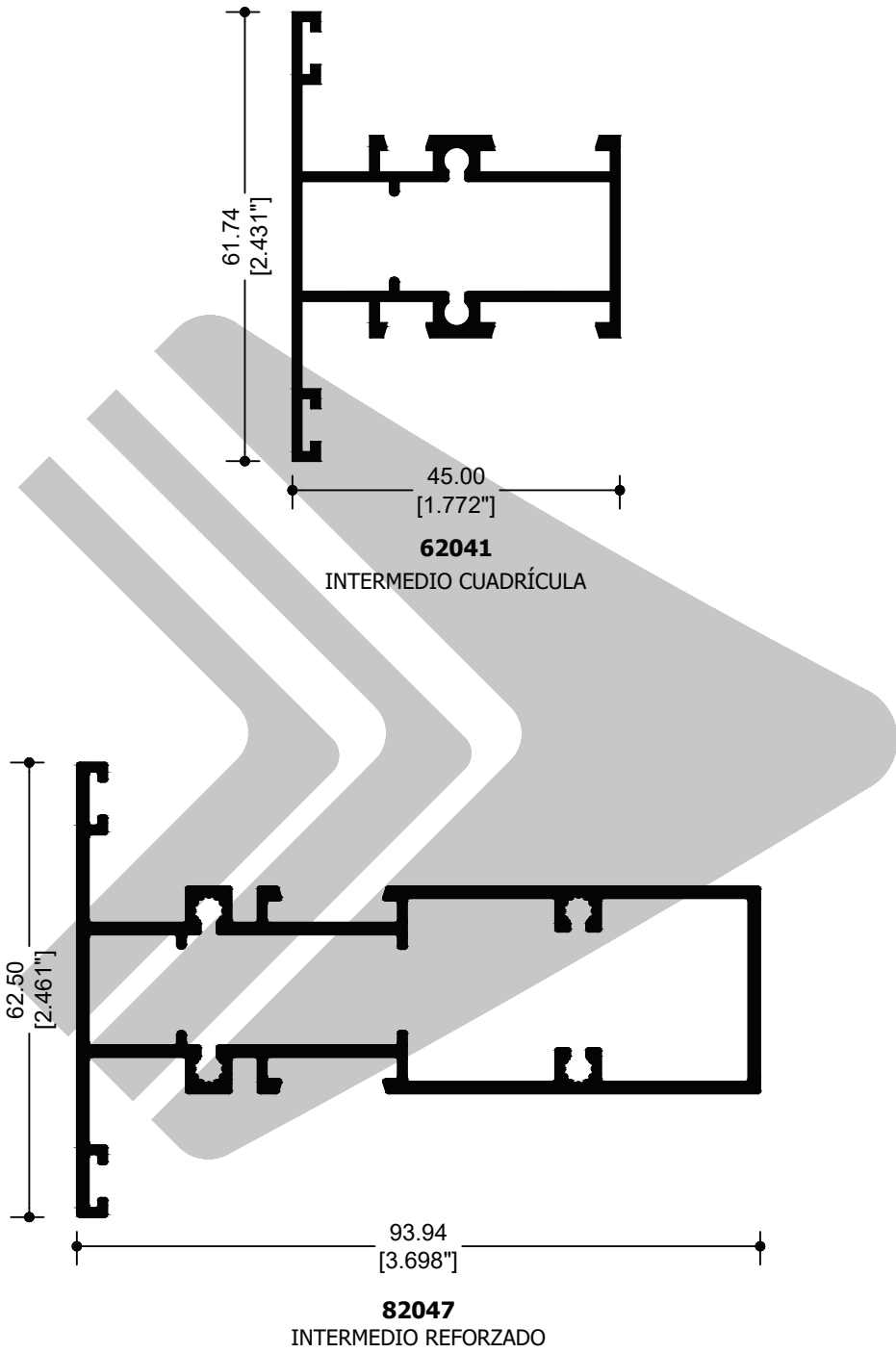



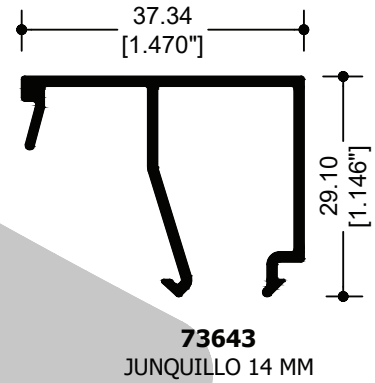
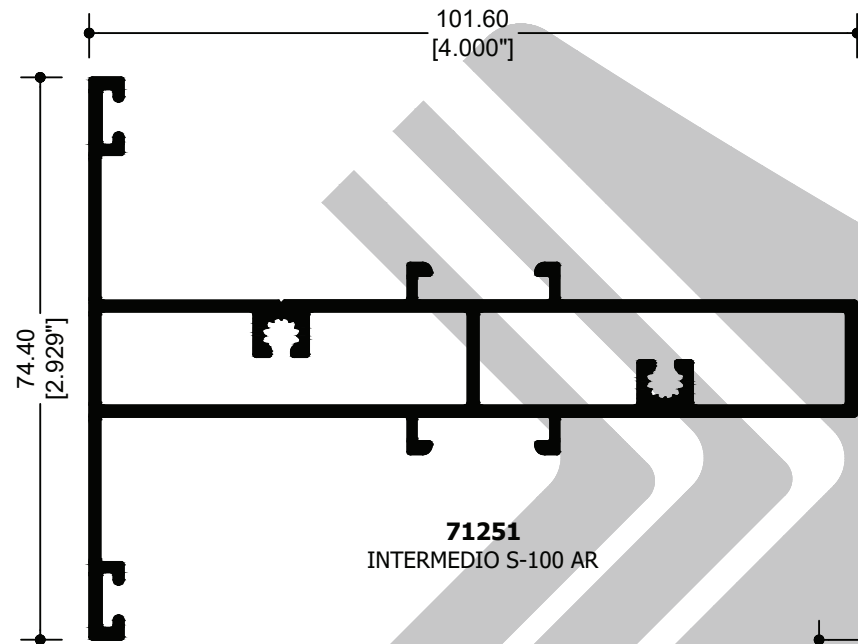
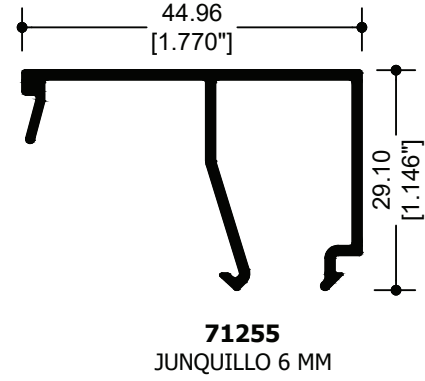
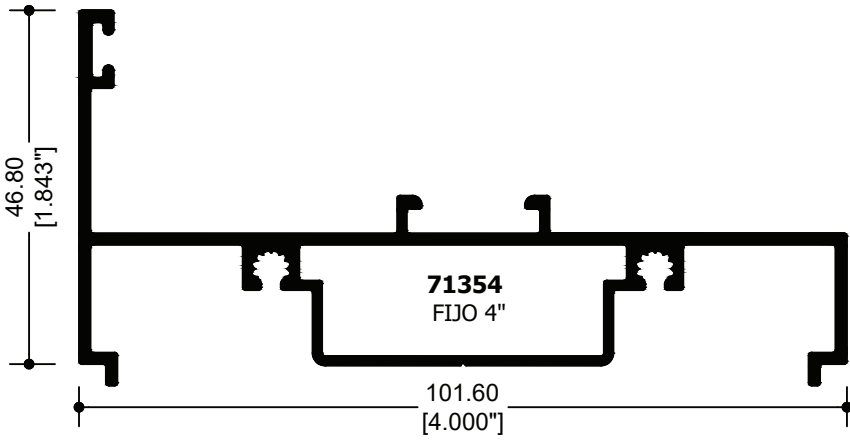

  
PREMIUM  
SERIE  
**S100AR**  
FIJO

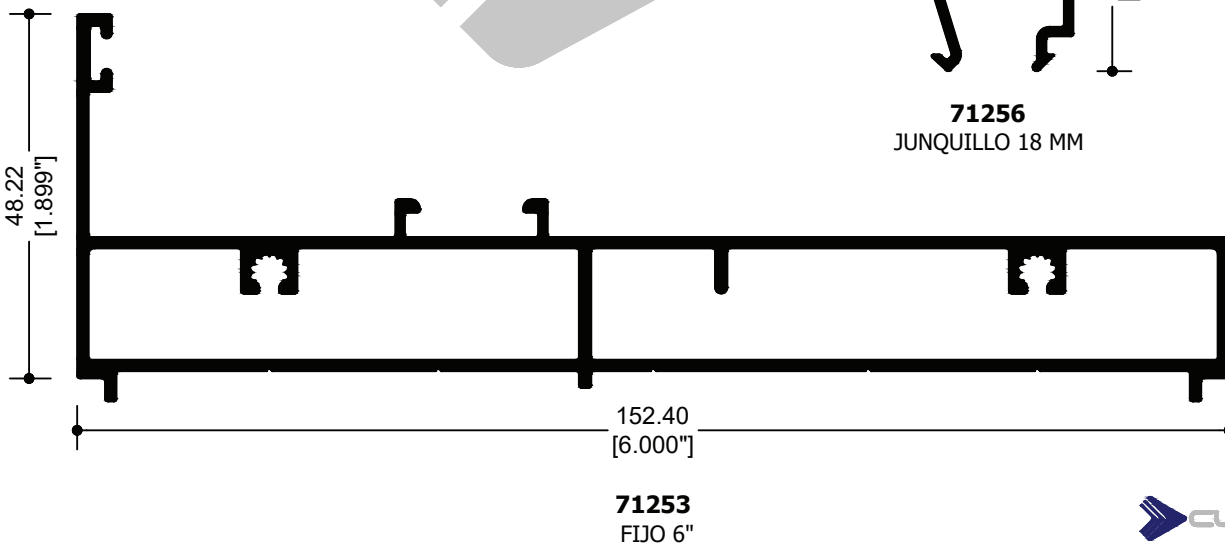
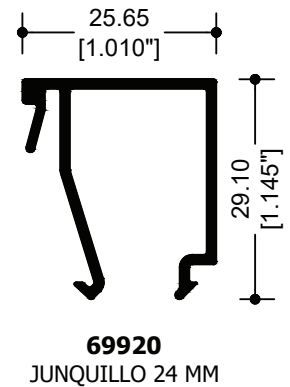
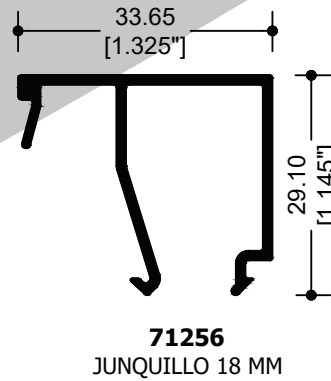

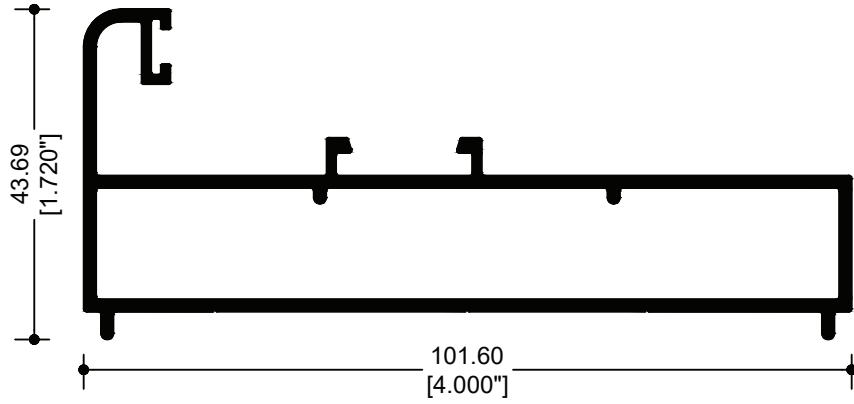

**87734**  
FIJO 4"

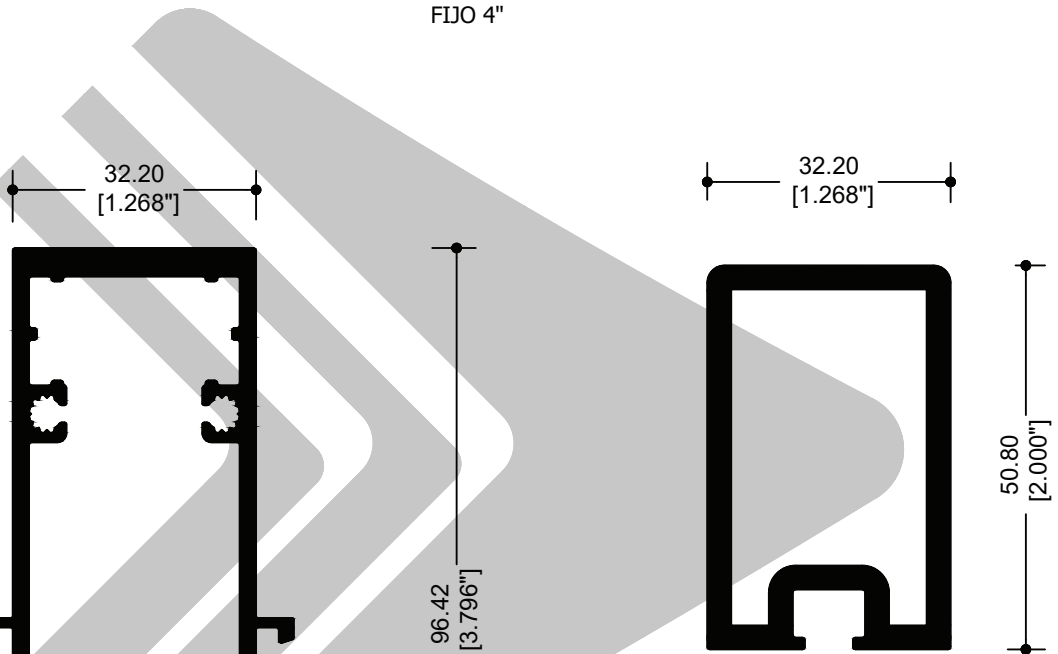

**67712**  
REFUERZO PARA  
INTERMEDIO

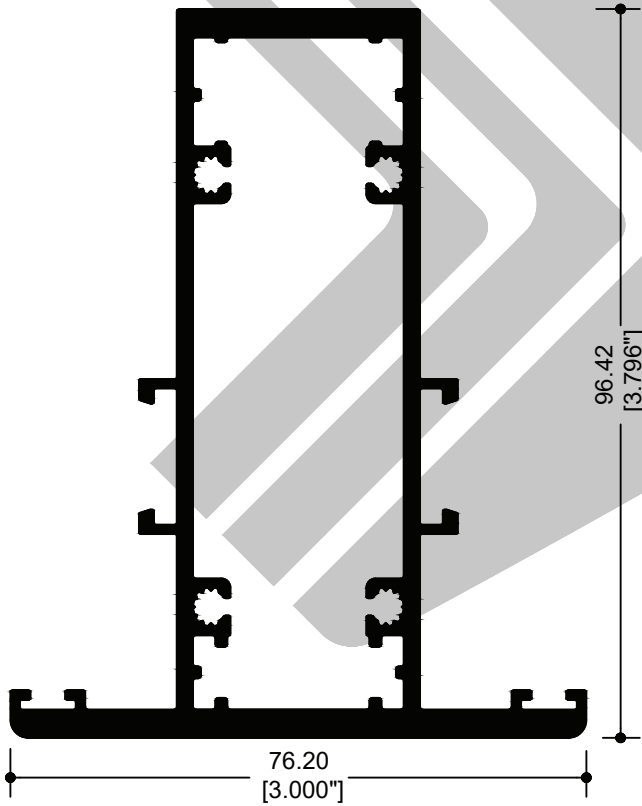

**87735**  
INTERMEDIO

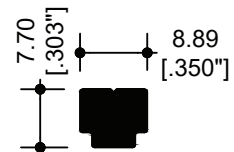

**14412**  
CONECTOR

PREMIUM  
SERIE  
**S150**  
FIJO

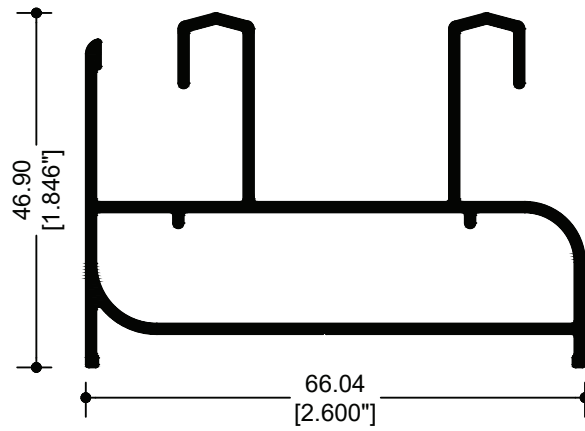

**82000**  
MARCO 2 VÍAS

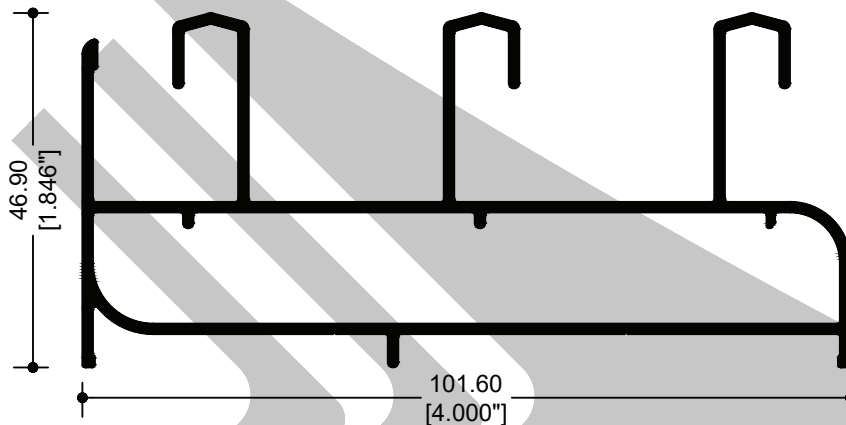

**82017**  
MARCO 3 VÍAS

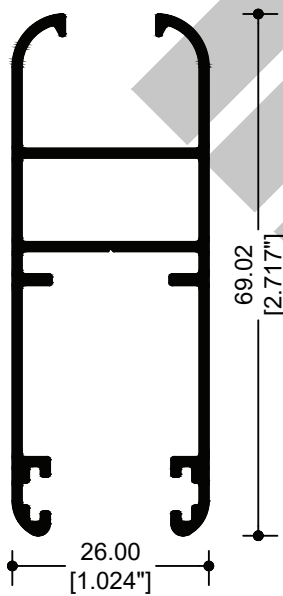

**82001**  
HOJA DE VIDRIO SENCILLO

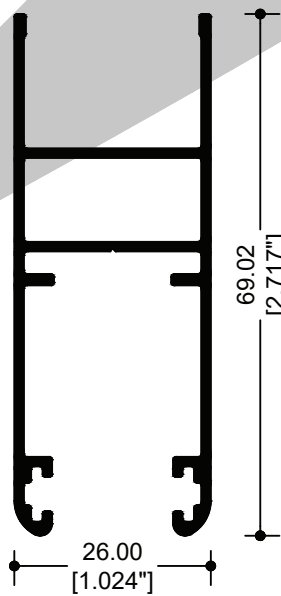

**82004**  
HOJA DE VIDRIO DOBLE

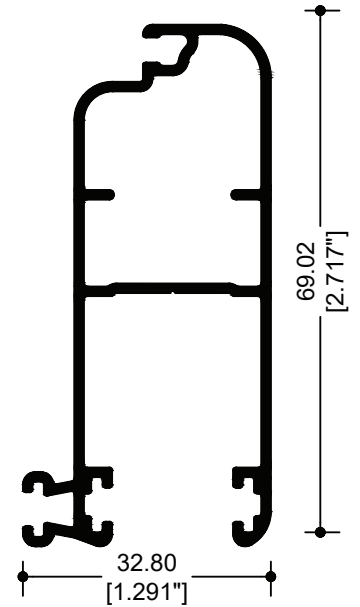

**82019**  
MOSQUITERO



PREMIUM

SERIE

S80



CORREDIZA

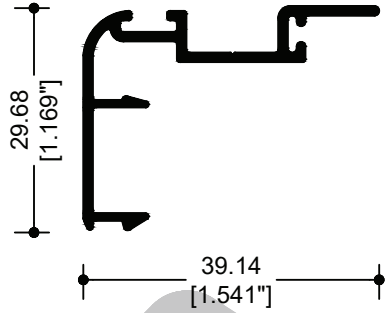

**82002**  
TRASLAPE

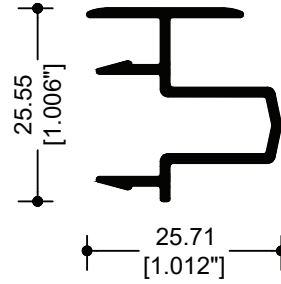

**82103**  
ADAPTADOR OXXO

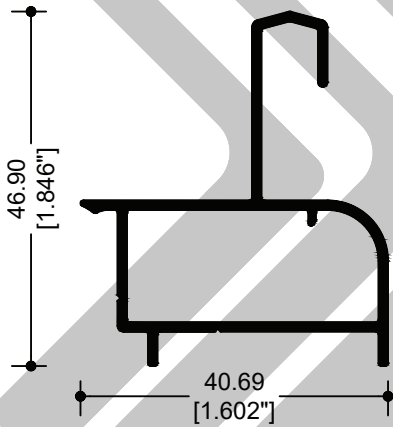

**84207**  
PISTA ADICIONAL

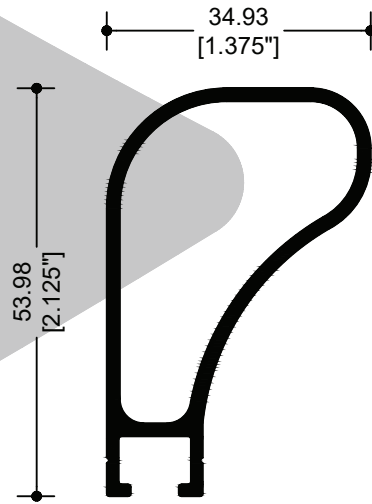

**62014**  
REFUERZO

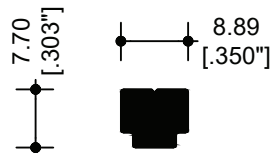

**14412**  
CONECTOR

PREMIUM  
SERIE  
**S80**  
CORREDIZA

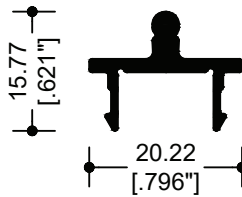
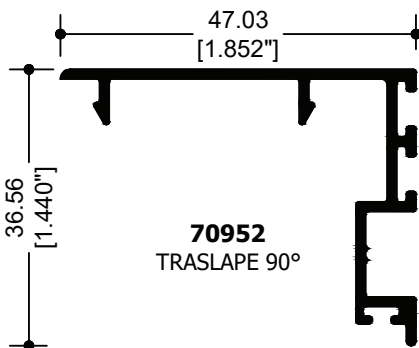
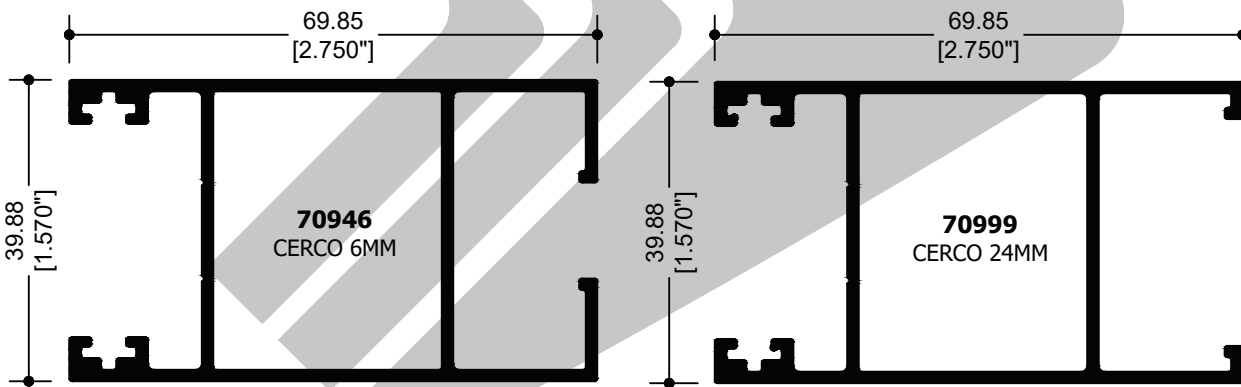
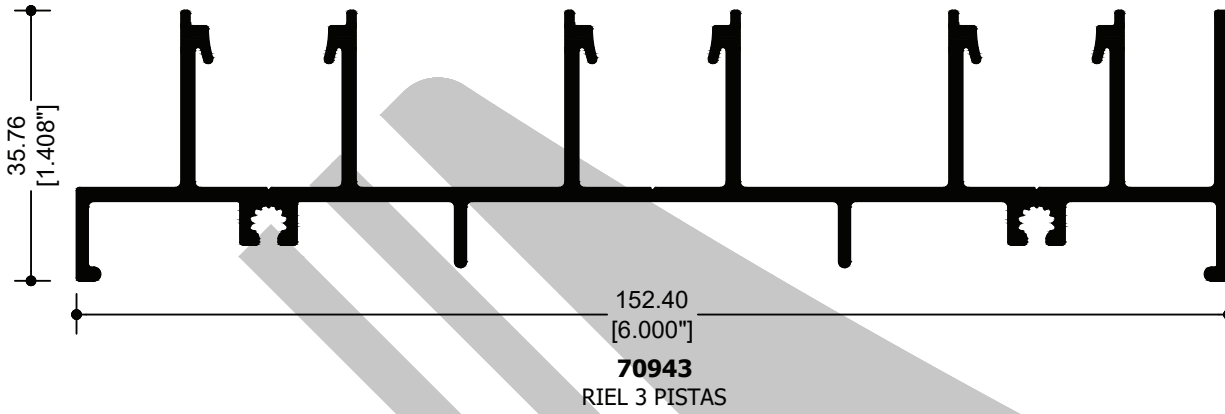
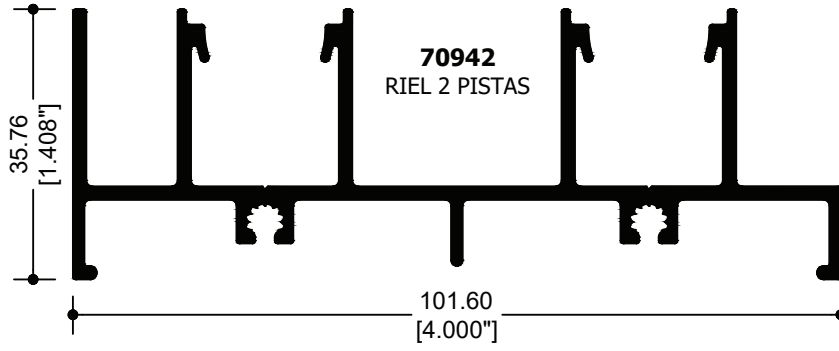

**72609**  
PISTA DE GOTA

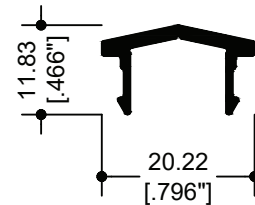

**70944**  
PISTA 2 AGUAS

CORREDIZA

PREMIUM

SERIE

**S100AR**

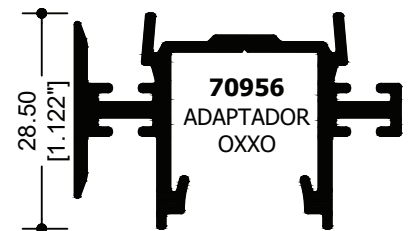
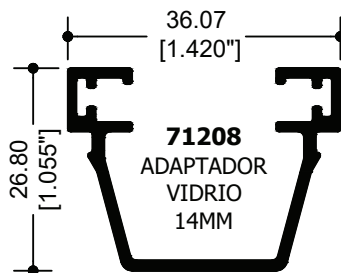
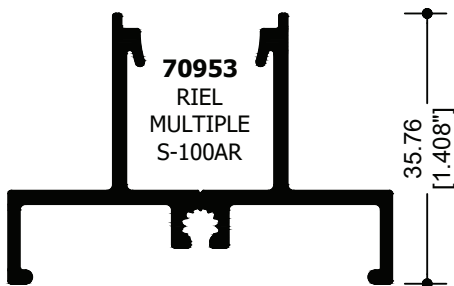
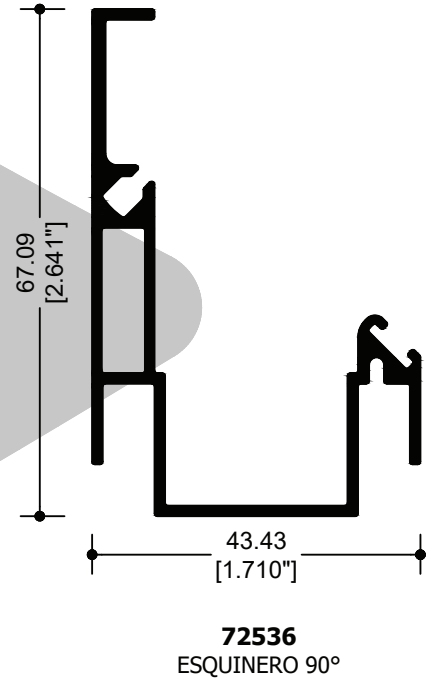
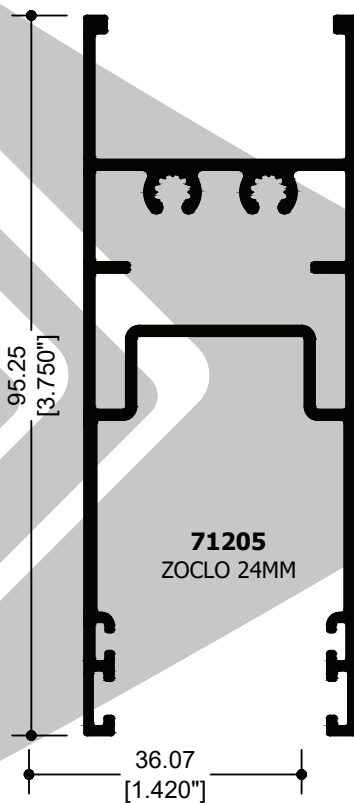
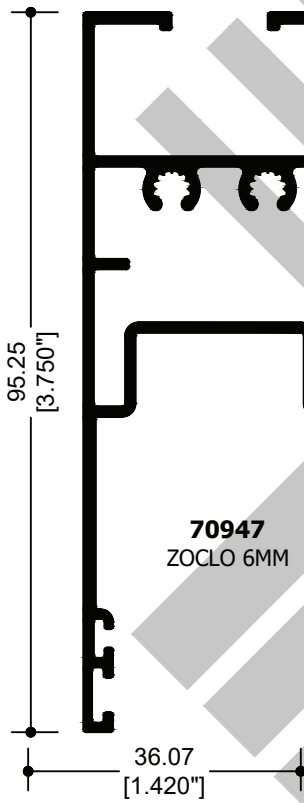
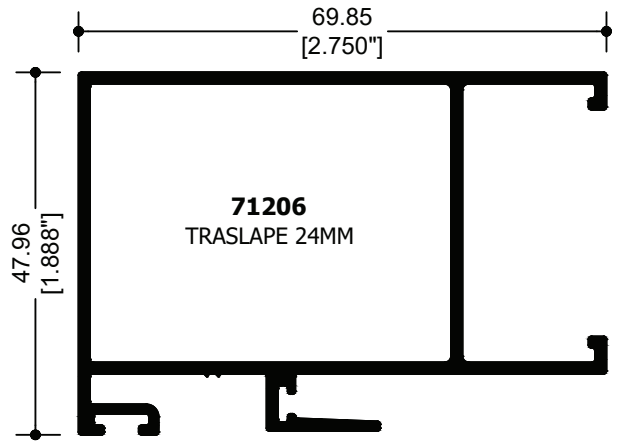
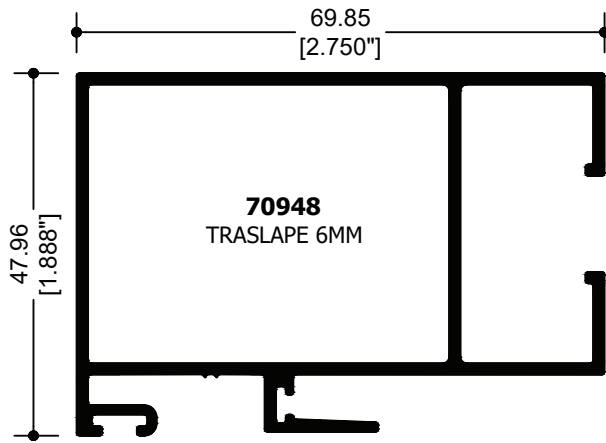

PREMIUM  
SERIE  
S100AR  
CORREDIZA

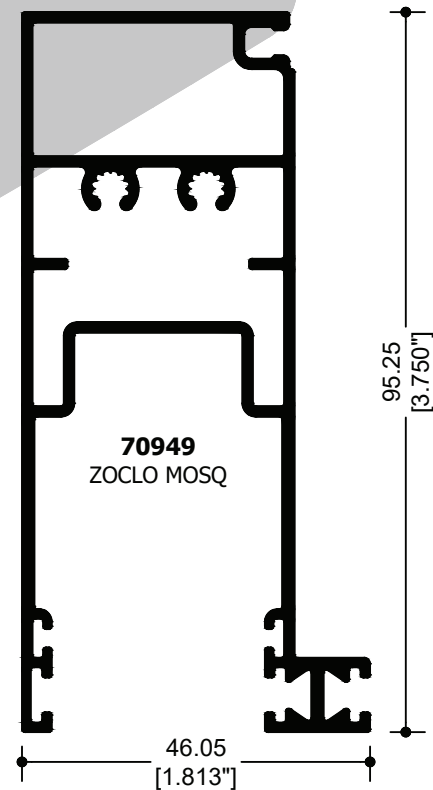
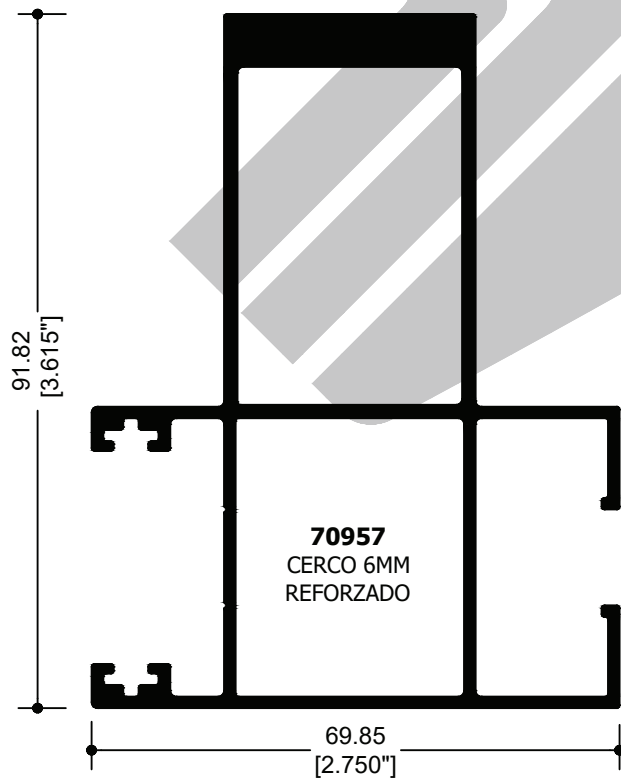
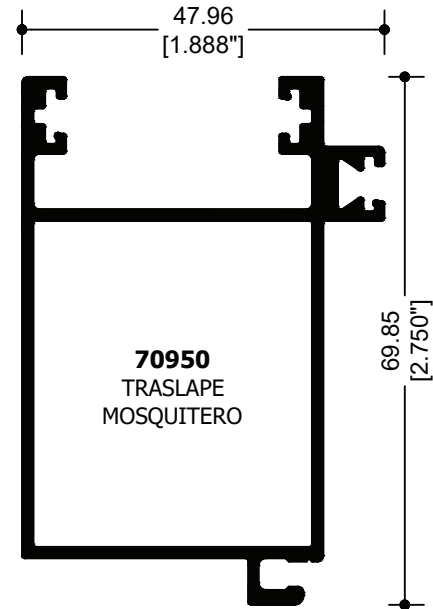
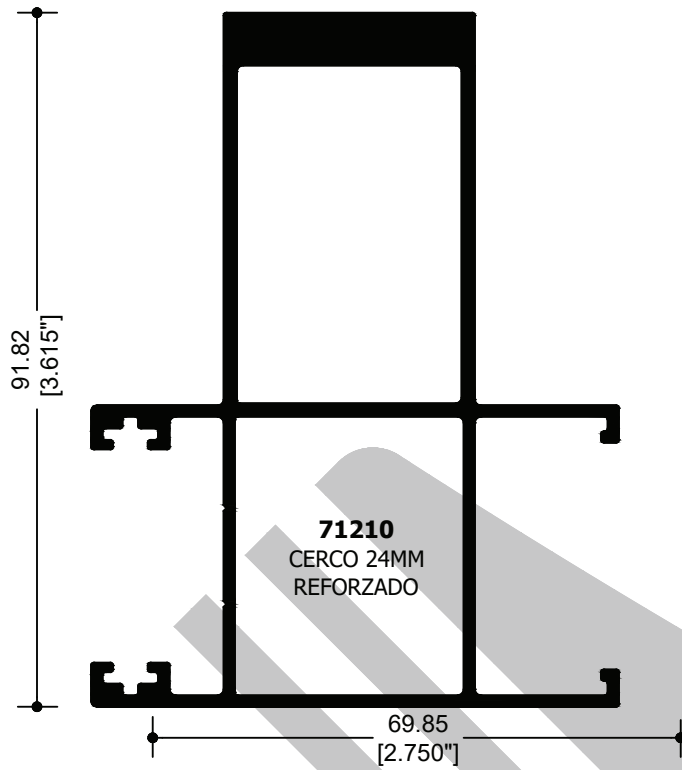

CORREDIZA

 PREMIUM

SERIE

 S100AR

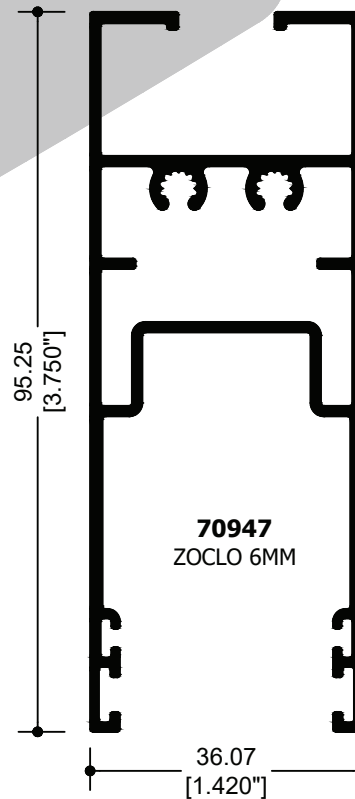
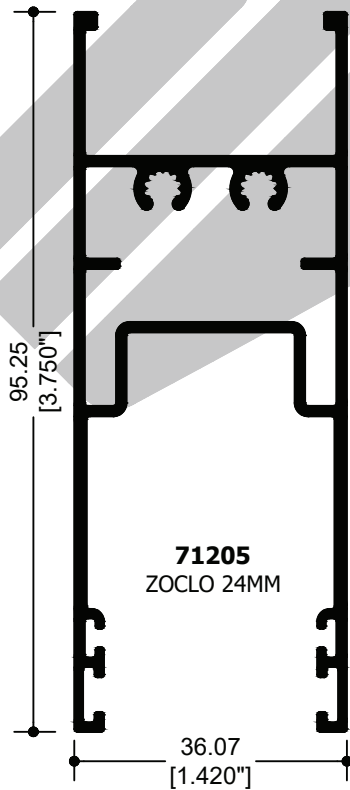
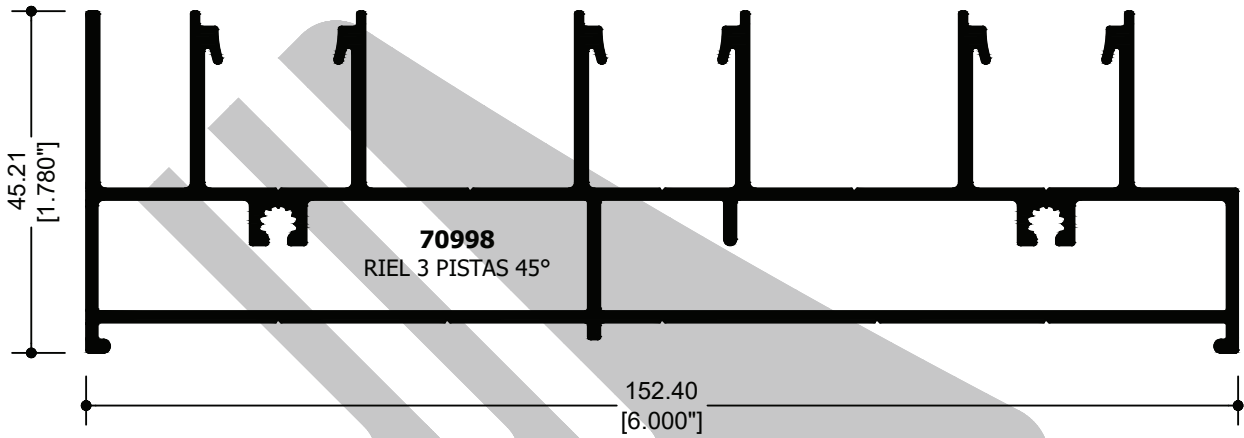
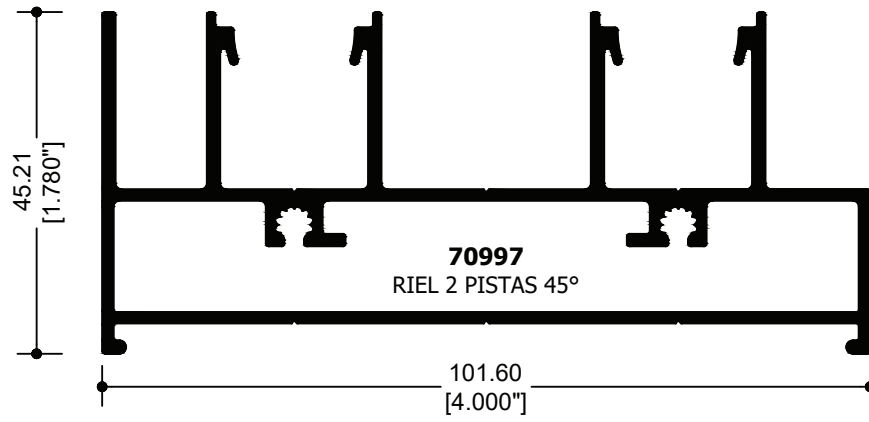

PREMIUM  
SERIE  
S100AR  
CORREDIZA



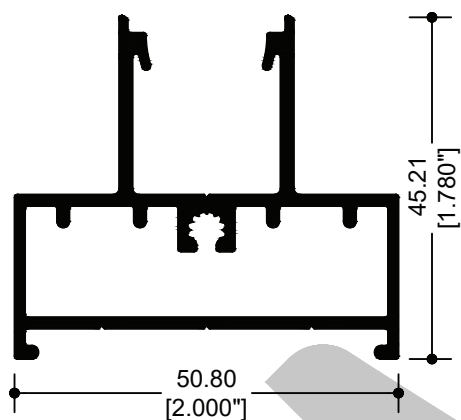

**71207**  
RIEL MÚLTIPLE 45°

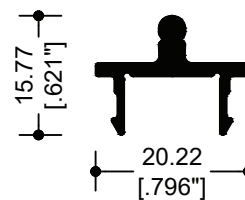

**72609**  
PISTA DE GOTA

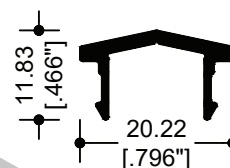

**70944**  
PISTA 2 AGUAS

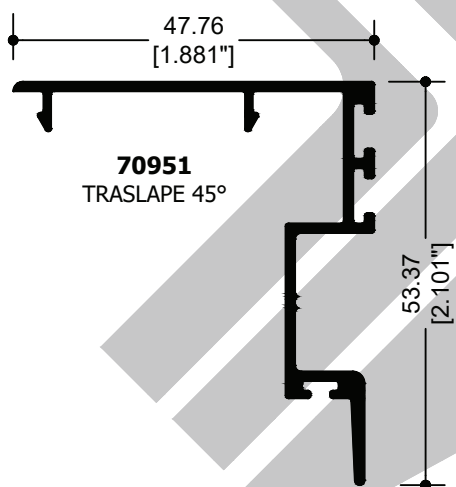

**70951**  
TRASLAPE 45°

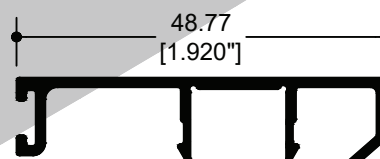

**70954**  
TAPA VISTA

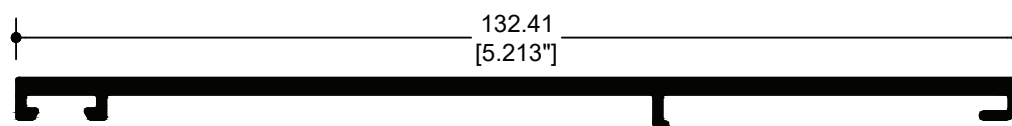

**71209**  
CHAMBRANA

CORREDIZA

PREMIUM  
SERIE

**S100AR**

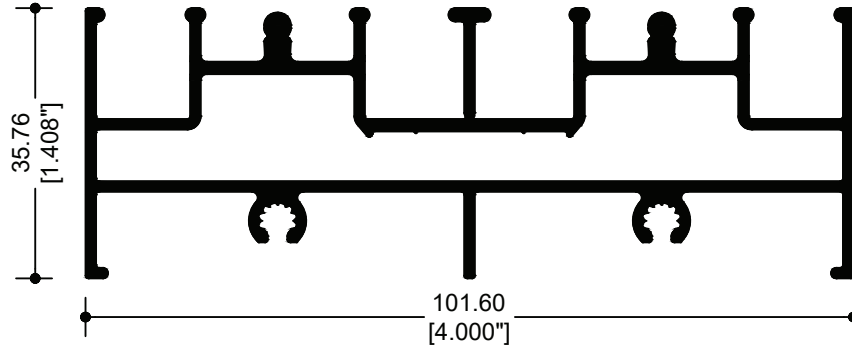

**72607**  
RIEL EMBUTIDO DOBLE

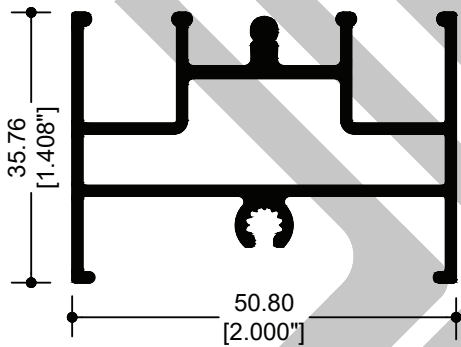

**72608**  
RIEL EMBUTIDO MÚLTIPLE

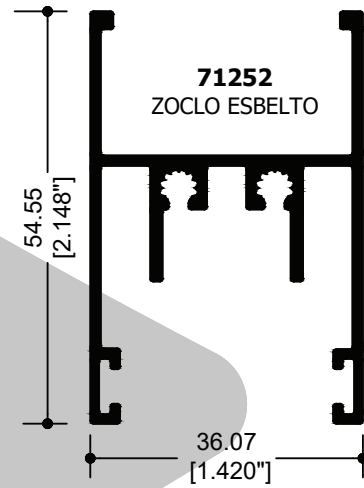

**71252**  
ZOCLO ESBELTO

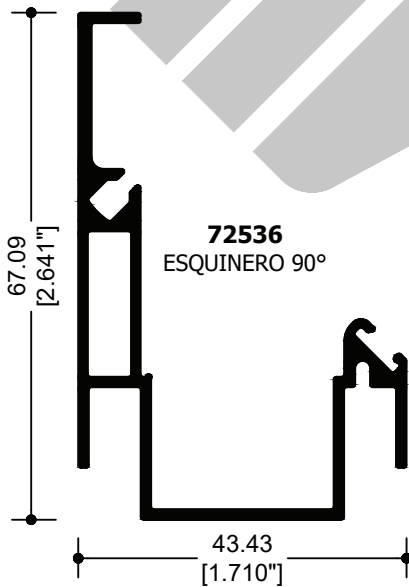

**72536**  
ESQUINERO 90°

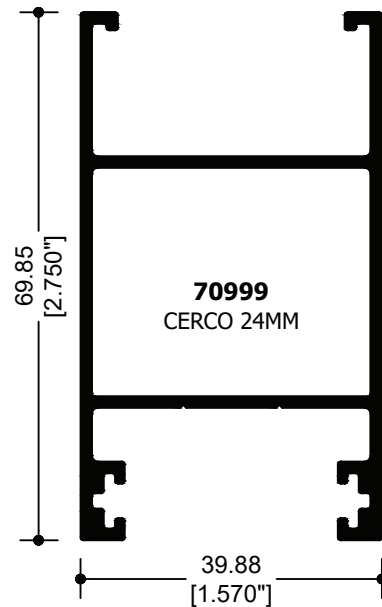

**70999**  
CERCO 24MM

PREMIUM  
SERIE  
**S100AR**  
CORREDIZA

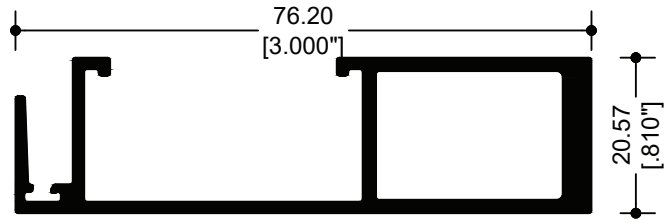

**72535**  
TRASLAPE PANORÁMICO 3"

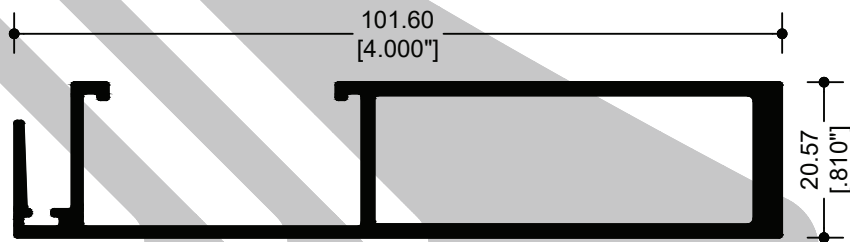

**72610**  
TRASLAPE PANORÁMICO 4"

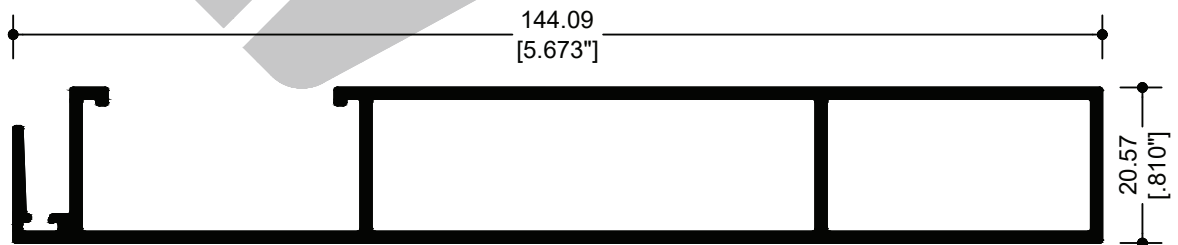

**71254**  
TRASLAPE ESBELTO



PREMIUM

SERIE

S100AR



CORREDIZA

PREMIUM  
SERIE  
**S150**  
CORREDIZA

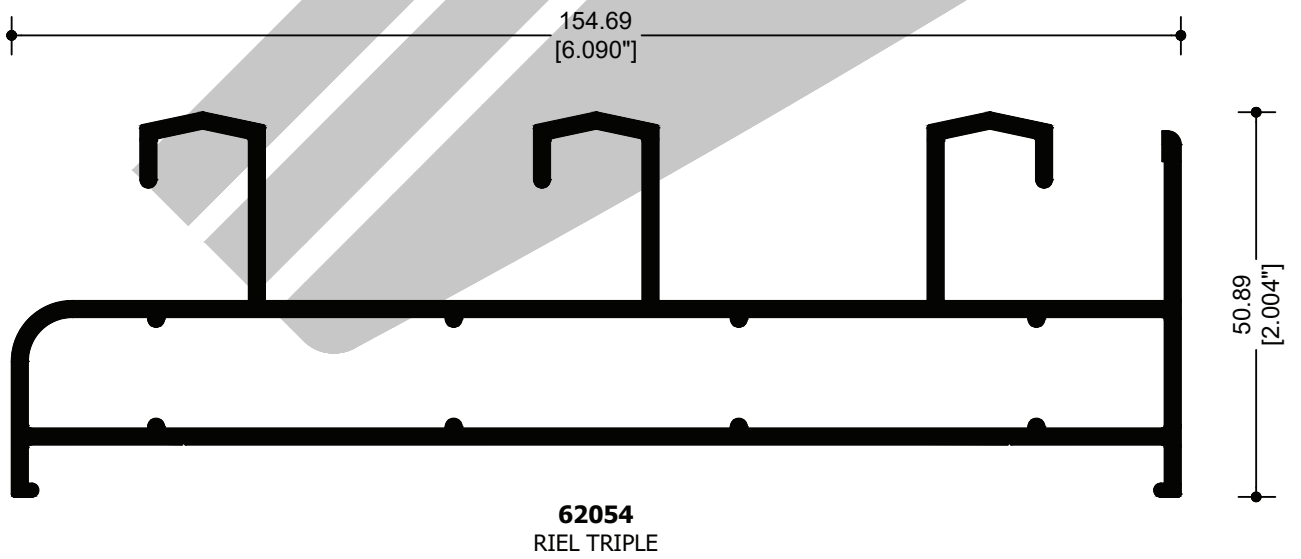
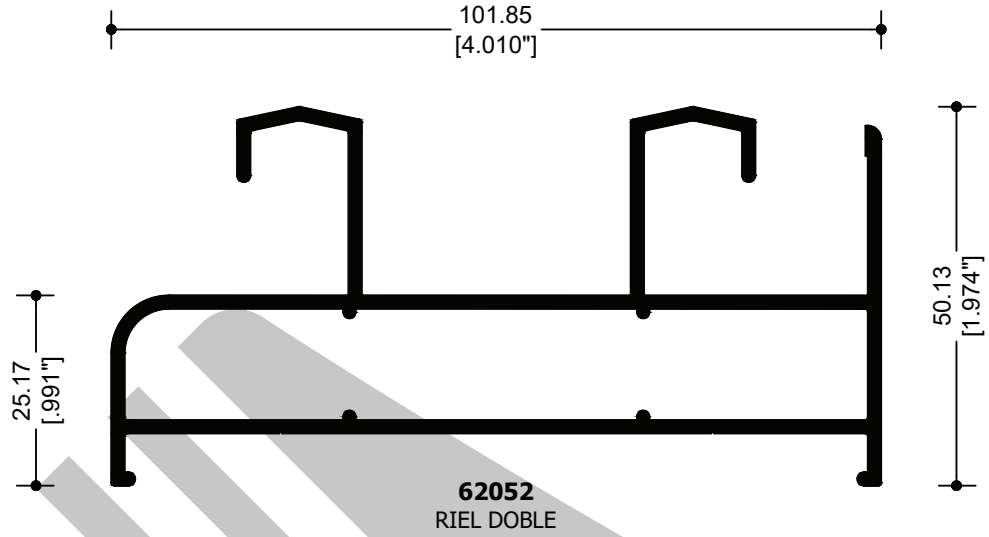

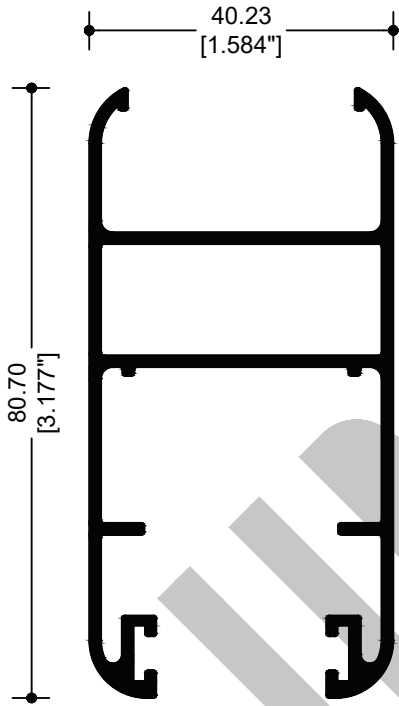

**62056**  
CERCO DOBLE VIDRIO 24mm

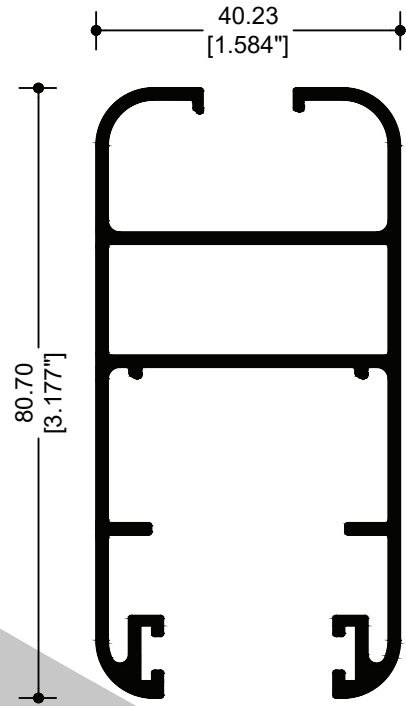

**62055**  
CERCO 6mm

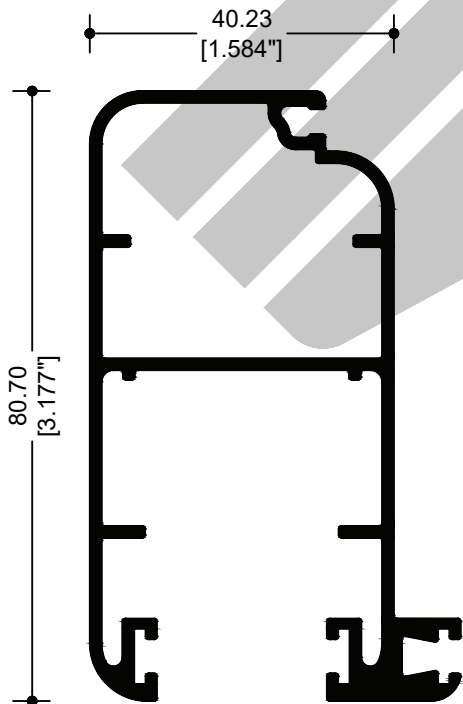

**62057**  
MOSQUITERO

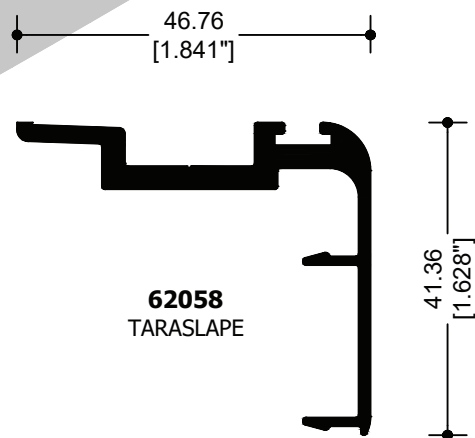

**62058**  
TARASLAPE

CORREDIZA

PREMIUM  
SERIE

**S150**

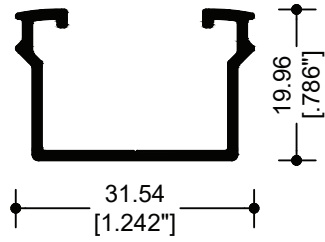

**62060**  
ADAPTADOR CRISTAL 9mm.

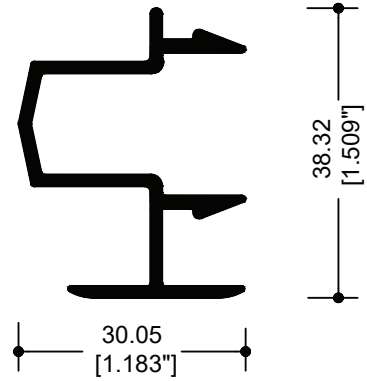

**64206**  
ADAPTADOR OXXO

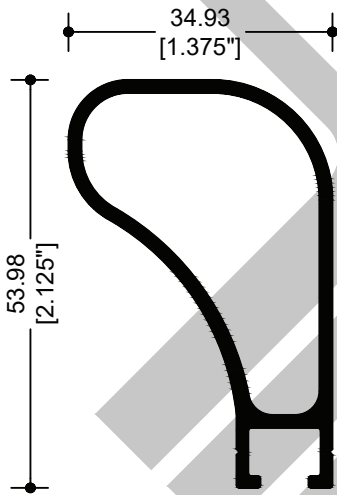

**62014**  
REFUERZO

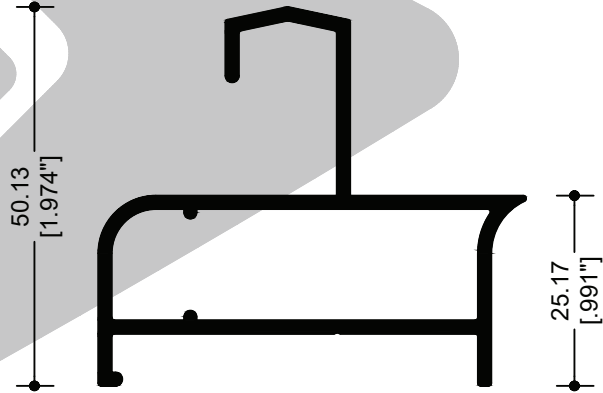

**62091**  
ADAPTADOR RIEL

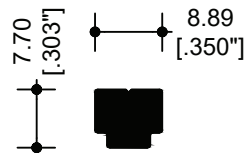

**14412**  
CONECTOR

PREMIUM  
SERIE  
**S150**  
CORREDIZA

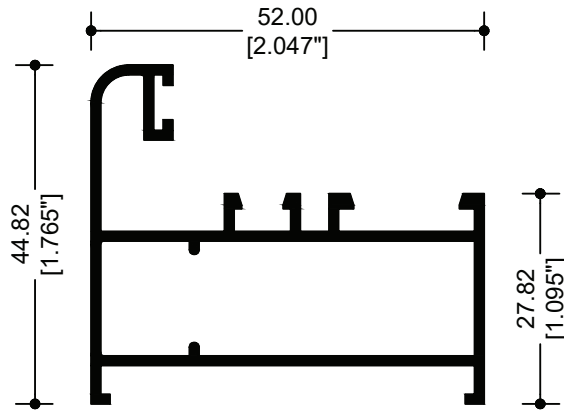

**62033**  
"L" CONTRAMARCO

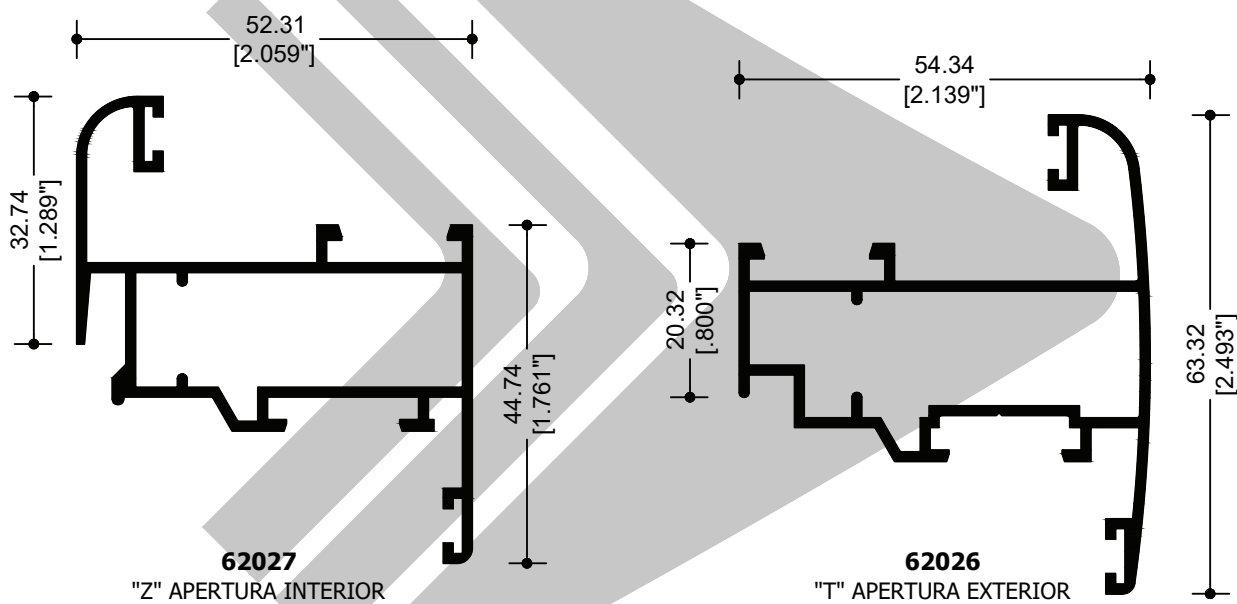

**62027**  
"Z" APERTURA INTERIOR

**62026**  
"T" APERTURA EXTERIOR

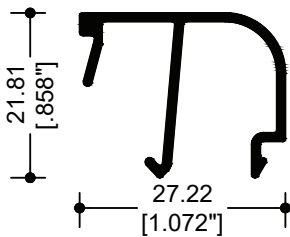

**82029**  
JUNQUILLO VIDRIO SENCILLO

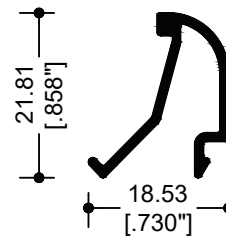

**82030**  
JUNQUILLO VIDRIO DOBLE



PREMIUM  
SERIE  
**S45**  
VENTANA BATIENTE

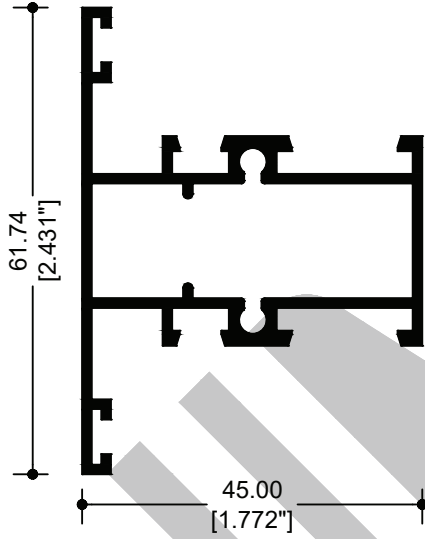

**62041**  
INTERMEDIO CUADRÍCULA

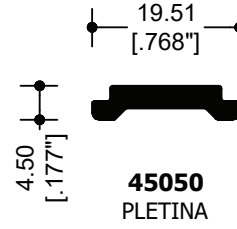

**45050**  
PLETINA

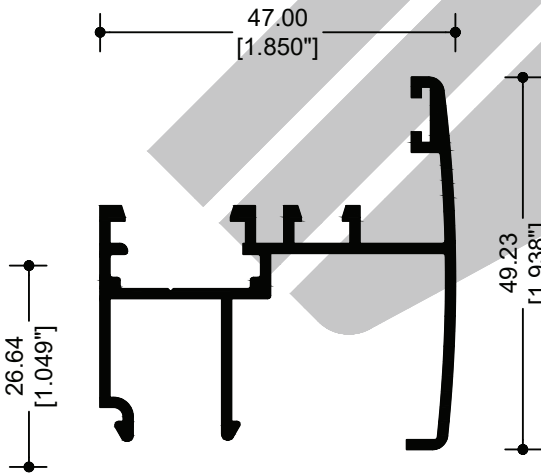

**62031**  
INTERMEDIO MOVIL

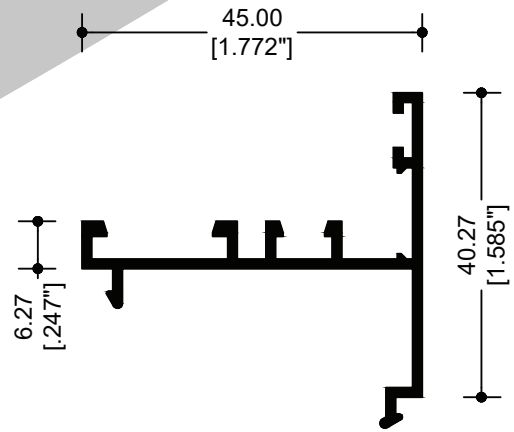

**62032**  
CONVERTIDOR



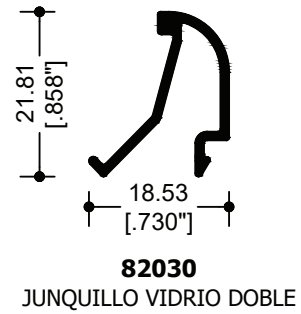
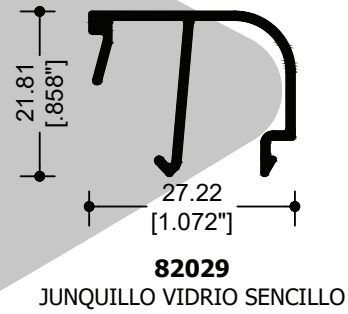
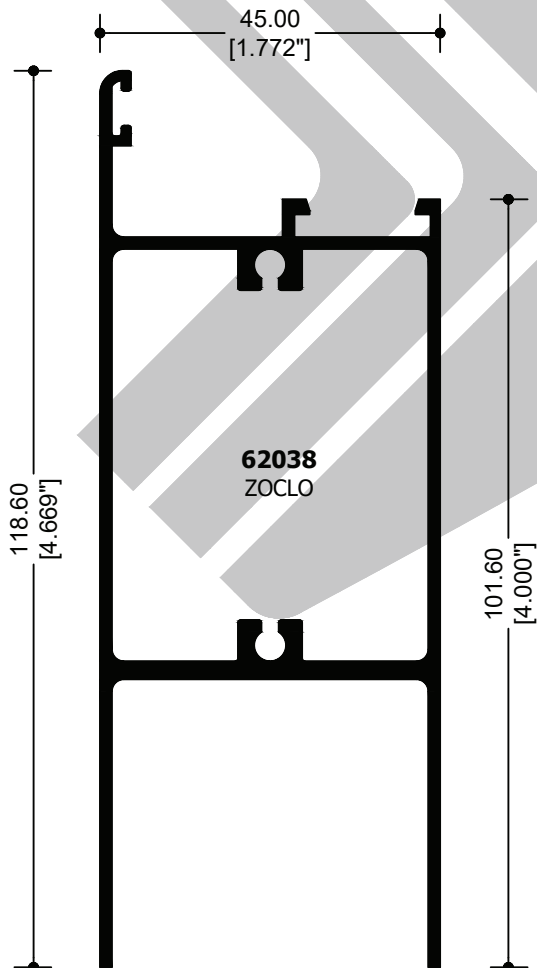
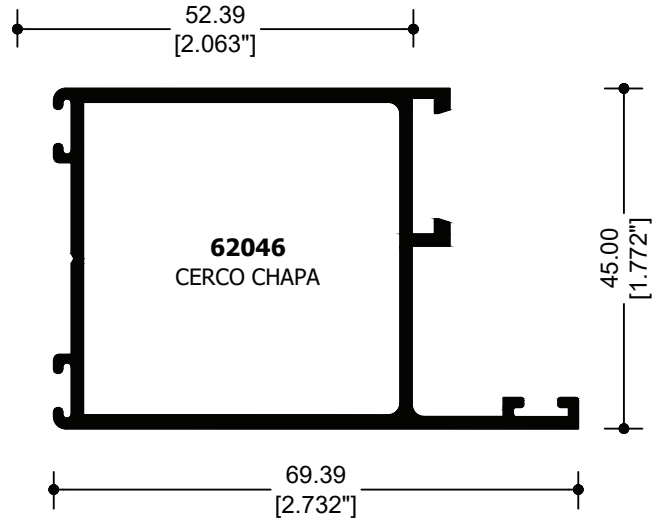
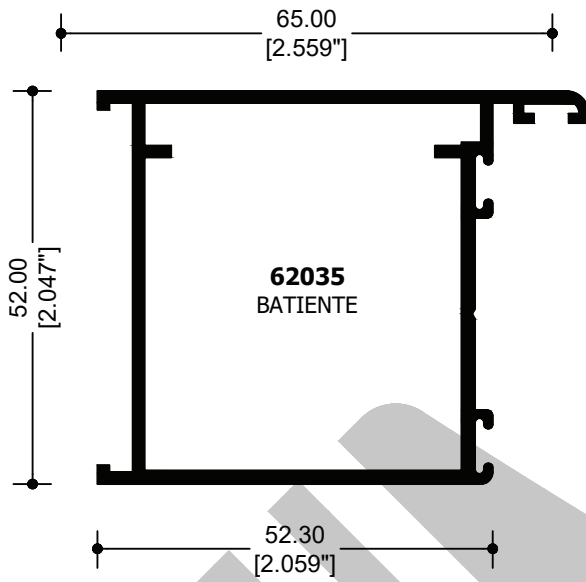

PREMIUM

SERIE

S45



BATIENTE PUERTA

PREMIUM  
SERIE  
**S45**  
BATEANTE PUERTA

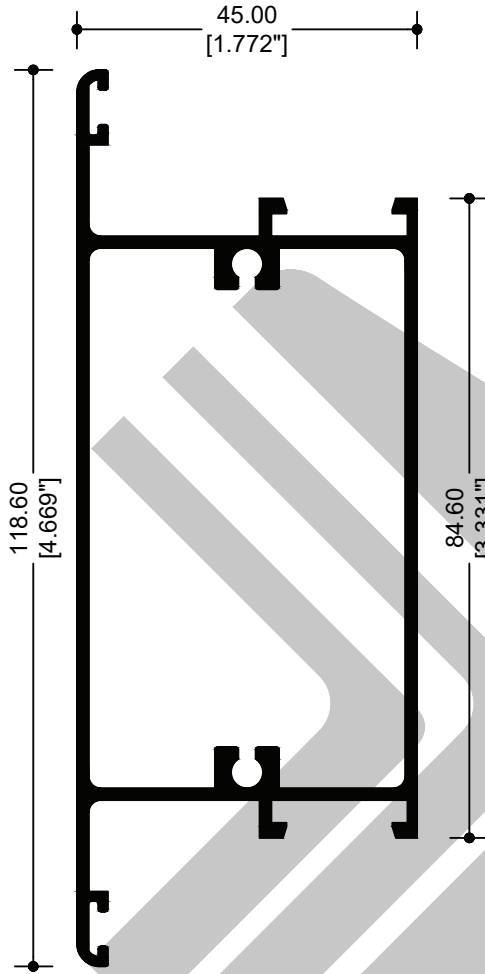

**62039**  
INTERMEDIO

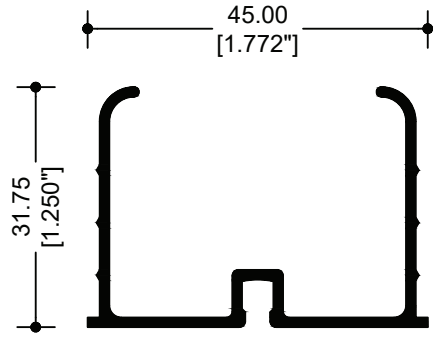

**62040**  
SELLO DE HERMETICIDAD

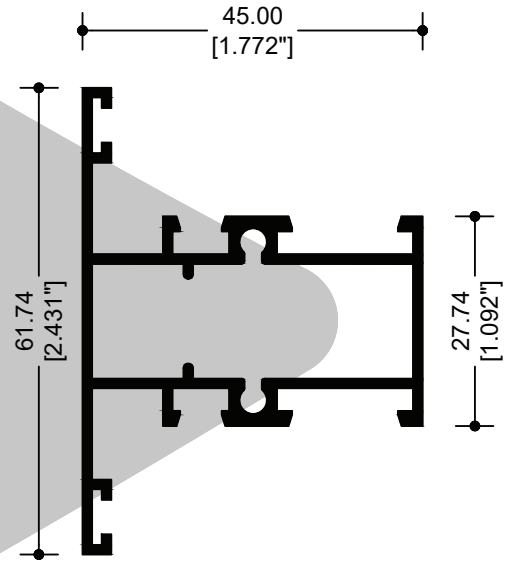

**62041**  
INTERMEDIO CUADRÍCULA

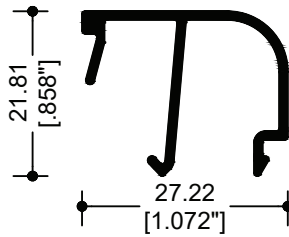

**82029**  
JUNQUILLO VIDRIO SENCILLO

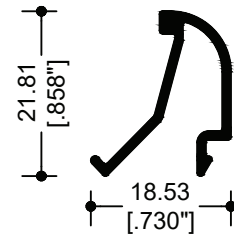

**82030**  
JUNQUILLO VIDRIO DOBLE

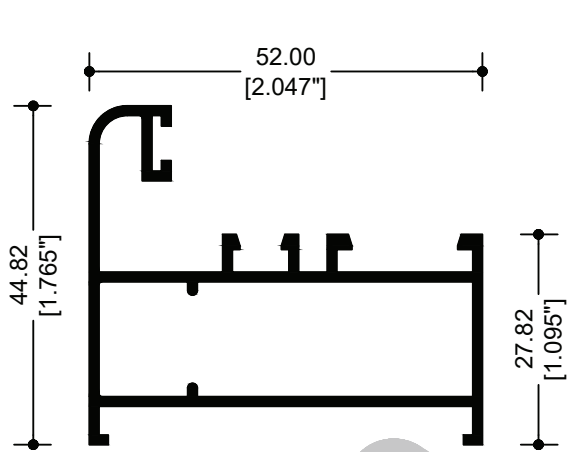

**62033**  
"L" CONTRAMARCO

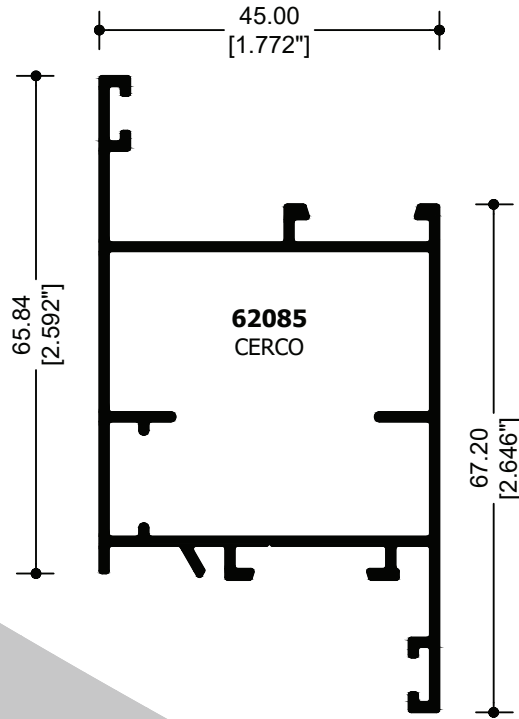

**62085**  
CERCO

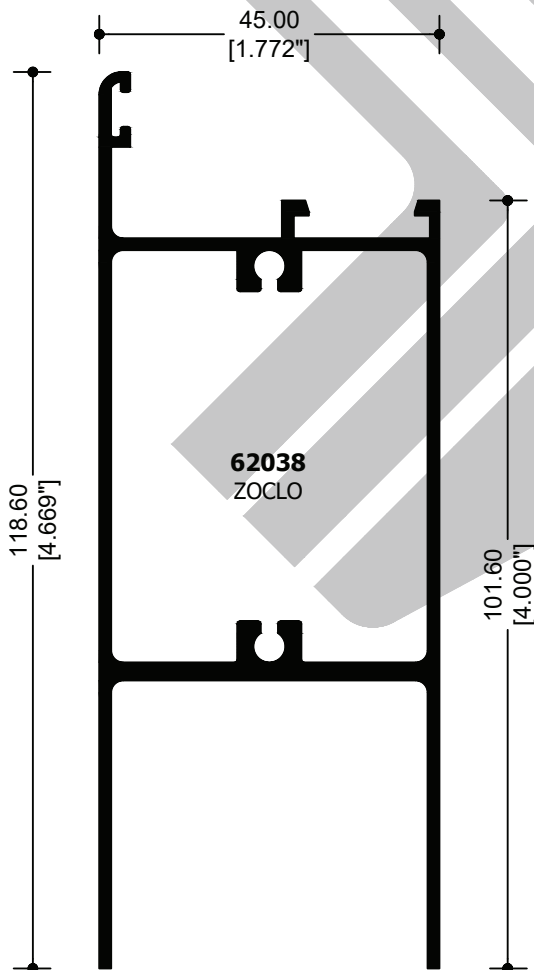

**62038**  
ZOCLO

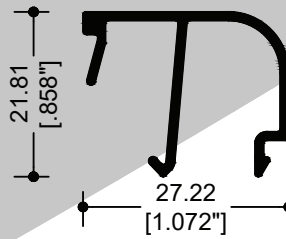

**82029**  
JUNQUILLO VIDRIO SENCILLO

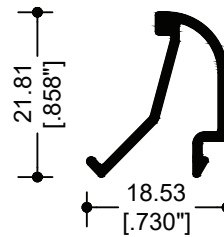

**82030**  
JUNQUILLO VIDRIO DOBLE

  
 PREMIUM  
 SERIE  
  
**S45**  

BATIENTE PUERTA

PREMIUM  
SERIE  
**S45**  
BATIENTE PUERTA

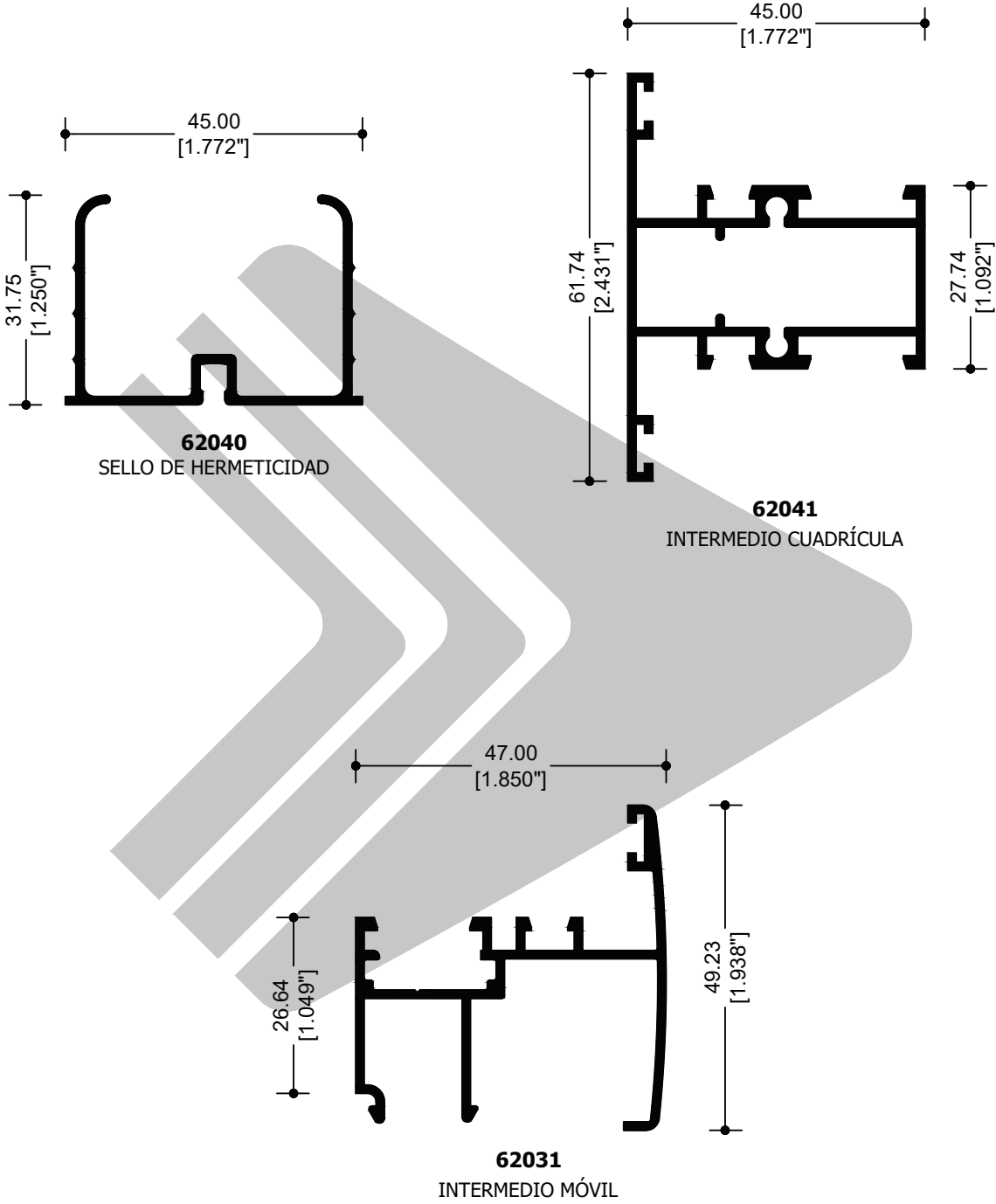

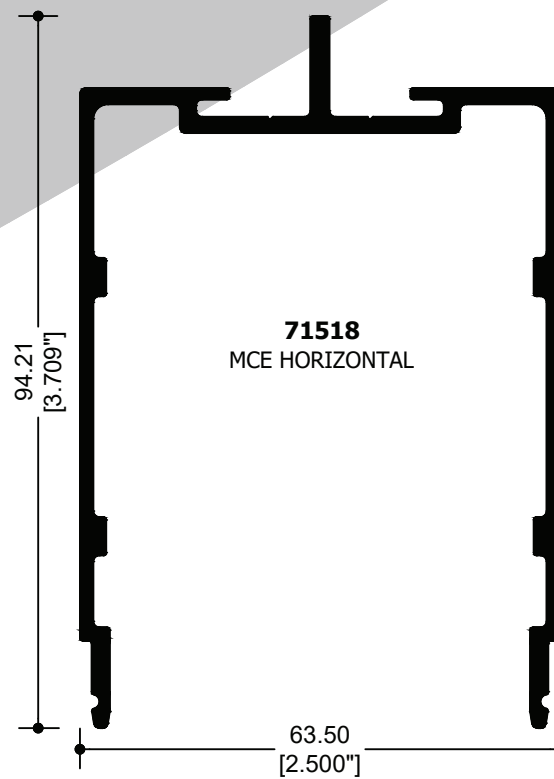
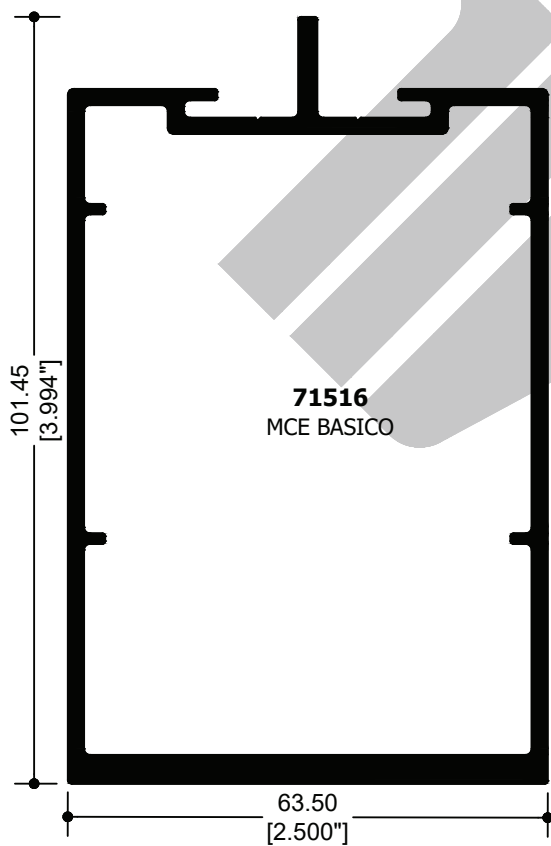
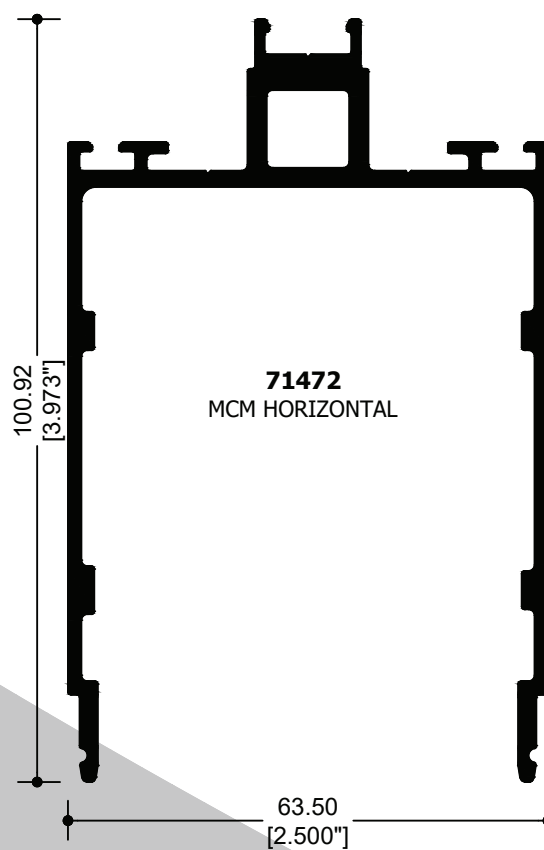
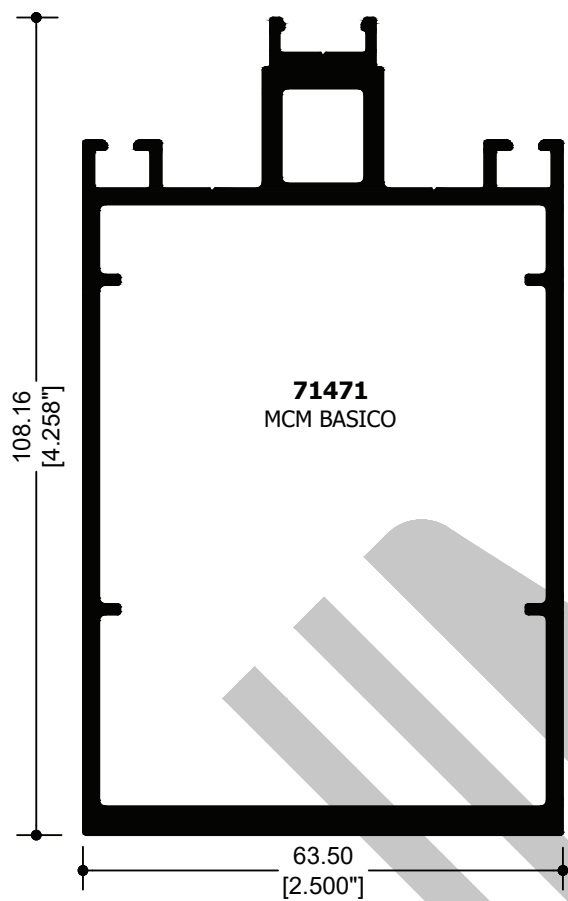

MURO CORTINA

PREMIUM  
SERIE

MC450AD

PREMIUM  
SERIE  
MC450AD  
MURO CORTINA

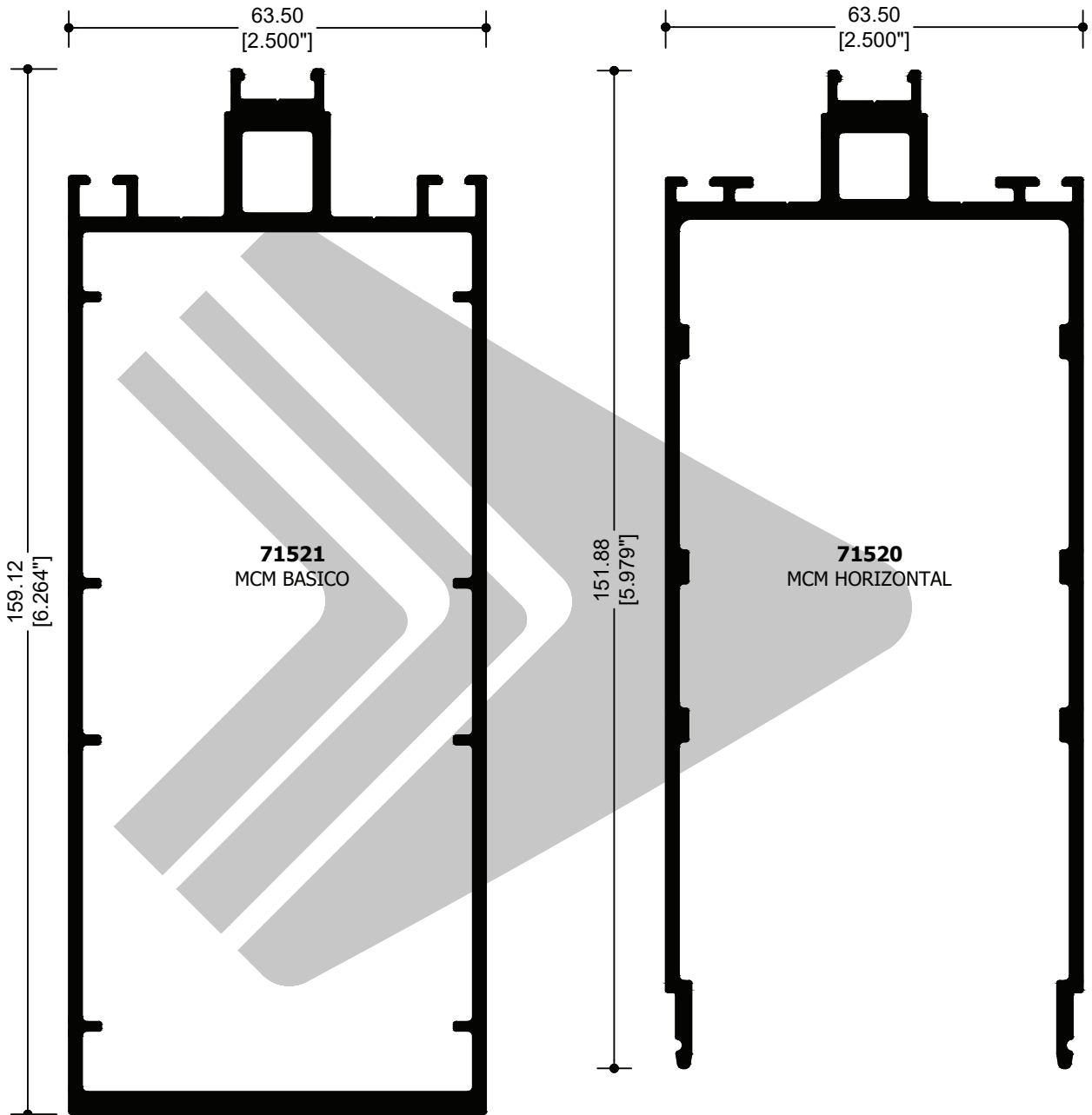

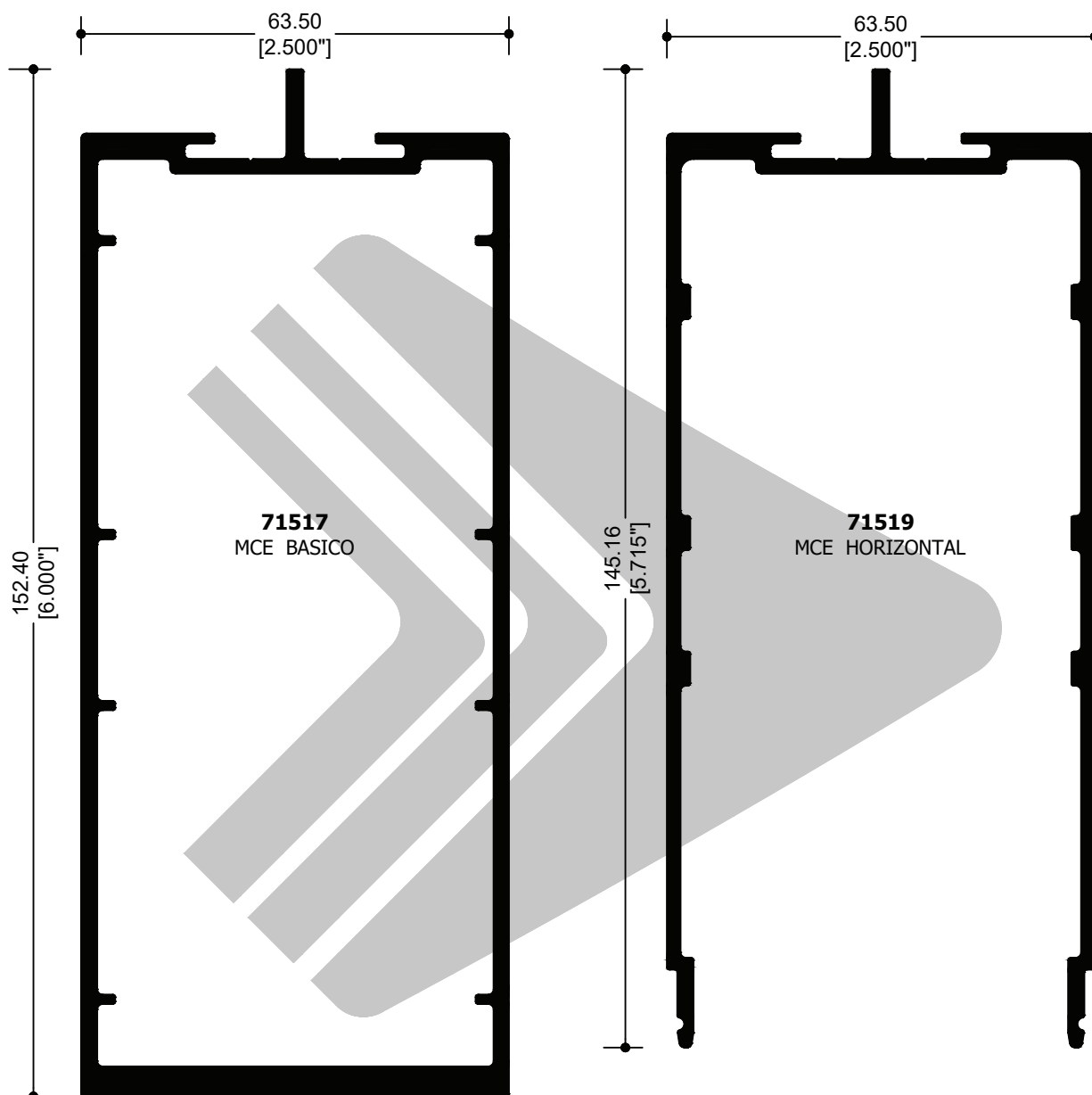

MURO CORTINA

 PREMIUM  
SERIE  
**MC450AD**

PREMIUM  
SERIE  
MC450AD  
MURO CORTINA

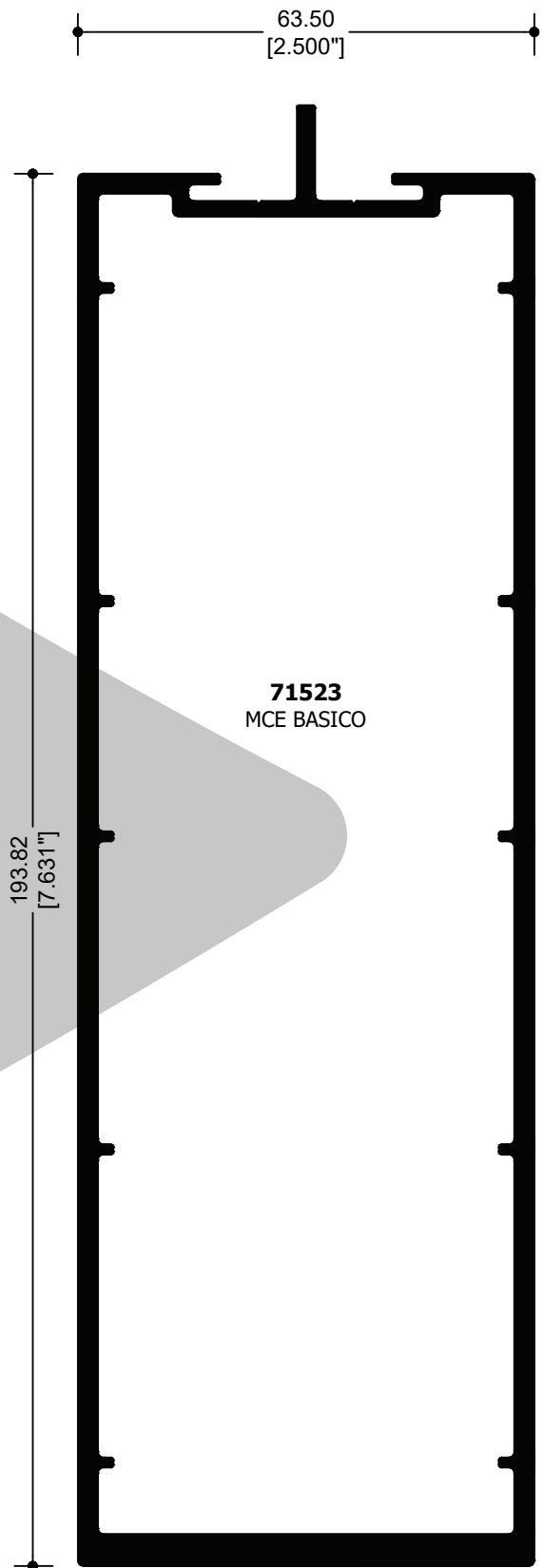
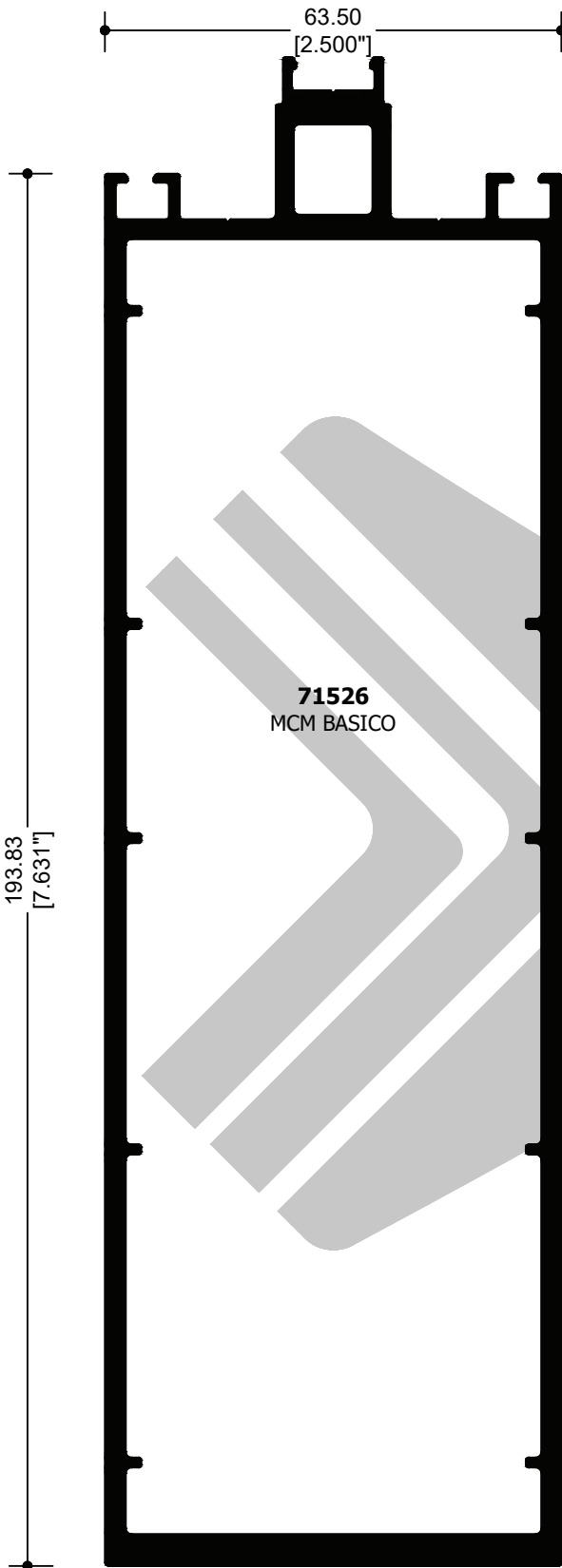



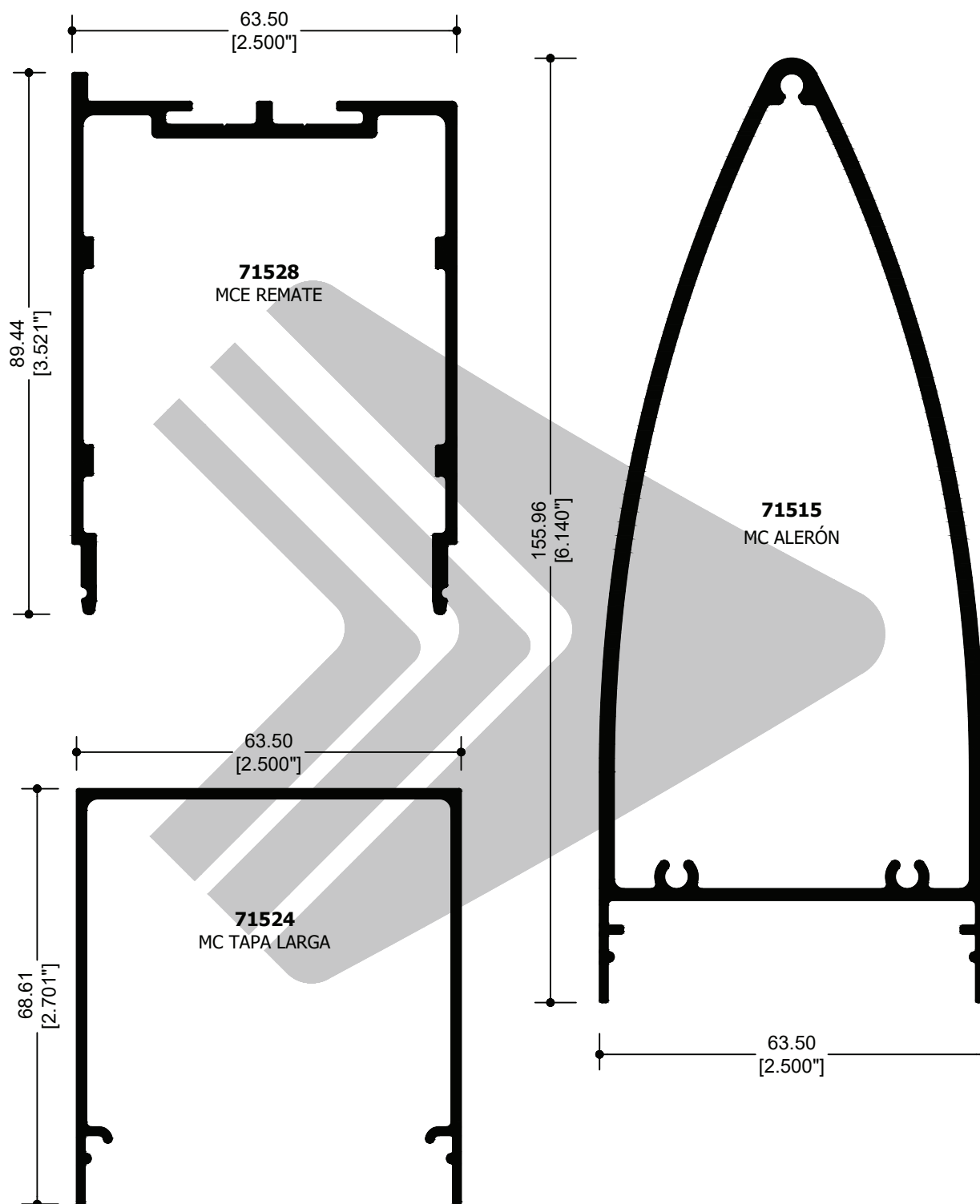

MURO CORTINA

PREMIUM

SERIE

MC450AD

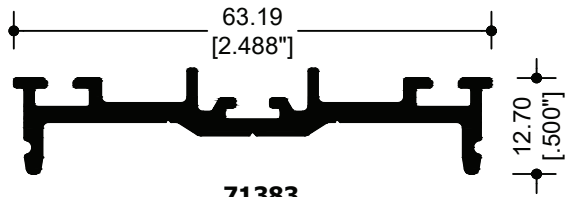

**71383**  
MCM MOLDURA UNIÓN  
6MM Y 24MM

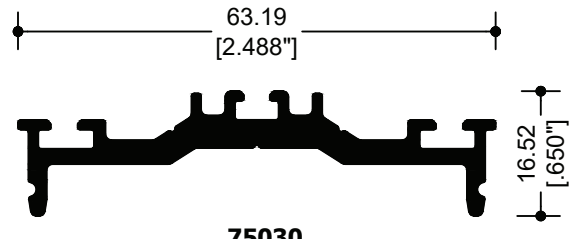

**75030**  
MCM MOLDURA UNIÓN SDN  
10MM Y 31MM

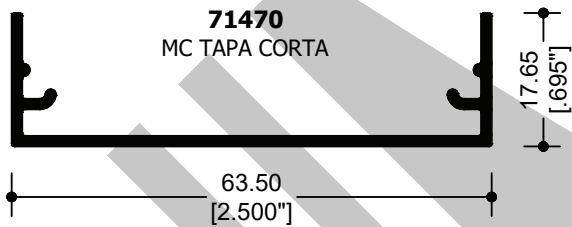

**71470**  
MC TAPA CORTA

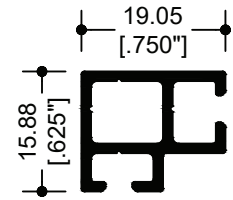

**71527**  
MCM ADAPTADOR  
9 ó 6

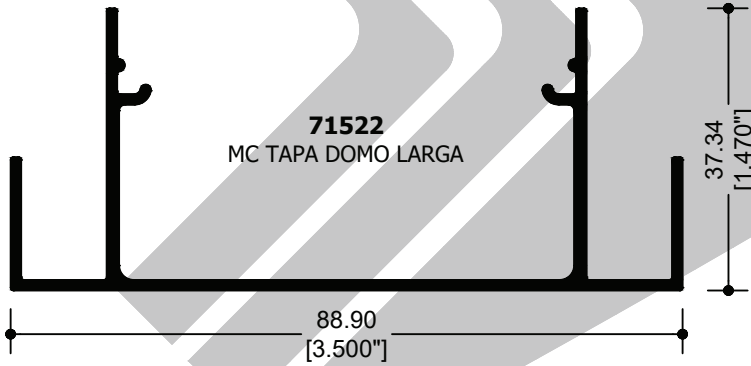

**71522**  
MC TAPA DOMO LARGA

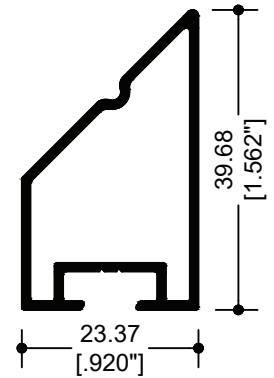

**71643**  
MC ESQUINERO  
90-270

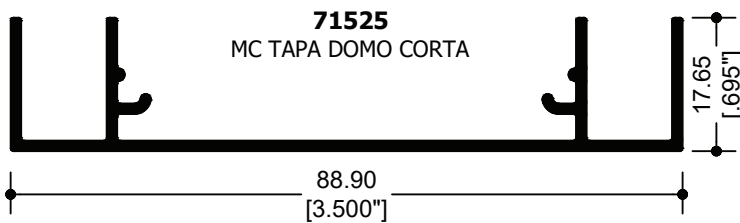

**71525**  
MC TAPA DOMO CORTA

PREMIUM  
SERIE  
MC450AD  
MURO CORTINA

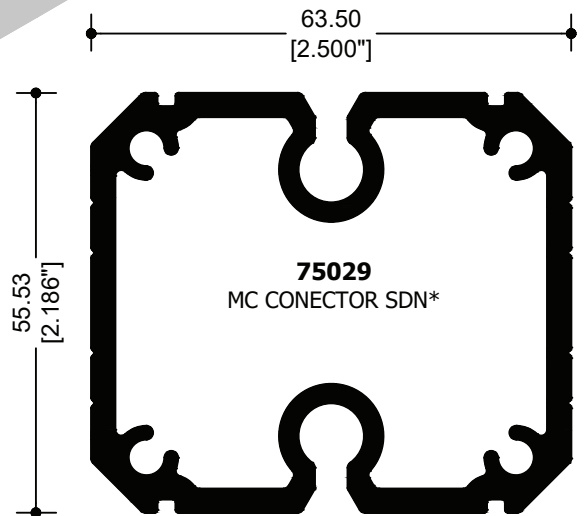
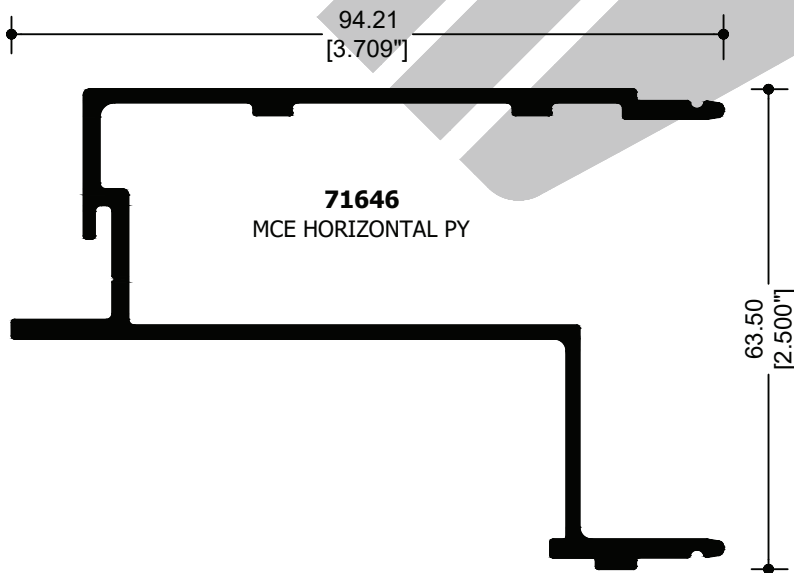
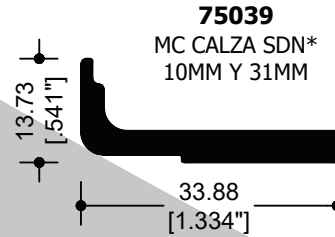
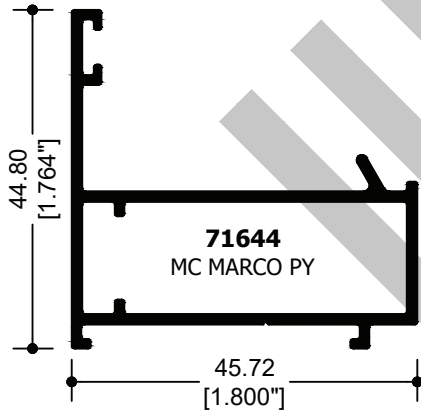
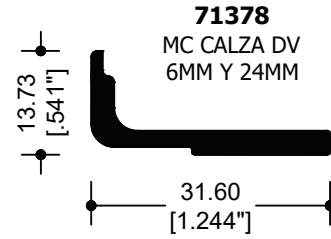
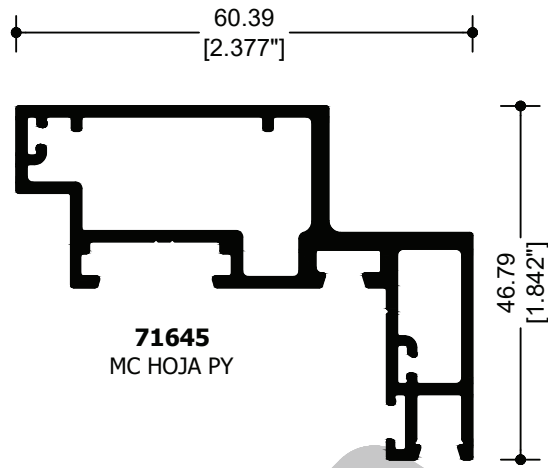

MURO CORTINA

**MC450AD**

SERIE















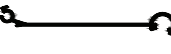

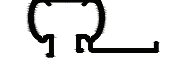





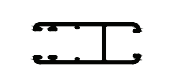

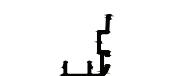

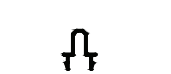

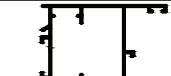
PREMIUM

\*MEDIDA ESTANDAR DE 3.66 METROS

CLAVE	FIGURA	SUP. ANOD.	SUP. EXPUESTA	LARGO STD.	PIEZAS x ATADO	PAGINA	CLAVE	FIGURA	SUP. ANOD.	SUP. EXPUESTA	LARGO STD.	PIEZAS x ATADO	PAGINA
5173		9.5	3.85	6.1	20	17 27	12506		35.43	9.50	6.1	6	7
11409		18.3	7.30	6.1	12	24	12507		15.08	3.48	6.1	20	7 12
11411		14.17	11.36	6.1	8	24	12513		36.48	9.56	6.1	4	7
12263		39.29	19.26	6.1	4	22	12542		24.41	17.38	4.6	6	28
12273		17.42	12.45	6.1	8	27	12543		13.42	2.98	6.1	20	8 29 32
12274		22.31	11.71	6.1	4	27	12544		33.94	26.91	4.6	4	30
12275		21.14	21.14	6.1	8	27	12545		23.54	10.47	6.1	4	28
12276		23.71	8.09	6.1	4	27	12547		38.54	16.74	6.1	6	21
12277		21.69	10.39	6.1	4	27	12562		40.35	21.34	6.1	4	28 31
12393		4.56	4.56	6.1	40	27	12563		13.06	5.55	6.1	20	9
12428		10.00	8.19	6.1	22	23	12566		20.79	0.0	6.1	10	29 31
12437		37.26	19.00	6.1	4	22	12569		23.98	9.08	6.1	4	28 30
12456		23.33	9.53	6.1	8	23 27	12576		12.95	2.72	6.1	20	29 32
12504		42.00	12.76	6.1	4	7	12581		21.45	4.90	6.1	8	9
12505		23.17	3.43	6.1	8	7	12592		44.08	11.50	6.1	4	8

CLAVE	FIGURA	SUP. ANOD.	SUP. EXPUESTA	LARGO STD.	PIEZAS x ATADO	PAGINA	CLAVE	FIGURA	SUP. ANOD.	SUP. EXPUESTA	LARGO STD.	PIEZAS x ATADO	PAGINA
12593		35.6	8.93	6.1	4	8	13614		61.6	25.20	6.1	3	14
12594		18.35	2.04	6.1	8	8	13615		32.27	7.14	6.1	6	14
12595		20.15	5.17	6.1	12	32	13616		21.40	6.44	6.1	12	14
12596		48.79	30.57	6.1	2	31	13617		52.72	12.20	6.1	3	14
12602		35.31	20.41	4.6	3	30	13829		60.01	17.50	6.1	2	15
12603		10.21	2.30	6.1	20	29 32	13830		55.58	12.65	6.1	4	15
12606		37.33	10.82	6.1	8	6	13831		34.44	9.53	6.1	6	15
12607		16.72	1.91	6.1	16	6	13832		19.8	5.57	6.1	16	15
12608		30.23	8.61	6.1	8	6	14384		22.60	10.16	6.1	8	16
12609		12.91	2.81	6.1	20	6	14385		50.20	22.81	6.1	4	16
12617		23.91	15.64	6.1	6	28 30	14411		14.35	11.06	6.1	5	24
12653		14.21	11.45	6.1	20	32	14412		3.22	0.0	6.1	24	42 44 54
12664		36.46	15.39	6.1	6	21	14702		21.65	11.23	6.1	20	23
12756		33.31	15.64	6.1	8	28 30	14918		20.84	7.82	6.1	12	23
13363		23.98	12.63	6.1	8	27	15043		4.39	4.39	6.1	32	30

CLAVE	FIGURA	SUP. ANOD.	SUP. EXPUESTA	LARGO STD.	PIEZAS x ATADO	PAGINA	CLAVE	FIGURA	SUP. ANOD.	SUP. EXPUESTA	LARGO STD.	PIEZAS x ATADO	PAGINA
18409		32.53	25.3	5.0	6	22	45050		4.73	0.0	6.1	24	56
18411		28.96	21.73	6.1	4	21	50701		9.27	4.75	6.1	30	17 23
18413		15.91	13.08	6.1	12	24	62014		17.49	14.13	6.1	6	44 54
18419		30.10	24.53	5.0	4	22	62026		35.53	9.58	6.1	4	55
18421		26.53	20.96	6.1	4	21	62027		36.11	8.06	6.1	4	55
22504		44.92	13.96	6.1	4	11	62031		37.70	5.87	6.1	6	56 60
22513		40.98	9.57	6.1	4	11	62032		25.80	4.62	6.1	12	56
22581		24.22	5.25	6.1	8	13	62033		30.03	8.09	6.1	4	37 55 59
22592		47.13	16.02	6.1	4	12	62035		28.13	21.63	6.1	4	57
22593		38.88	9.22	6.1	4	12	62038		44.13	22.32	6.1	3	37 57 59
22594		21.08	3.11	6.1	8	12	62039		40.57	20.86	6.1	3	58
32506		38.54	9.57	6.1	6	11	62040		24.62	24.62	6.1	4	58 60
32563		15.95	6.72	6.1	12	13	62041		32.57	9.60	6.1	4	10 56 37 60 40 58
42505		26.07	4.63	6.1	8	11	62042		16.42	3.30	6.1	12	37
42507		16.51	4.42	6.1	8	11	62046		28.92	18.61	6.1	4	57

CLAVE	FIGURA	SUP. ANOD.	SUP. EXPUESTA	LARGO STD.	PIEZAS x ATADO	PAGINA	CLAVE	FIGURA	SUP. ANOD.	SUP. EXPUESTA	LARGO STD.	PIEZAS x ATADO	PAGINA
62052		49.11	37.2	6.1	2	52	62374		55.82	36.74	6.1	4	20
62054		68.26	51.07	6.1	1	52	64206		28.28	14.4	6.1	6	54
62055		49.80	19.52	6.1	3	53	64640		31.49	23.66	6.1	6	25
62056		46.18	17.81	6.1	3	53	64641		39.90	18.75	6.1	4	25
62057		45.39	13.57	6.1	3	53	64642		39.04	31.99	6.1	4	25
62058		23.10	10.94	6.1	8	53	64643		13.50	4.86	6.1	6	25
62060		15.93	1.59	6.1	16	53	64644		41.08	13.72	6.1	4	26
62066		31.18	12.42	6.1	8	18	64645		29.52	7.24	6.1	4	26
62070		15.92	7.40	6.1	16	19	64646		50.22	30.37	6.1	2	26
62078		11.19	6.20	6.1	24	19	65191		56.10	18.29	6.1	2	33
62085		35.41	14.75	6.1	4	59	65192		42.31	18.29	6.1	2	33
62091		26.14	13.62	6.1	2	54	65194		39.32	NA	6.1	2	34
62140		44.51	10.07	6.1	4	16	65196		12.71	6.16	6.1	12	34
62145		21.33	5.06	6.1	12	38	67163		42.69	18.31	6.1	2	34
62170		28.90	6.66	6.1	8	13	67164		44.06	23.32	6.1	2	34

CLAVE	FIGURA	SUP. ANOD.	SUP. EXPUESTA	LARGO STD.	PIEZAS x ATADO	PAGINA	CLAVE	FIGURA	SUP. ANOD.	SUP. EXPUESTA	LARGO STD.	PIEZAS x ATADO	PAGINA
67428		32.60	16.52	6.1	2	33	68850		33.19	17.02	6.1	8	17
67429		58.75	27.00	6.1	2	35	69356		12.91	4.24	6.1	20	17
67430		71.53	30.86	6.1	2	35	69368		12.01	4.11	6.1	20	17
67712		18.47	15.94	6.1	2	42	69920		19.26	5.64	6.1	14	41
67739		70.83	51.21	6.1	2	32	70942		57.64	29.88	6.1	2	45
67894		32.94	15.19	6.1	4	18	70943		80.05	37.55	6.1	2	45
67899		17.29	6.55	6.1	12	19	70944		7.76	2.06	6.1	24	45 49
68299		32.95	17.23	6.1	4	19	70946		38.15	25.14	6.1	4	45
68337		30.18	14.42	6.1	4	19	70947		49.11	24.68	6.1	4	46 48
68842		45.34	17.27	6.1	6	17	70948		39.36	24.95	6.1	4	46
68843		30.61	12.70	6.1	10	17	70949		47.13	26.04	6.1	2	47
68844		26.81	18.57	6.1	8	17	70950		34.03	27.56	6.1	4	47
68845		35.59	16.10	6.1	8	17	70951		28.06	12.17	6.1	6	49
68846		21.10	10.54	6.1	8	17	70952		23.63	9.87	6.1	4	45
68847		15.17	9.32	6.1	20	17	70953		28.15	13.37	6.1	6	46



CLAVE	FIGURA	SUP. ANOD.	SUP. EXPUESTA	LARGO STD.	PIEZAS x ATADO	PAGINA	CLAVE	FIGURA	SUP. ANOD.	SUP. EXPUESTA	LARGO STD.	PIEZAS x ATADO	PAGINA
70954		20.70	8.53	6.1	6	49	71254		41.20	32.30	6.1	2	51
70956		29.42	5.71	6.1	6	46	71255		23.12	7.54	6.1	12	41
70957		48.40	35.35	6.1	2	47	71256		20.86	6.43	6.1	12	41
70997		51.84	31.77	6.1	2	48	71354		45.09	24.76	6.1	4	41
70998		73.09	41.15	6.1	2	48	71378		8.62	0.00	6.1	15	67
70999		34.69	23.45	6.1	4	45 50	71383		21.83	0.00	6.1	6	66
71205		45.37	22.95	6.1	2	46	71470		21.41	9.89	6.10	10	66
71206		35.91	23.23	6.1	4	46	71471		75.42	25.42	6.1	2	61
71207		26.45	15.89	6.1	4	49	71472		60.29	15.27	6.1	2	61
71208		21.47	3.42	6.1	12	46	71515		42.26	32.62	6.1	1	65
71209		30.85	16.09	6.1	6	49	71516		35.93	28.63	6.1	2	61
71210		44.95	34.07	6.1	2	47	71517		46.12	39.07	6.1	1	63
71251		43.43	?	6.1	2	41	71518		53.10	18.60	6.1	2	61
71252		40.77	29.41	6.1	4	50	71519		72.89	28.79	6.1	2	63
71253		46.04	30.14	6.1	2	41	71520		76.57	24.90	6.1	2	62

CLAVE	FIGURA	SUP. ANOD.	SUP. EXPUESTA	LARGO STD.	PIEZAS x ATADO	PAGINA	CLAVE	FIGURA	SUP. ANOD.	SUP. EXPUESTA	LARGO STD.	PIEZAS x ATADO	PAGINA
71521		51.60	34.94	6.1	2	62	72607		79.68	35.20	6.1	2	50
71522		40.47	19.83	6.1	4	66	72608		43.68	20.87	6.1	4	50
71523		56.28	49.28	6.1	1	64	72609		8.61	3.32	6.1	20	45 49
71524		41.48	20.05	6.1	4	65	72610		46.02	20.62	6.1	4	51
71525		32.87	12.68	6.1	6	66	73643		21.59	6.80	6.1	10	41
71526		61.79	45.13	6.1	1	64	74272		11.17	9.59	6.1	18	29 32
71527		10.86	4.09	6.1	16	66	74268		15.29	8.42	6.1	16	29
71528		52.13	19.48	6.1	2	65	75029		29.15	0.00	3.66	2	67
71643		13.31	9.09	6.1	10	66	75030		22.50	0.00	6.10	6	66
71644		21.53	15.38	6.1	6	67	75039		9.09	0.00	3.66	15	67
71645		27.62	20.89	6.1	4	67	78407		40.04	19.52	6.1	4	20
71646		50.28	20.57	6.1	2	67	78408		34.95	5.64	6.1	8	20
72373		50.53	26.83	6.1	2	20	78410		34.29	21.38	6.1	4	22
72535		27.62	15.50	6.1	2	51	78412		30.71	17.81	6.1	4	21
72536		34.67	9.79	6.1	2	46 50	78420		31.86	21.38	6.1	4	22

CLAVE	FIGURA	SUP. ANOD.	SUP. EXPUESTA	LARGO STD.	PIEZAS x ATADO	PAGINA	CLAVE	FIGURA	SUP. ANOD.	SUP. EXPUESTA	LARGO STD.	PIEZAS x ATADO	PAGINA
78422		28.29	17.81	6.1	4	21	82093		31.62	10.98	6.1	4	10
82000		38.61	23.74	6.1	4	43	82047		41.05	20.12	6.1	2	40
82001		36.26	15.59	6.1	6	43	82079		26.29	8.19	6.1	6	10
82002		19.7	8.8	6.1	14	44	82103		17.64	9.39	6.1	12	44
82004		34.63	15.06	6.1	6	43	81642		4.30	2.20	6.1	108	27
82017		54.41	27.28	6.1	2	43	84207		20.85	11.68	6.1	8	44
82019		32.59	15.96	6.1	6	43	87734		36.36	14.32	6.1	2	39
82029		15.81	4.46	6.1	16	39	87896		31.74	19.83	6.1	4	18
82030		11.15	2.55	6.1	24	39	88300		43.87	26.84	6.1	4	18
82092		33.99	10.11	6.1	4	39							



Este manual y sus diseños están protegidos por diversas patentes.  
Los perfiles y sus diseños son propiedad exclusiva de Cuprum.  
Queda estrictamente prohibida su reproducción, total o parcial.



CUPRUM





#### **Planta y Ventas en México**

Av. La Presa # 290, Col. San Juan Ixhuatepec  
Tlanepantla, Edo. de México, C.P. 54180  
Tels.: (55) 5 746 7900 / (55) 5746 7800 / (55) 5746 7975

#### **Planta y Ventas en Guadalajara**

Antigua Carretera a Chapala # 3345, Alamo Industrial  
Guadalajara, Jalisco, C.P. 44470  
Tel.: (33) 3666 9000

#### **Sala de Exhibición Monterrey**

Plaza Tanarah/ Av Vasconcelos 345 Ote., Segundo piso  
Local 17 y 18, San Pedro Garza García, Nuevo León.  
Tel: (81) 8356 6529, 8356 6611, 8356 6263

#### **Planta y Ventas en Monterrey**

Av. Diego Días de Berlanga # 132 Nte., Col. El Nogalar,  
San Nicolás de los Garza, N.L., C.P. 66480  
Tels.: (81) 8305 8500 / (81) 8305 8600

#### **Sala de Exhibición Ciudad de México**

Altavista #79 entre Av. Revolución y Camino a Desierto de  
los Leones, Col. San Angel Inn, Del. Álvaro Obregón, CDMX  
Tel: (55) 5550 3690, (55) 5616 6674, (55) 5616 7308

<https://cuprum.com/construccion/>

