

PANORAMA^{MR}



CPSP-2024 240624
241016

SÓLO PERFILES
2024-2025



CUPRUM



PANORAMA

PANORAMA

Somos **CUPRUM**, una empresa 100% mexicana, líder en la industria del aluminio, con más de 70 años de experiencia en el mercado. A lo largo de nuestra trayectoria, hemos consolidado un proceso de producción completamente vertical, que abarca desde la fundición, extrusión, hasta los acabados finales, todos ejecutados bajo los más altos estándares de calidad y precisión.

La innovación en el diseño, junto con nuestra excelencia en atención y servicio, nos ha posicionado como la opción preferida en el mercado de la construcción. Nos enorgullece presentar la nueva edición de nuestro **Catálogo Panorama 2024-2025**, una línea exclusiva diseñada para satisfacer las necesidades de los proyectos de vivienda de interés social y media. En esta edición, encontrará una amplia gama de soluciones que incluyen perfiles para sistemas de ventanas fijas, corredizas y batientes, así como cancelles de baño, pasamanos y fachadas arquitectónicas, entre otros productos.

En Cuprum, nuestro compromiso es continuar desarrollando y formando a los profesionales del aluminio, siempre con el objetivo de superar las expectativas de nuestros clientes y brindar soluciones de excelencia.

Alumineros hay muchos, pero profesionales del aluminio... ¡solo Cuprum!



**Pintura electrostática**

- 100 - Blanco
- 101 - Hueso
- 108 - Champagne
- 107 - Negro
- 184 - Chocolate
- 737 - Gris Europa

Anodizados

- 005 - Champagne Brillante
- 010 - Natural Brillante
- 011 - Natural Mate
- 040 - Champagne Mate
- 084 - Bronce oscuro

Acabados Madera

- 601 - Madera Cerezo
- 603 - Nogal Texturizado

Fijos

Fijo de 1.500" x 1.084"	4
Fijo Serie 1400	5
Fijo de 2.000" x 1.250"	6
Fijo de 3.000" x 1.750"	7
Fijo de 3.000" x 1.250"	9
Fijo de 3.000" x 1.250" Doble Vidrio	10
Fijo de 4.000" x 1.750"	11

Corredizas

Ventana Económica de 1.500" C-Light	13
Ventana y Puerta Corrediza 2.000" x 1.250"	14
Ventana y Puerta Corrediza 3.000" x 1.250"	16
Mosquiteros y Adaptadores	19
Ventana Guillotina California 1.670"	20
Puerta Corrediza California 3.625"	21

Ventanas

Ventana Batiente Serie 1400	22
Ventana de Proyección 2.000"	23
Ventana Sifón 3.000"	24

Puertas

Puerta Batiente de 1.000" Económica	25
Puerta Batiente Serie 1400	26
Puerta Batiente de 1.750" Comercial	28

Cancel de Baño

Cancel de Baño de Lujo y Semi Lujo	30
Cancel de Baño Ligero	31
Cancel de Baño Varios	32

Aparadores y Vitrinas

32

Recubrimientos

33

Sardinell y Repizón

34

Zoclos

35

Pasamanos

36

Celosías Louver

37

Fachada Arquitectónica

39

Std. Arquitectónico

42

Índice General

44



CUPRUM



CUPRUM

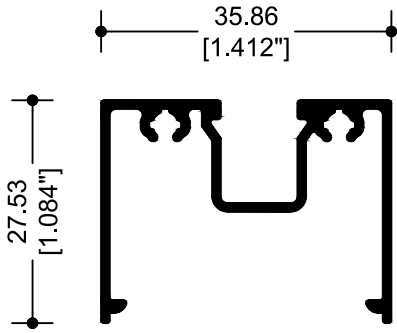

39073
BOLSA

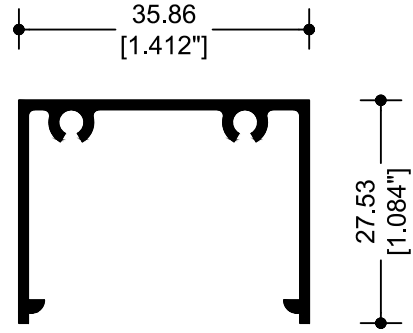

29076
BOLSA LISA

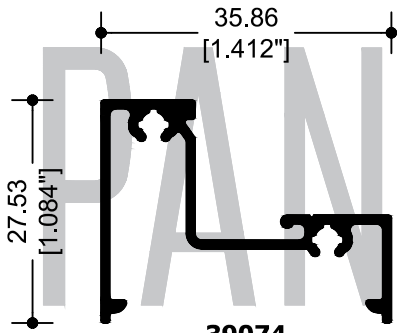

39074
ESCALONADO

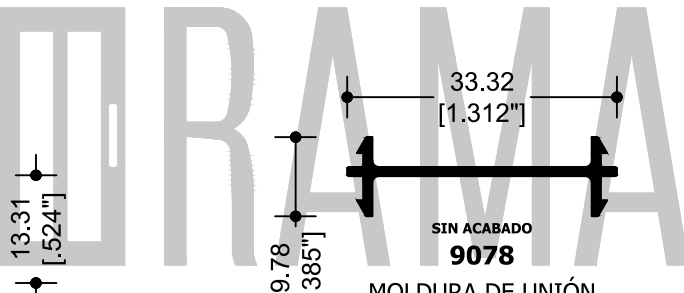

9078
MOLDURA DE UNIÓN
MULLION
PRODUCCIÓN

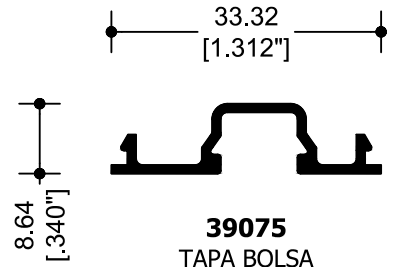

39075
TAPA BOLSA

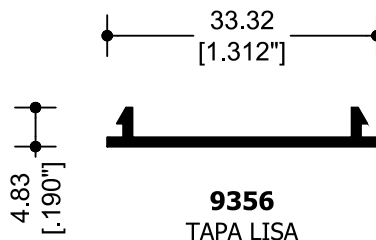

9356
TAPA LISA

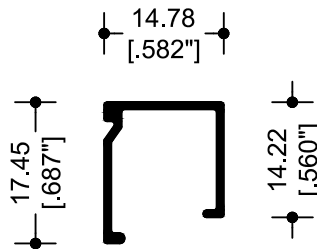

36370
JUNQUILLO

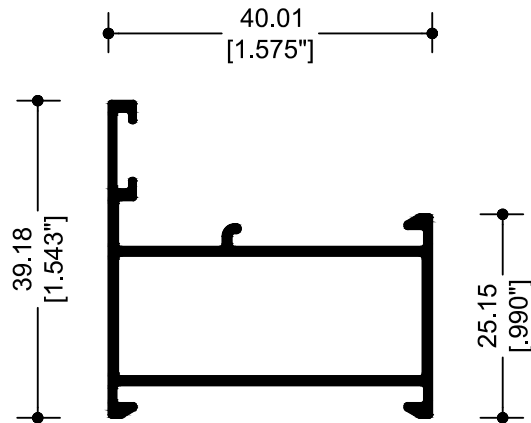

73971
CERCO LISO VENTANA

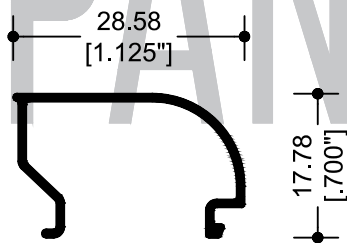

74073
JUNQUILLO REDONDO ANCHO

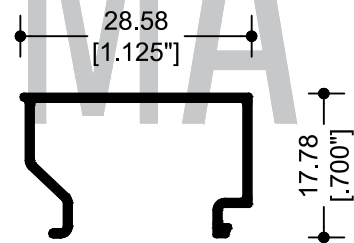

73978
JUNQUILLO ANCHO

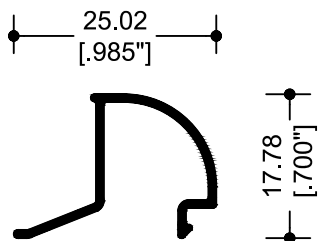

74634
JUNQUILLO REDONDO ESTRECHO

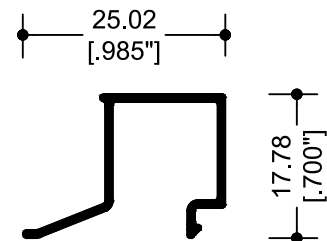

74635
JUNQUILLO ESTRECHO

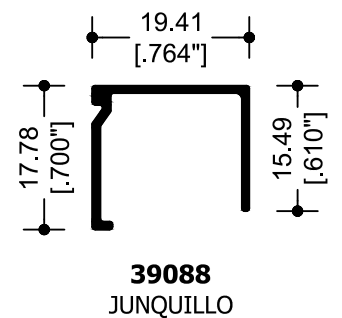
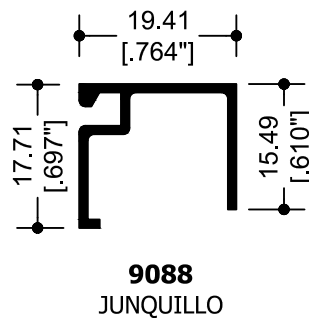
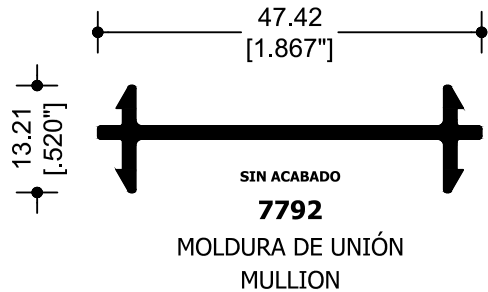
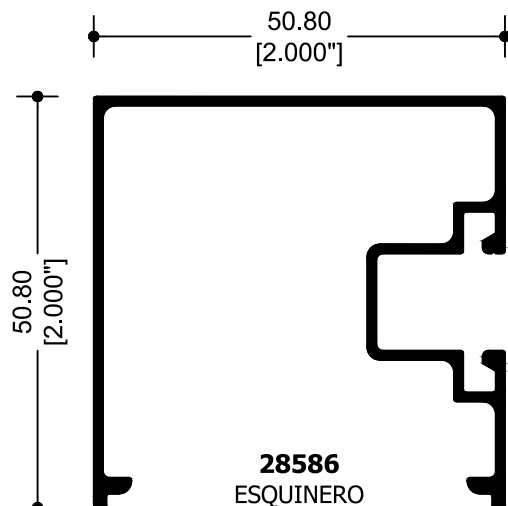
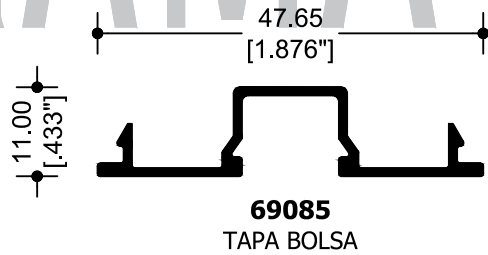
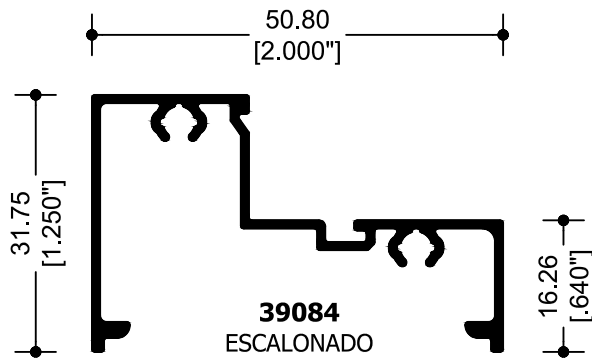
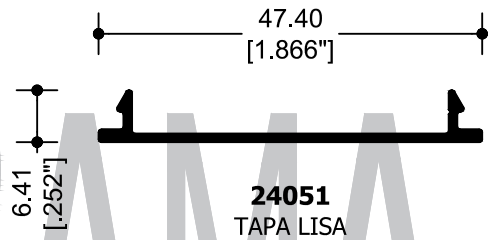
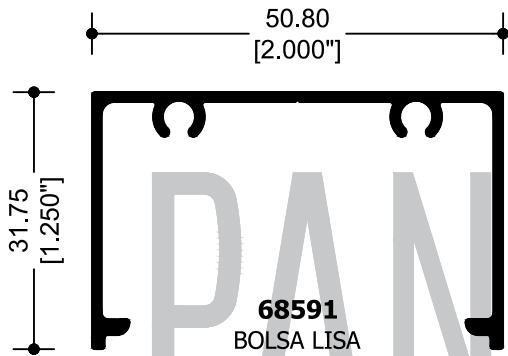
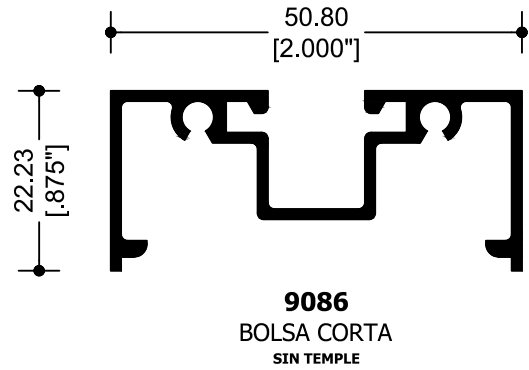
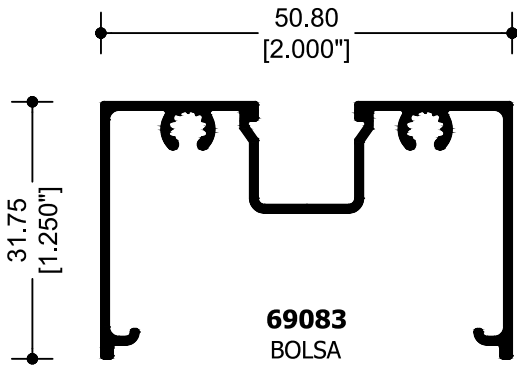

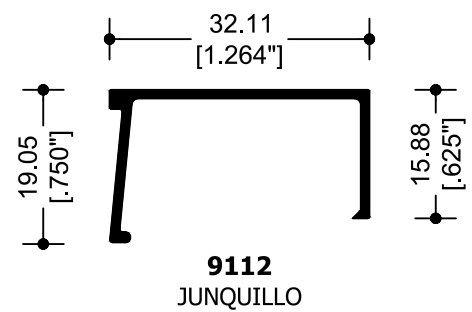
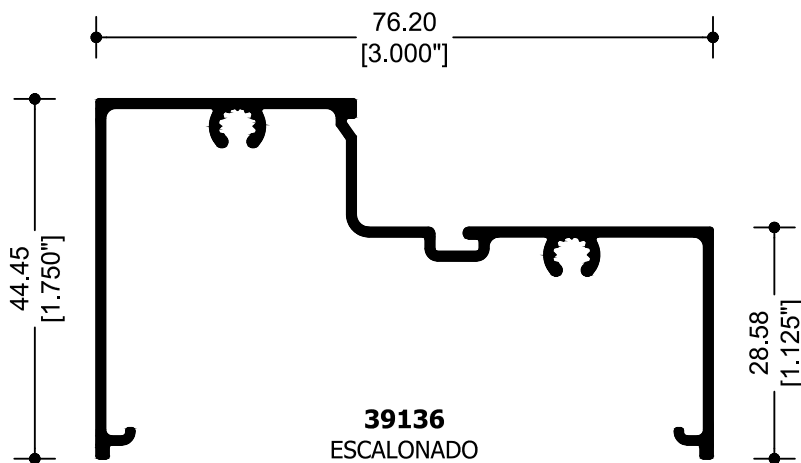
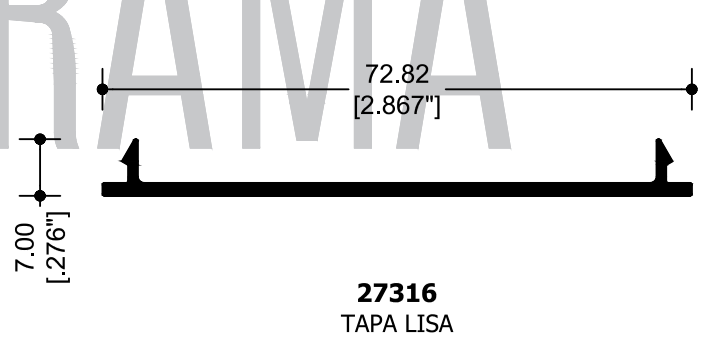
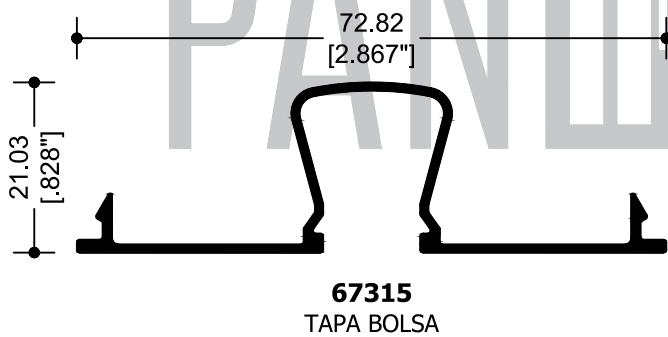
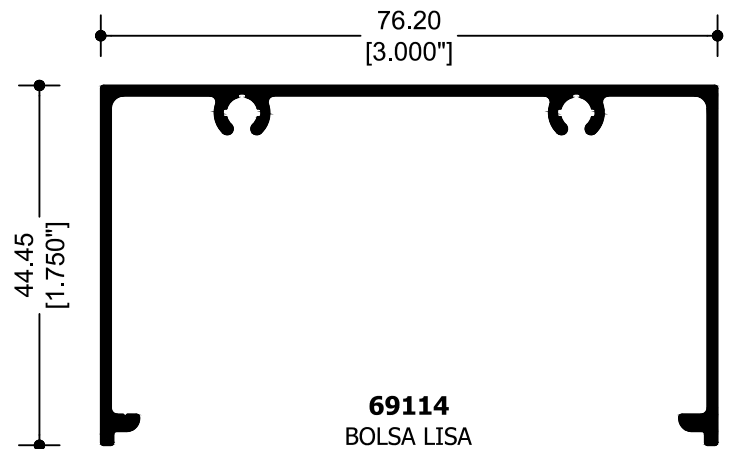
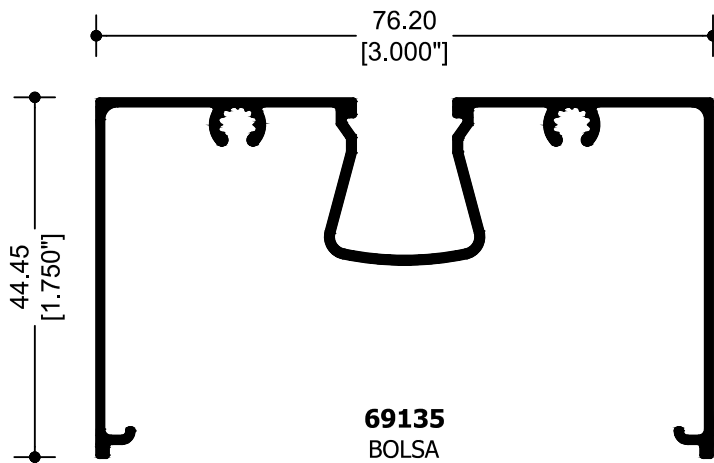

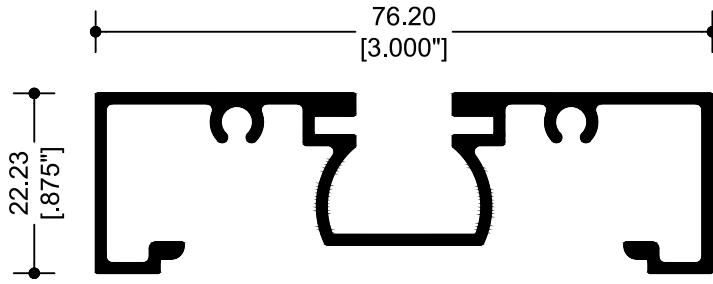

69105
BOLSA CORTA
SIN TEMPLE Y TEMPLE 05

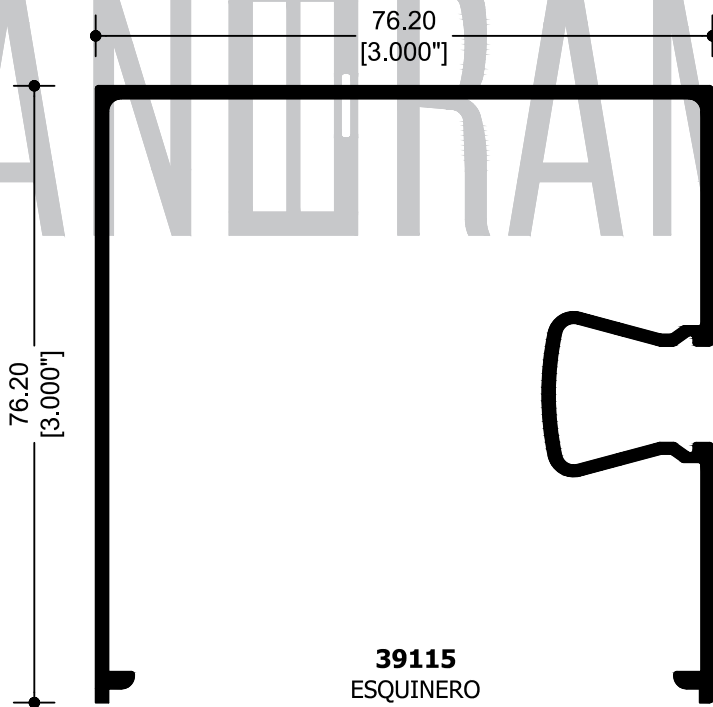
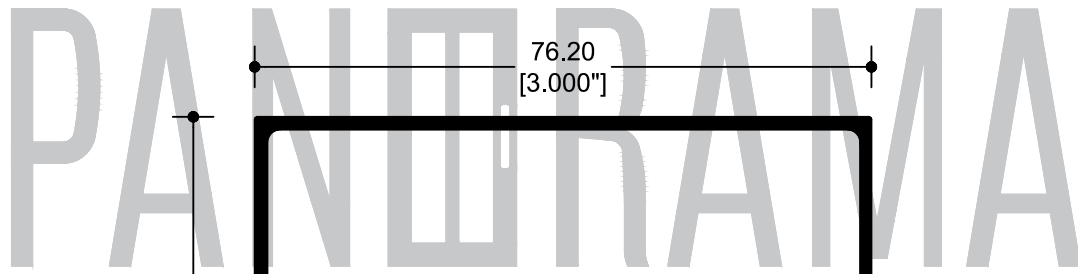

39115
ESQUINERO

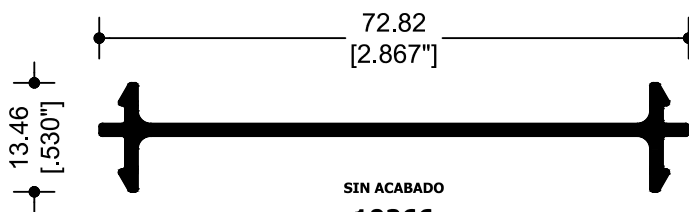

SIN ACABADO
10266
MOLDURA DE UNIÓN
MULLION

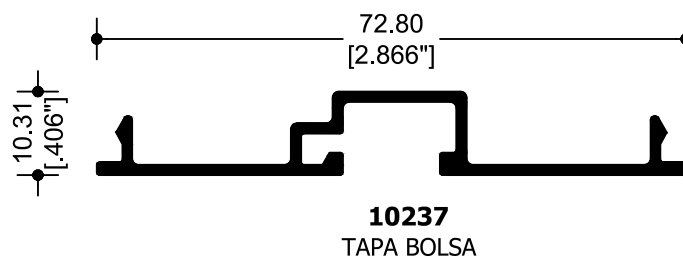
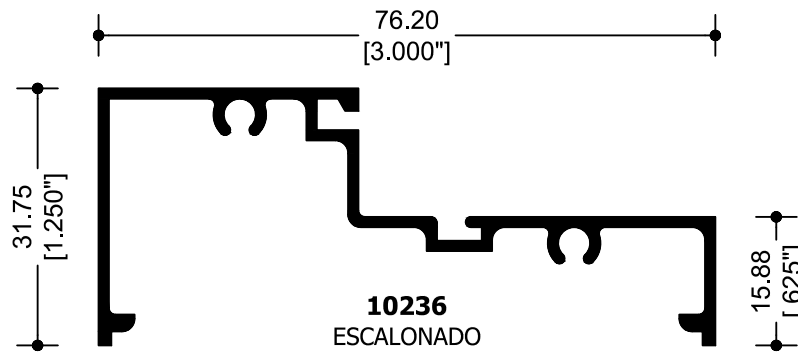
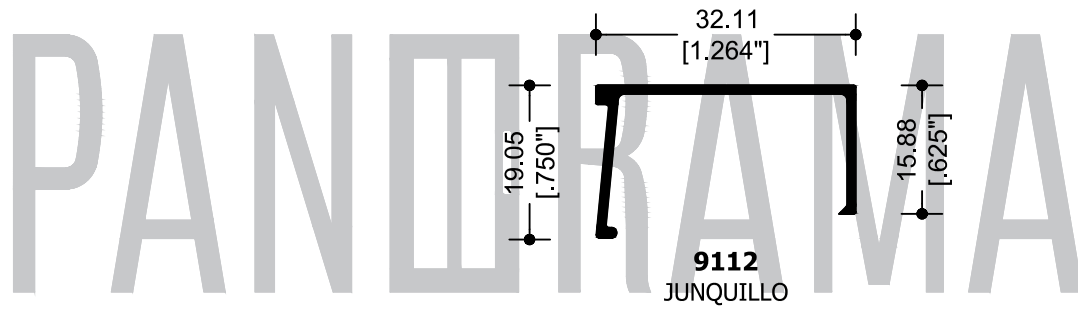
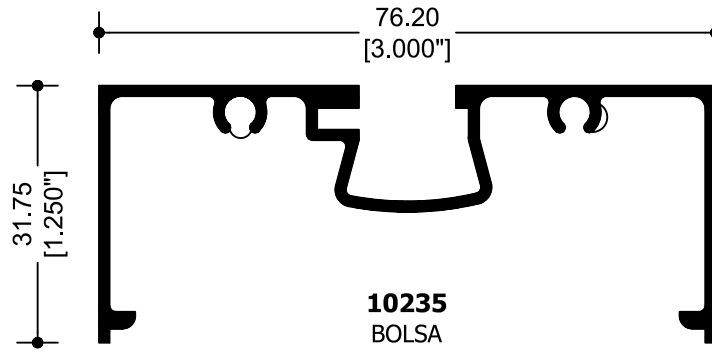

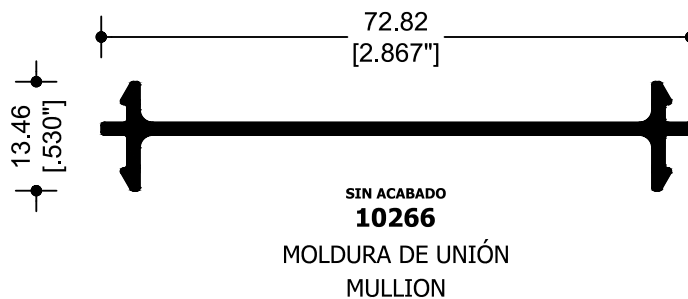
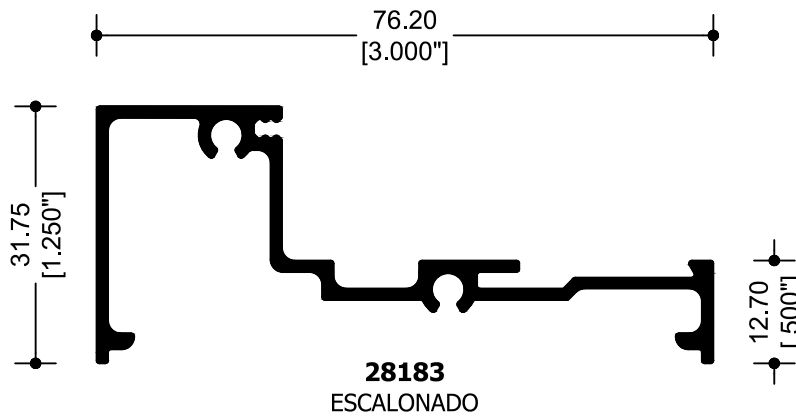
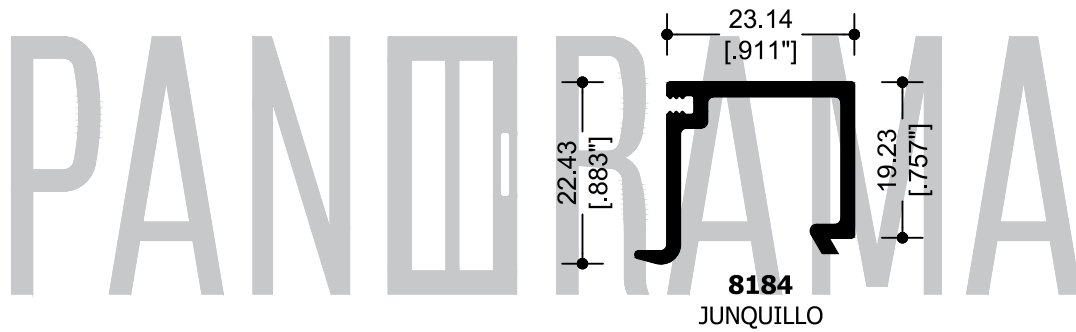
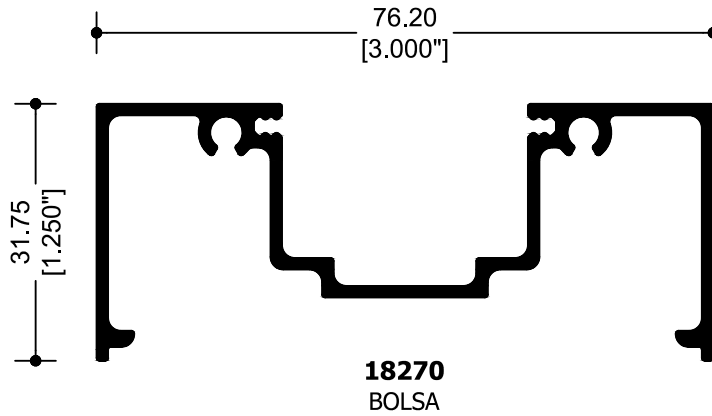

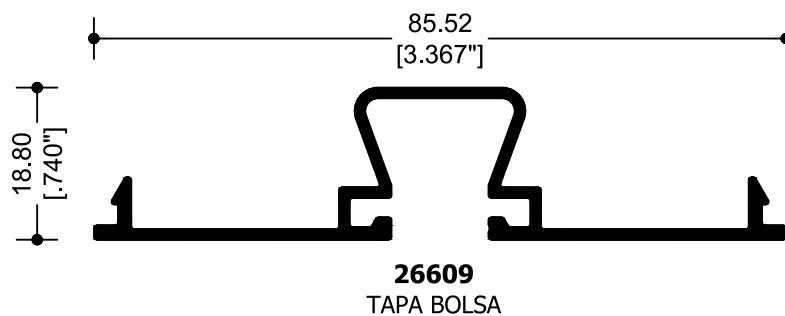
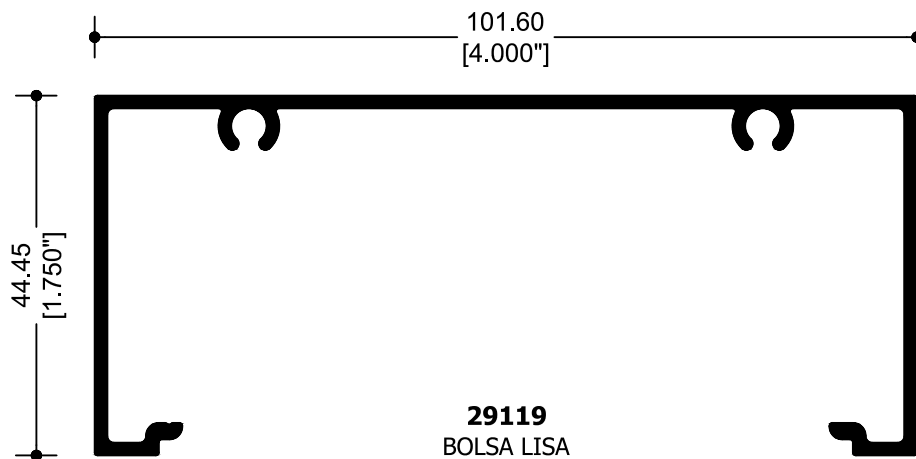
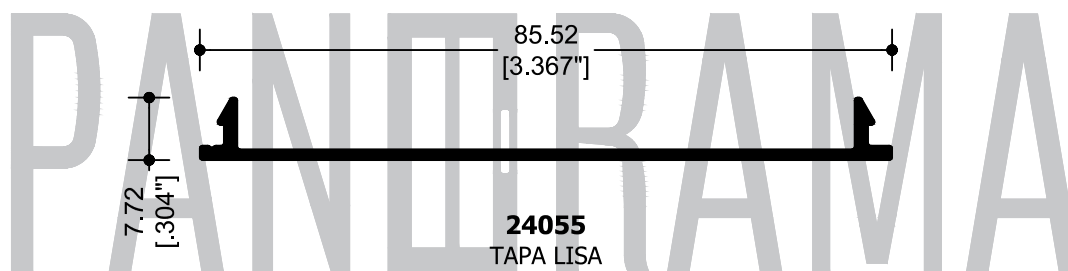
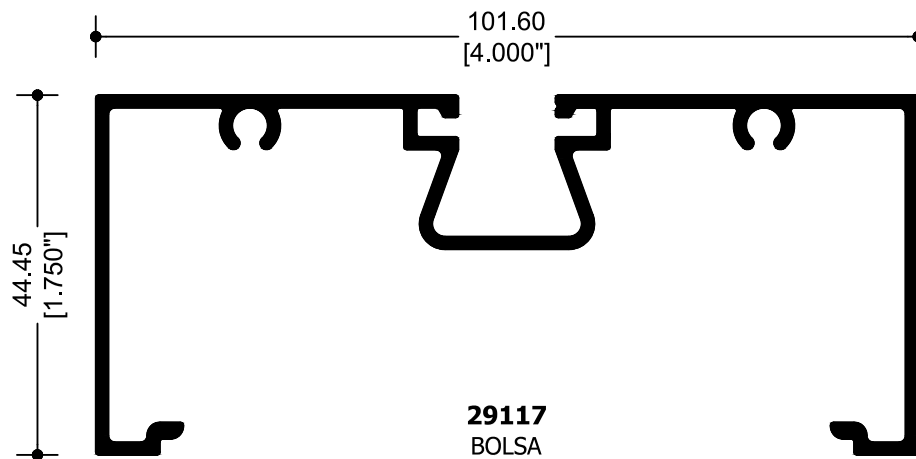

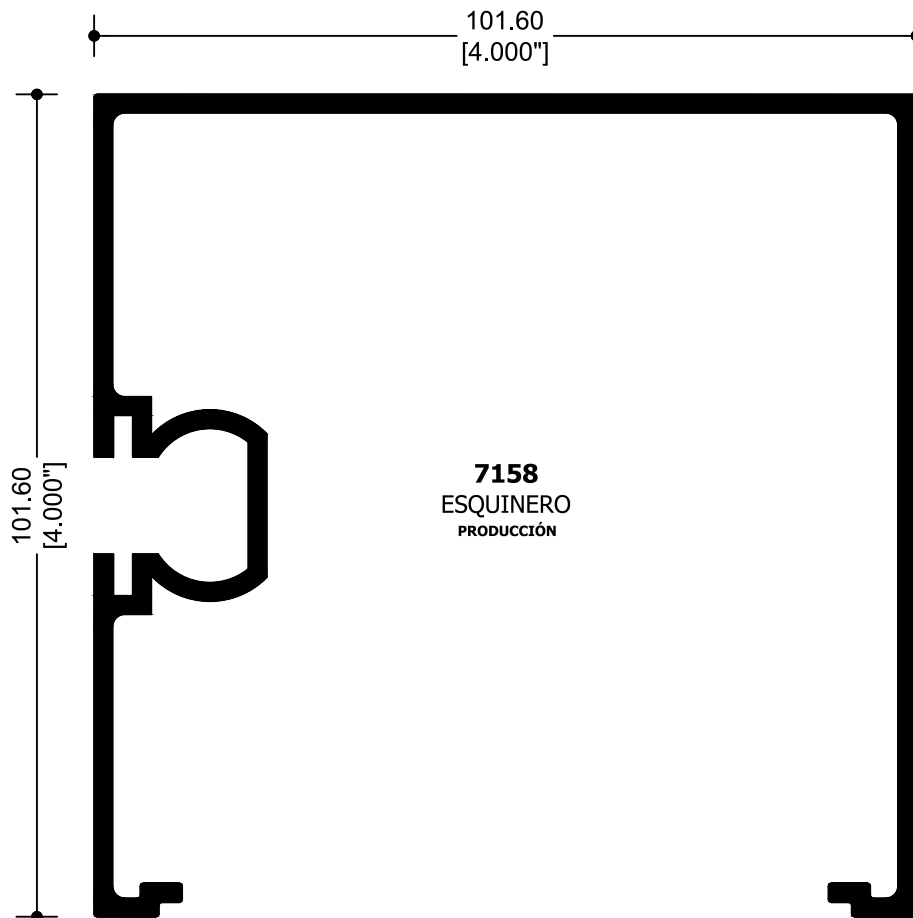
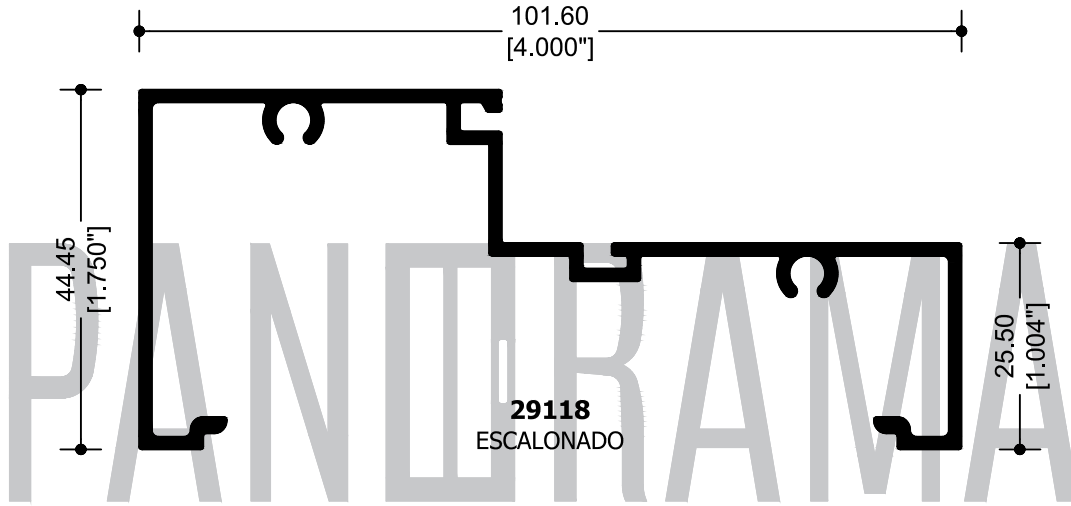
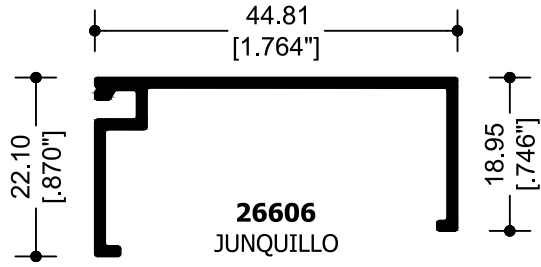

C-LIGHT IV

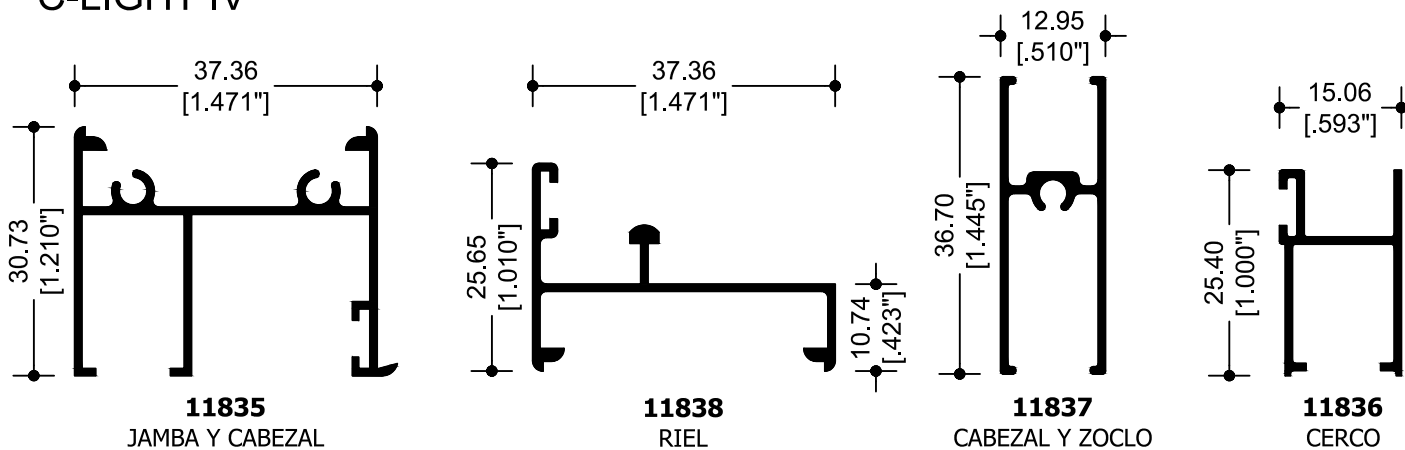

C-LIGHT V

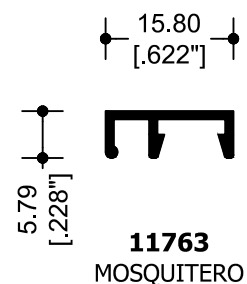
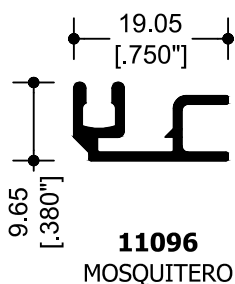
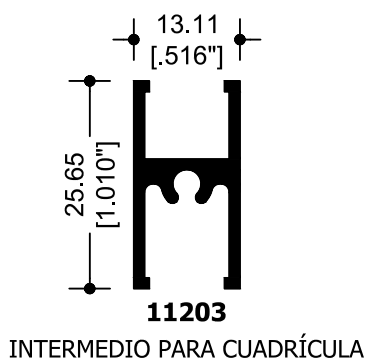
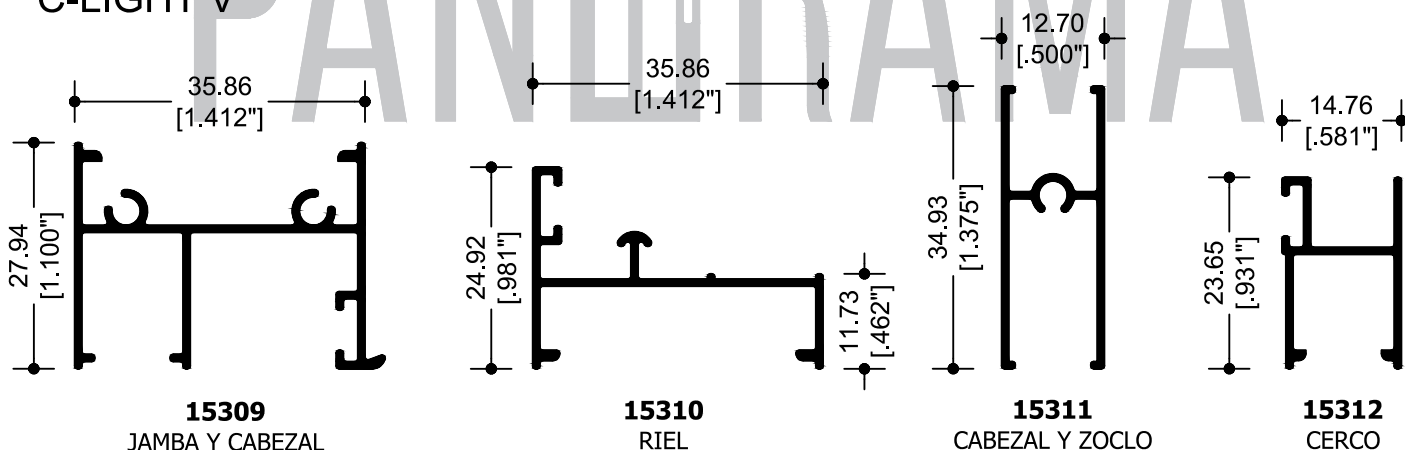

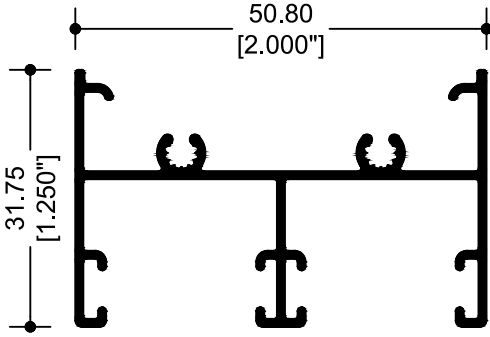

67518
CABEZAL Y JAMBA

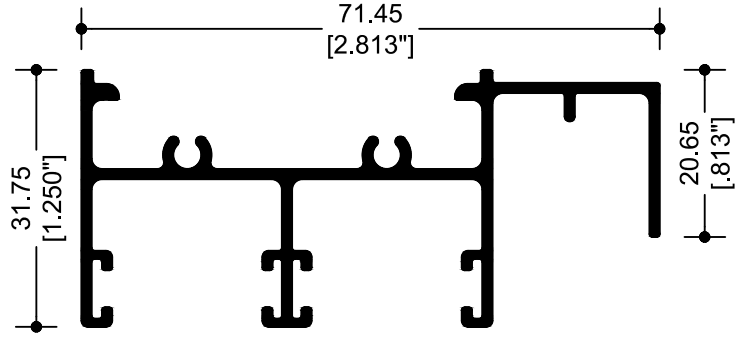

27819
CABEZAL MOS. CORREDIZO

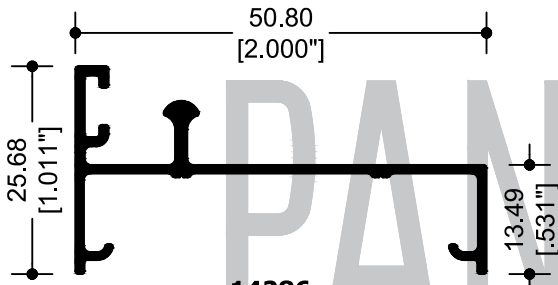

14286
RIEL

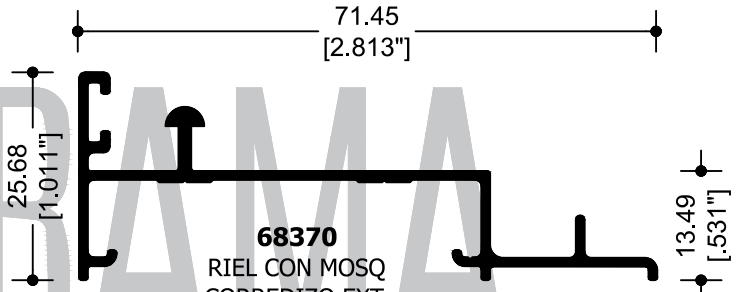

68370
RIEL CON MOSQ
CORREDIZO EXT.

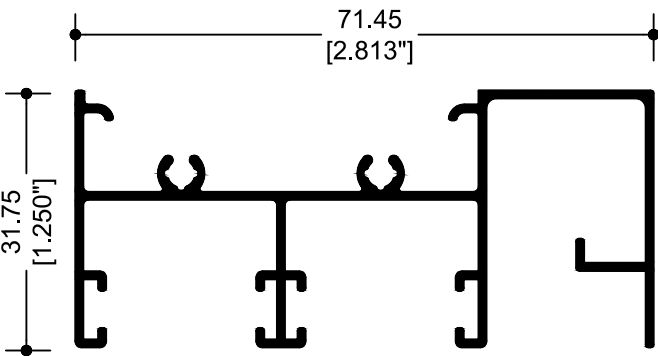

67819
CABEZAL MOSQUITERO COLGANTE

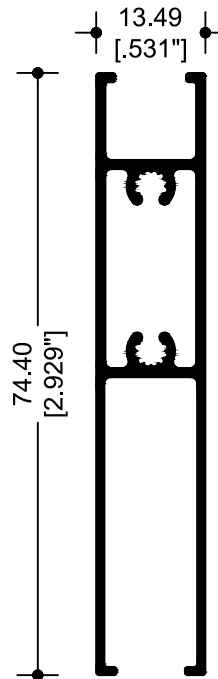

37825
ZOCLO PUERTA

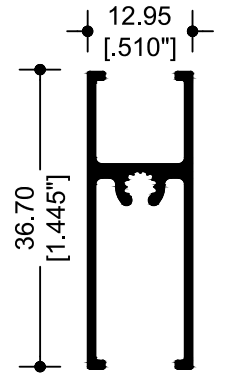

11044
CABEZAL Y ZOCLO

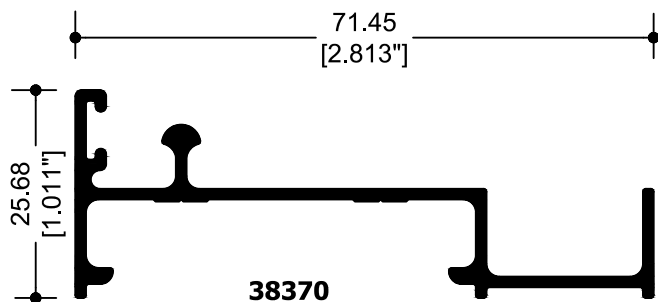

38370
RIEL CON MOSQ. EXT

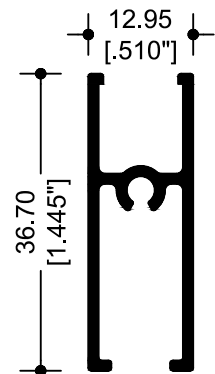

9956
CABEZAL Y ZOCLO

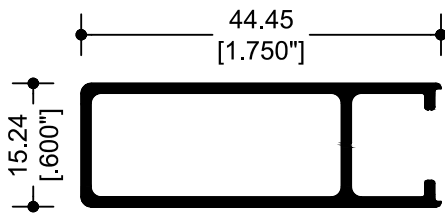

67821
CERCO PUERTA

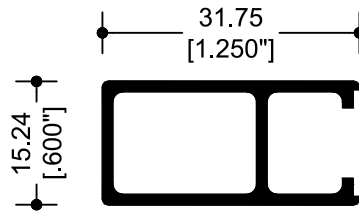

8320
CERCO VENTANA

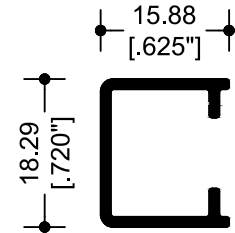

27525
CERCO FIJO ECONÓMICO

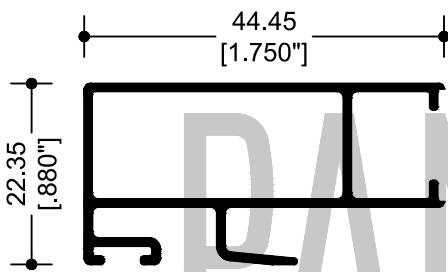

69955
TRASLAPE PUERTA

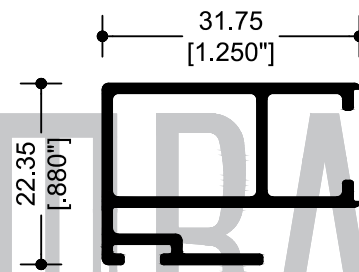

39954
TRASLAPE VENTANA

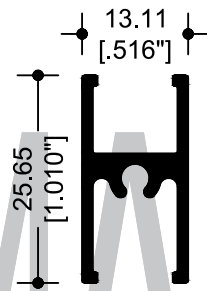

11203
INTERMEDIO PARA CUADRÍCULA

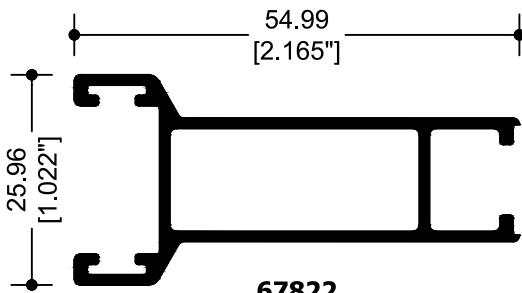

67822
CERCO OXXO PUERTA

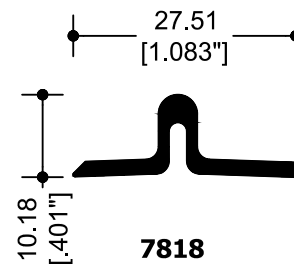

7818
ADAPTADOR XX

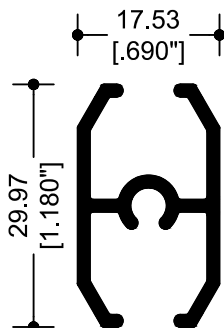

63728
PARA CUADRÍCULA RECERCADO 2"

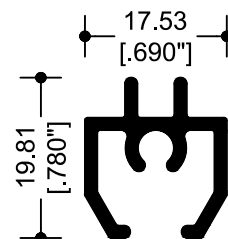

63727
BARROTILLO 2"

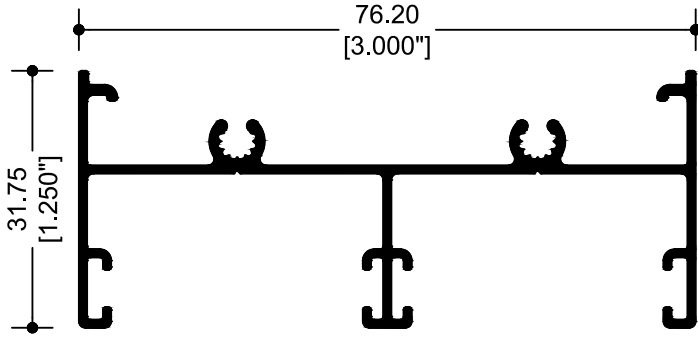

67826
CABEZAL Y JAMBA

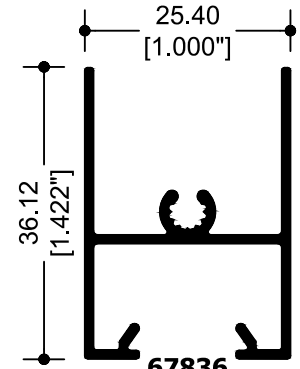

67836
CABEZAL VENTANA

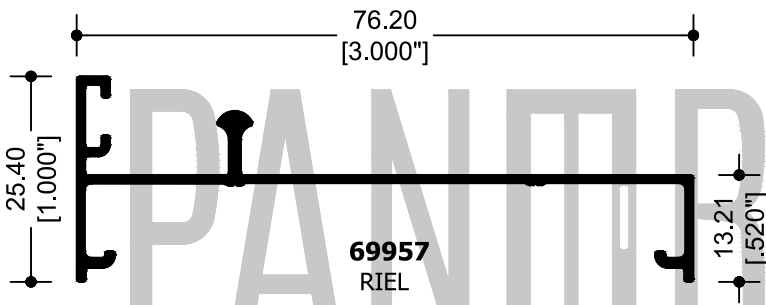

69957
RIEL

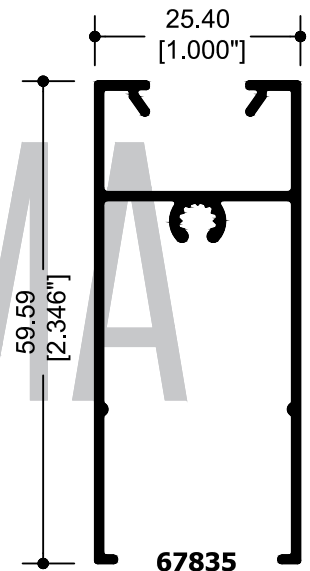

67835
ZOCLO VENTANA

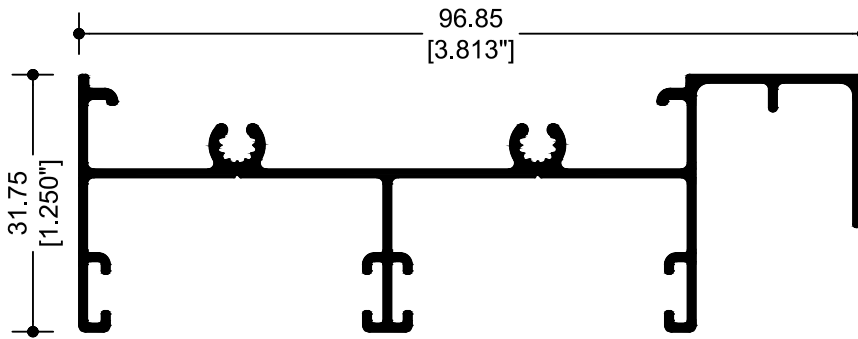

27862-77862
CABEZAL MOS. CORREDIZO

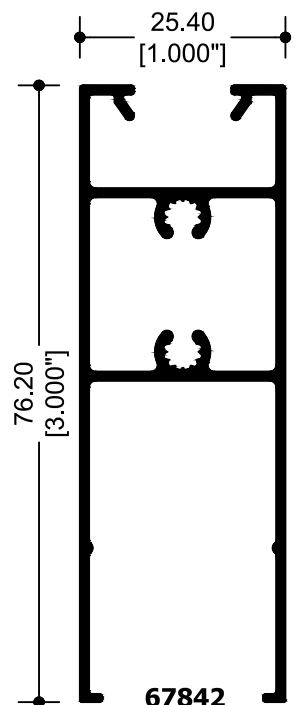

67842
ZOCLO PUERTA

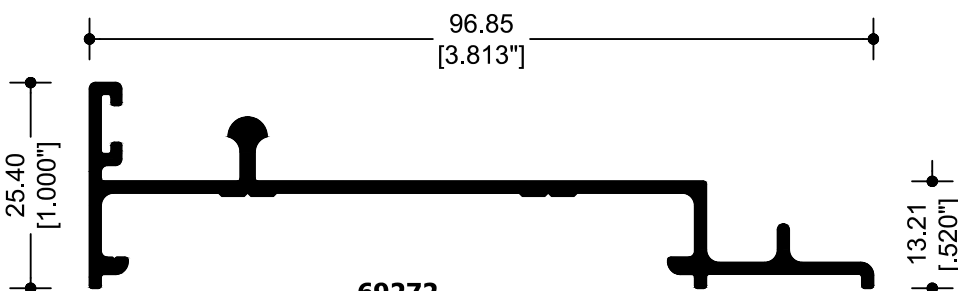

69272
RIEL PARA MOS. EXT. CORREDIZO

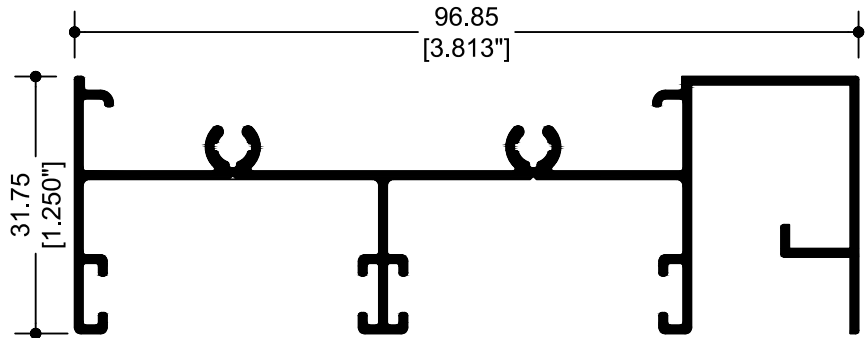

67862
CABEZAL MOSQUITERO COLGANTE

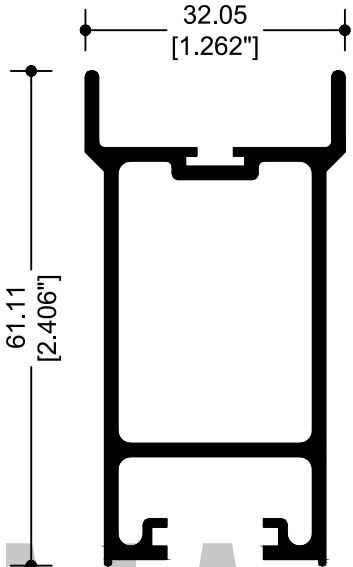

67850
CERCO OXXO

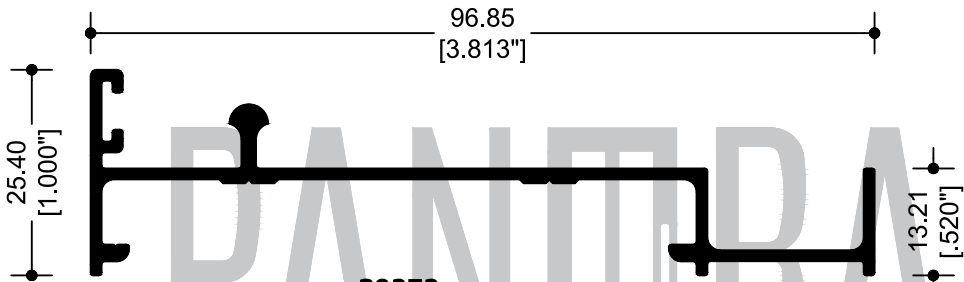

39272
RIEL PARA MOS. EXT. CORREDIZO

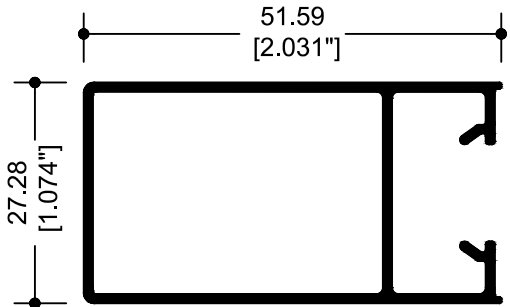

67847
CERCO CHAPA PUERTA

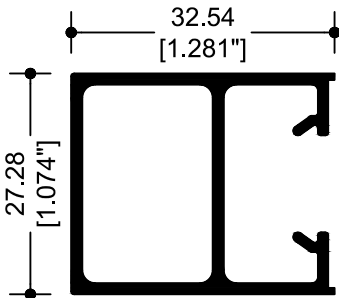

67843
CERCO VENTANA

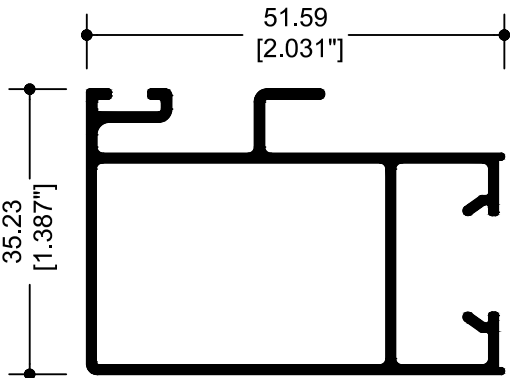

67848
TRASLAPE PUERTA

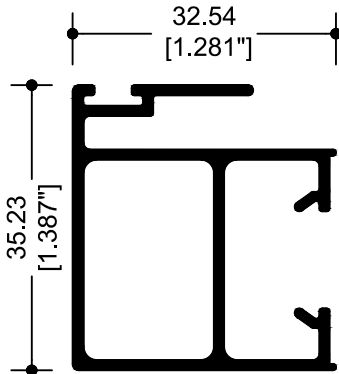

67844
CERCO TRASLAPE VENTANA

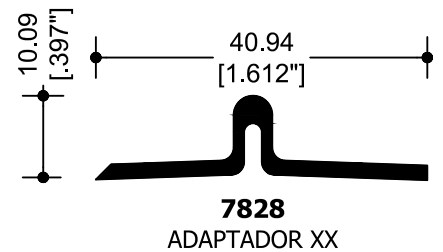
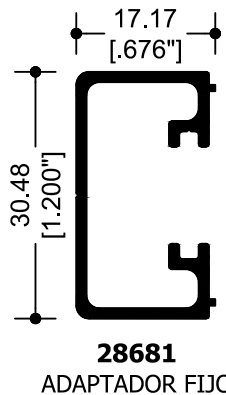
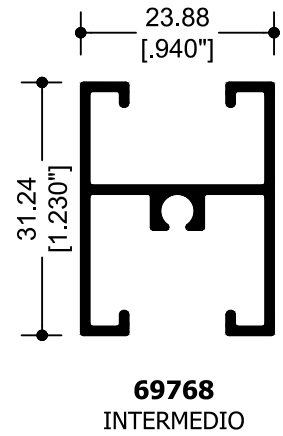
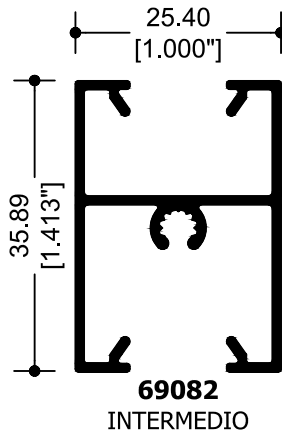
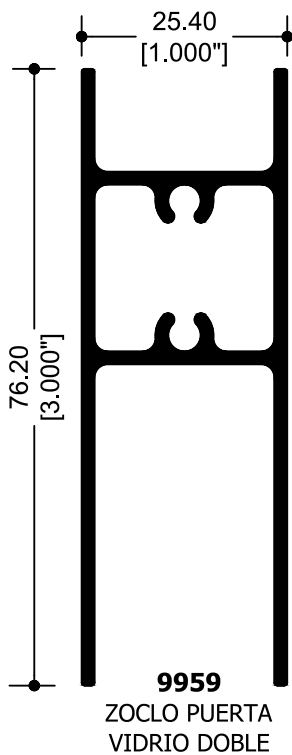
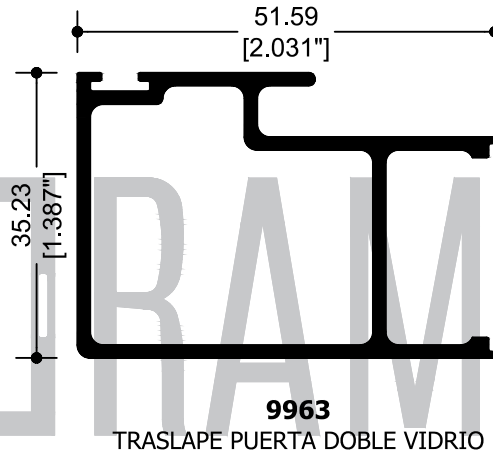
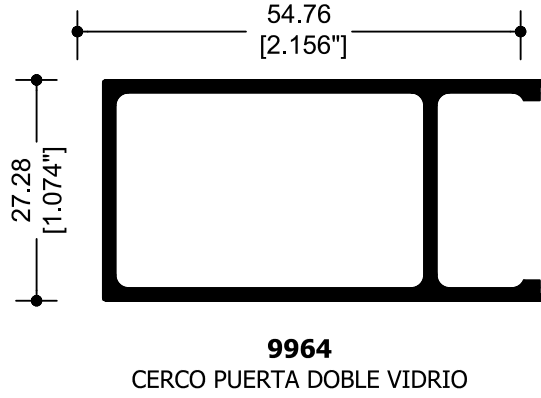
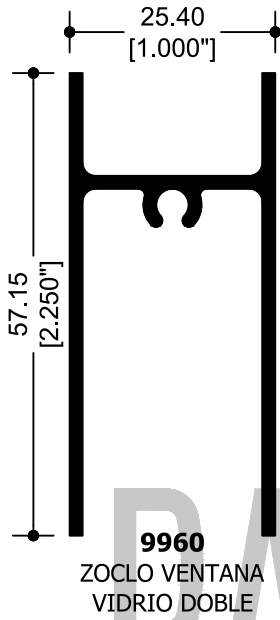

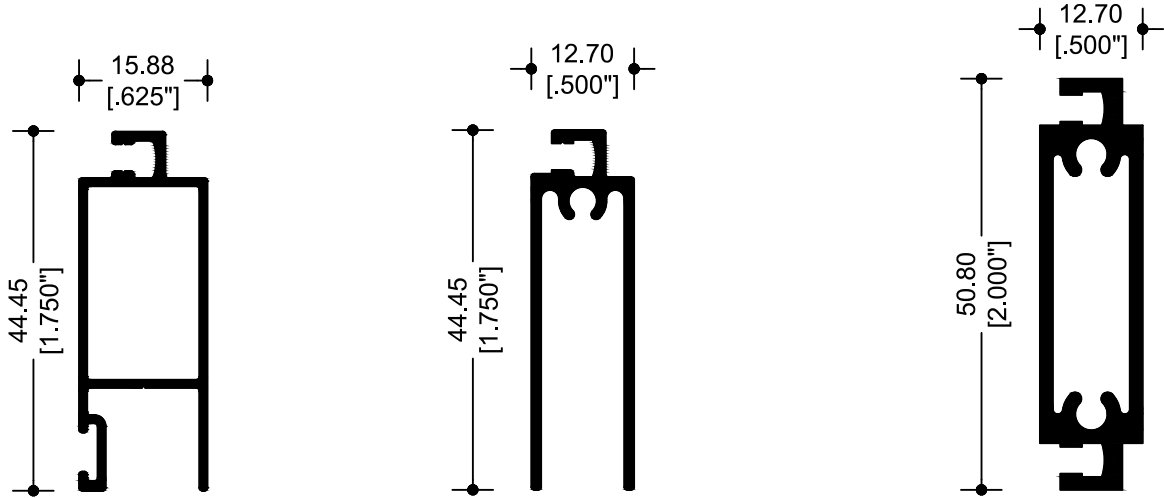

66534
CERCO MOSQUITERO

66533
CABEZAL Y ZOCLO
MOSQUITERO

7101
MOSQUITERO
INTERMEDIO

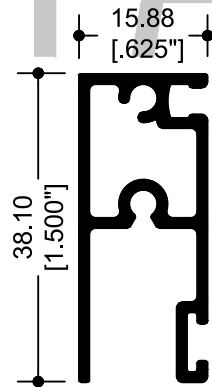

10358
MOSQUITERO

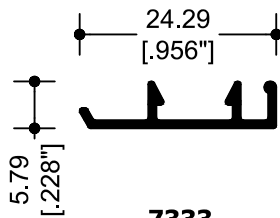

7333
MOSQUITERO

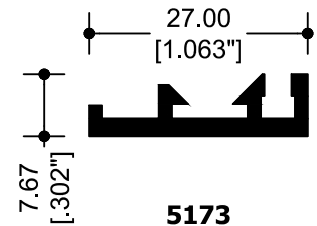

5173
MOSQUITERO

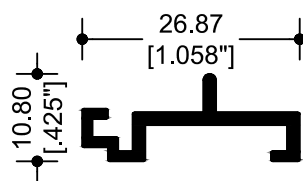

9966
ADAPTADOR MOSQUITERO

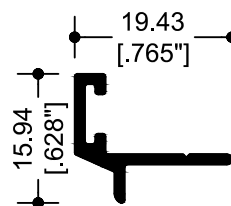

10220
ADAPTADOR OXXO

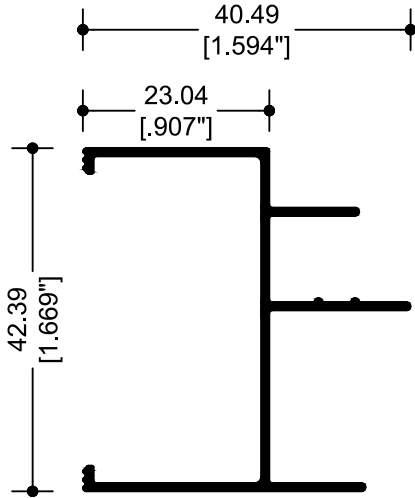

10570
JAMBA

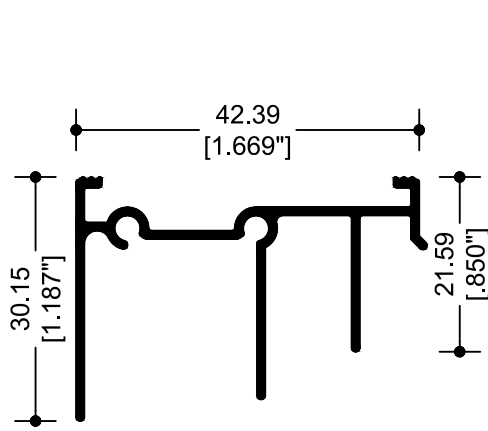

10568
CABEZAL

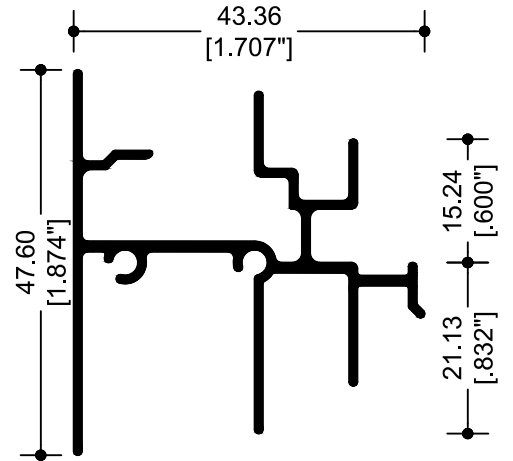

12797
RIEL Y CABEZAL

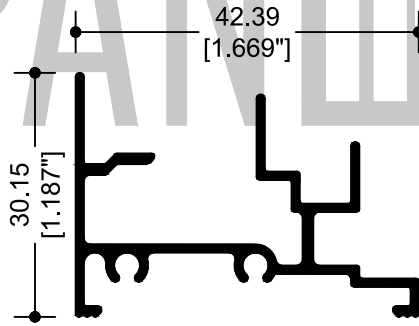
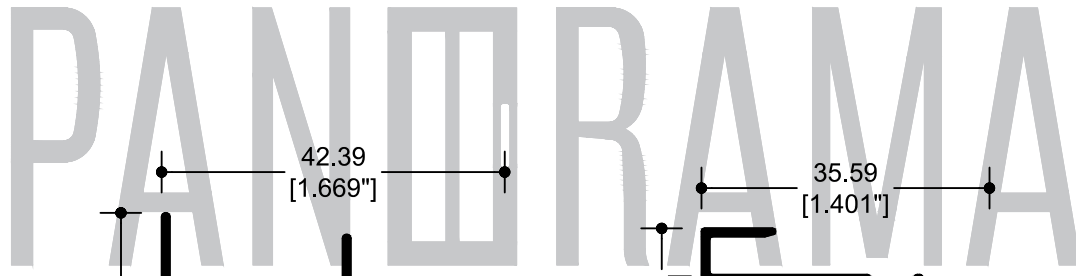

20569
RIEL

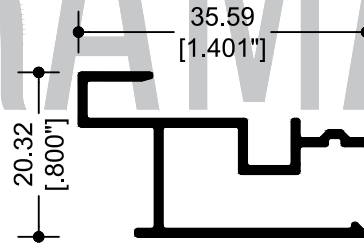

19272
TRASLAPE

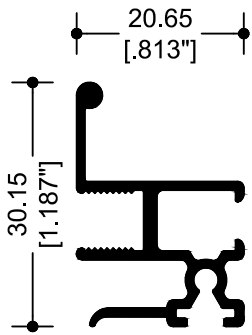

10571
CERCO MÓVIL

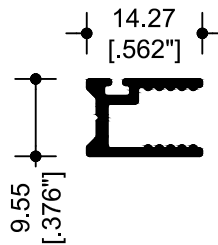

10574
CERCO FIJO

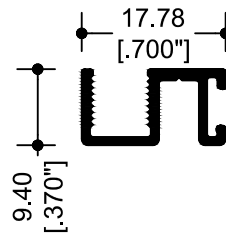

20572
CERCO Y ZOCLO

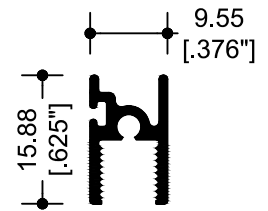

10575
ZOCLO

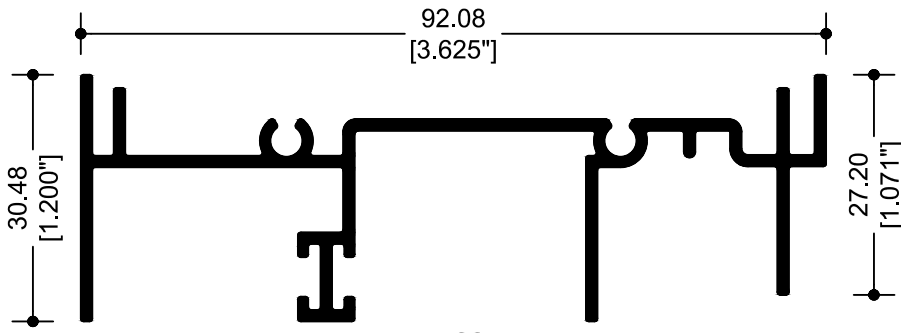

7109
CABEZAL CONTRAMARCO CORREDIZA

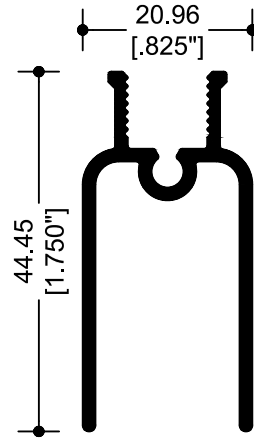

7108
CABEZAL Y ZOCLO

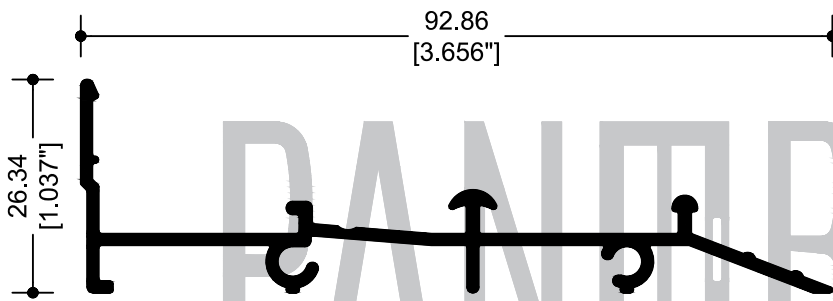

7110
RIEL CONTRAMARCO CORREDIZO

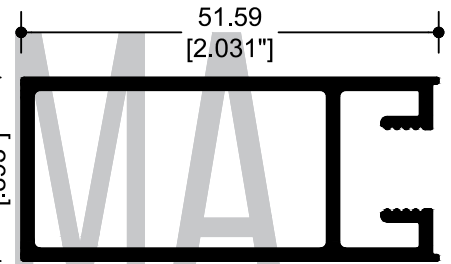

7105
CERCO CHAPA

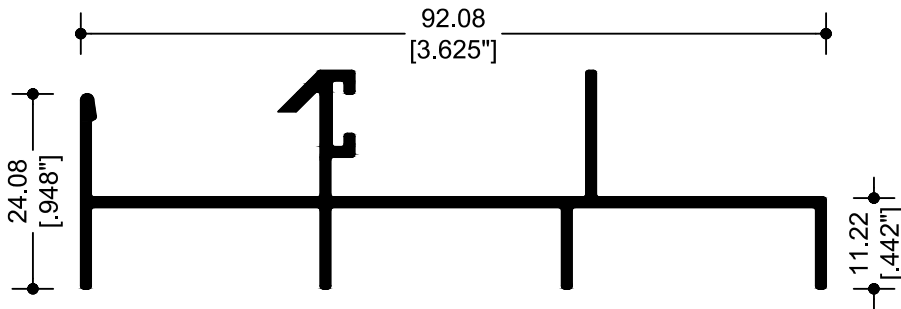

27111
JAMBA PARA CORREDIZA

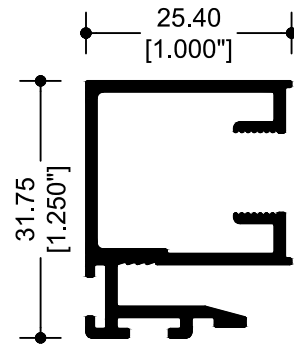

7106
CERCO TRASLAPE

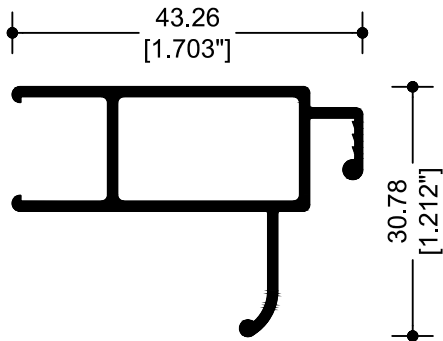

7112
VERTICAL MOSQUITERO

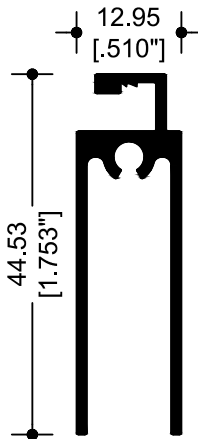

7104
MOSQUITERO

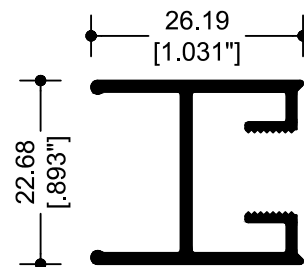

7107
CERCO FIJO

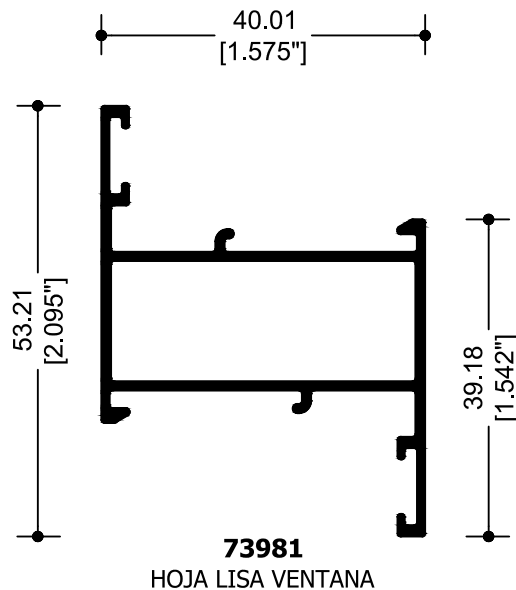
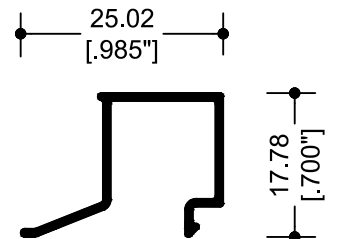
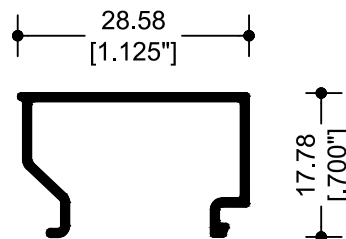
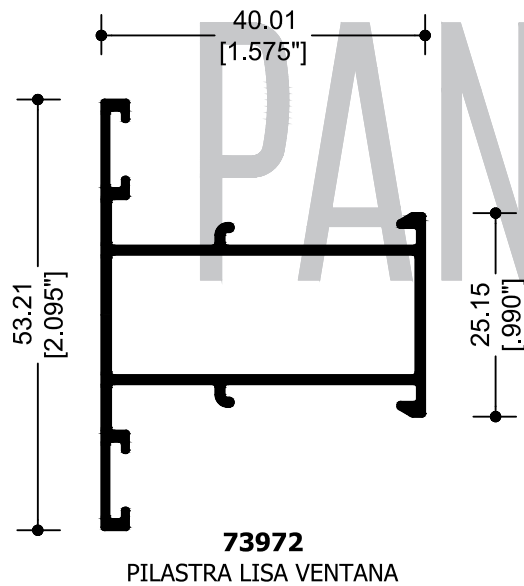
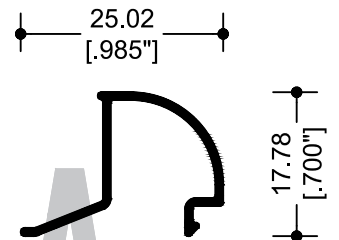
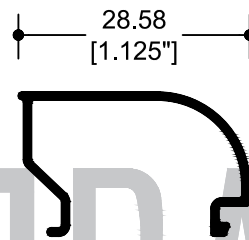
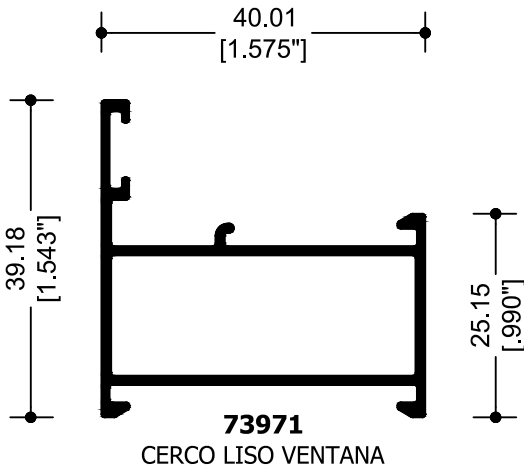

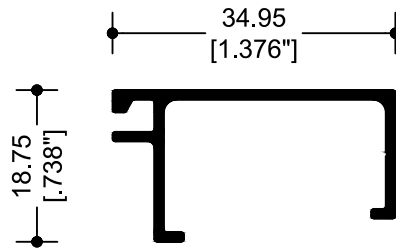

28939
JUNQUILLO

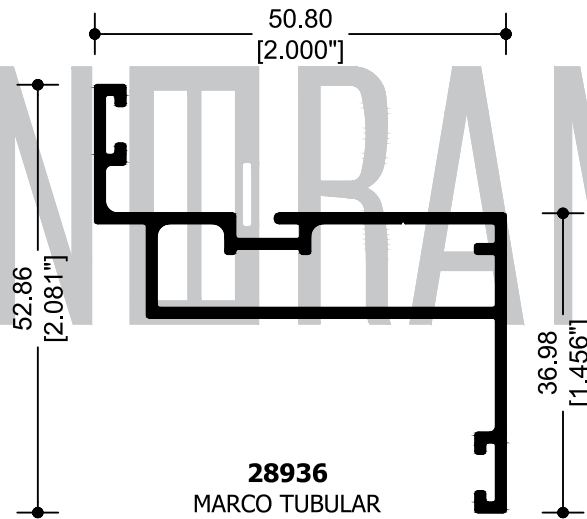

28936
MARCO TUBULAR

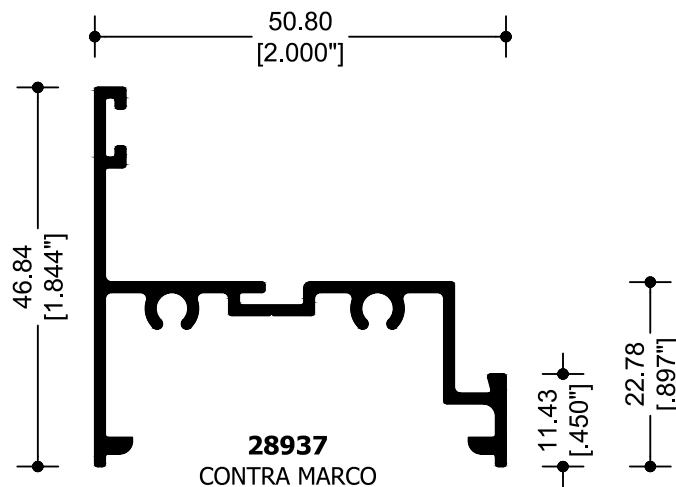

28937
CONTRA MARCO

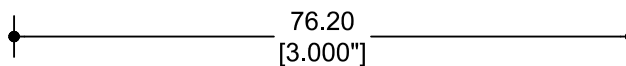
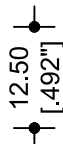
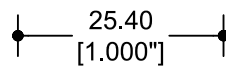
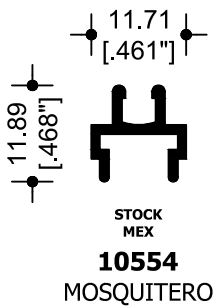
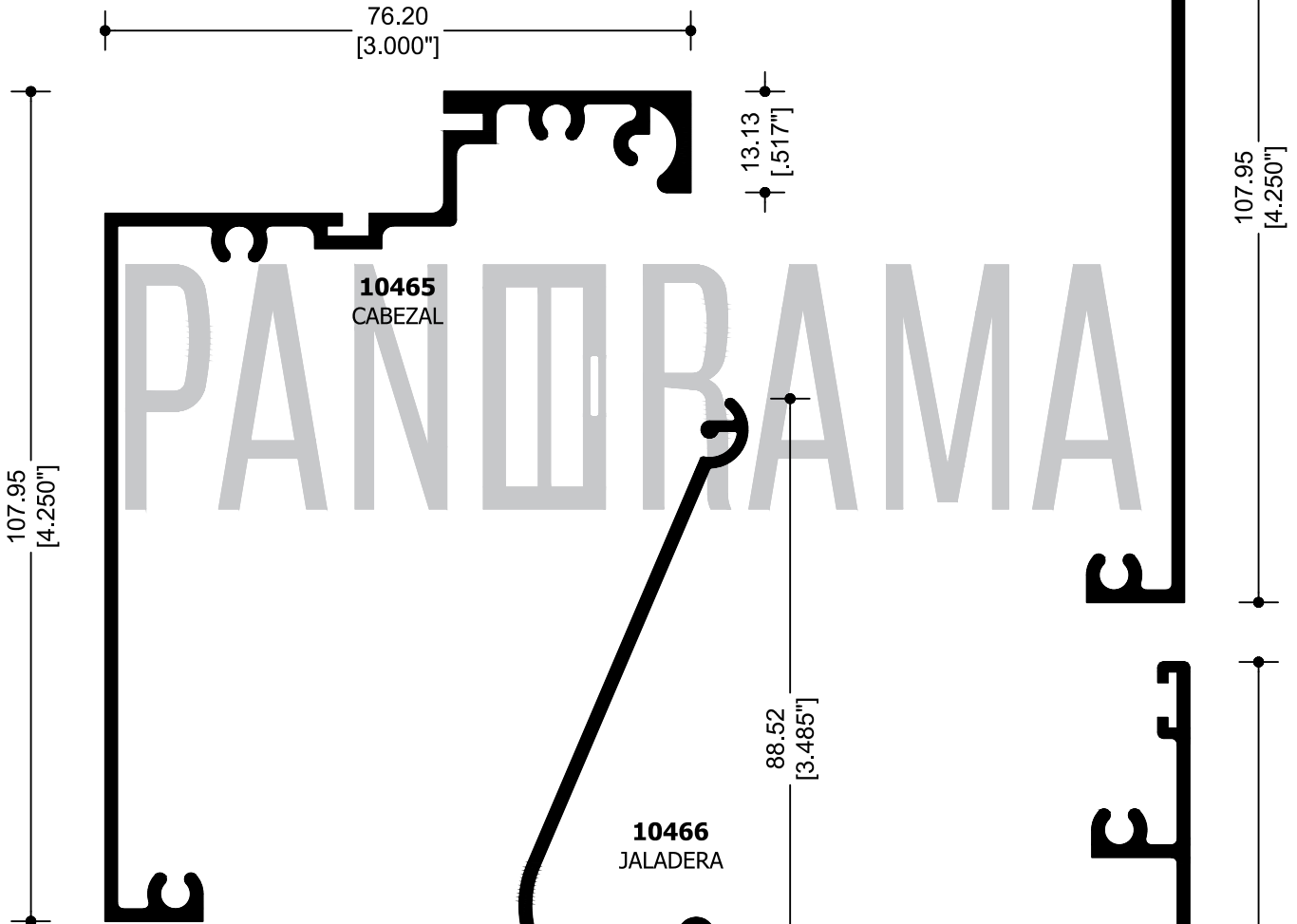
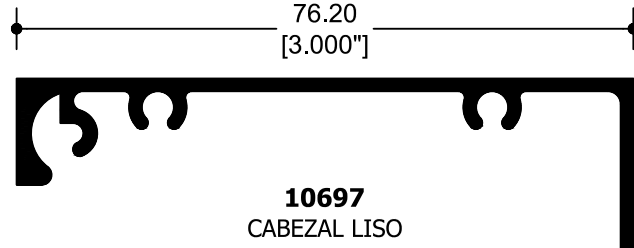
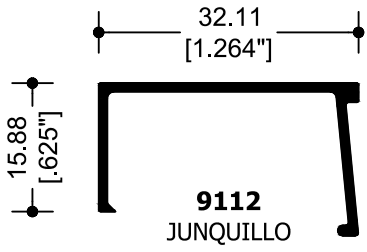

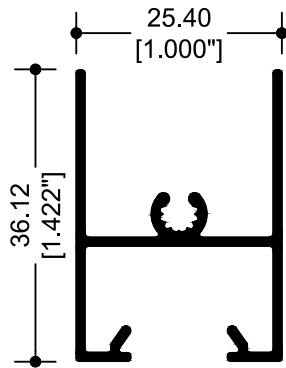

67836
CABEZAL

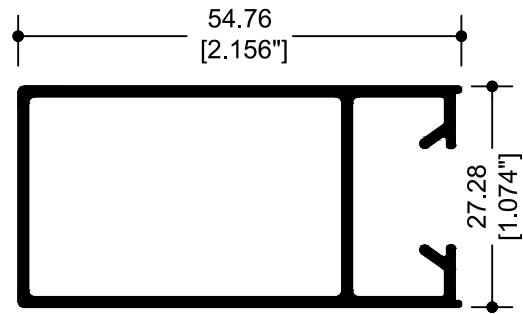

9236
CERCO CHAPA

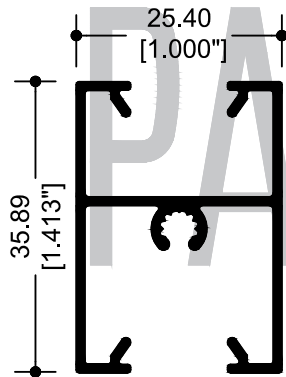

69082
INTERMEDIO

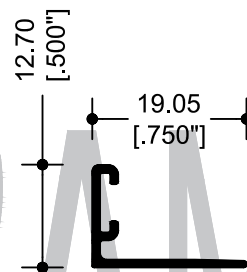

11032
BATIENTE

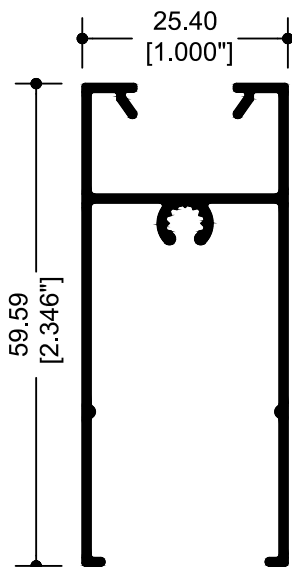

67835
ZOCLO

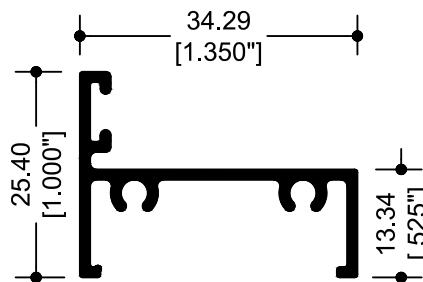

33087
MARCO PARA PUERTA

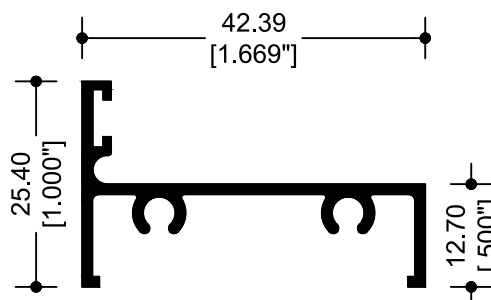

68550
MARCO PARA PUERTA

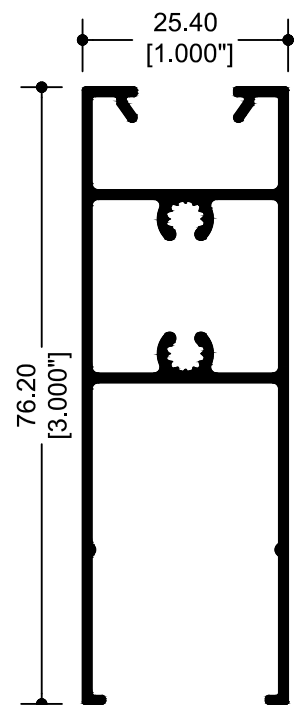

67842
ZOCLO

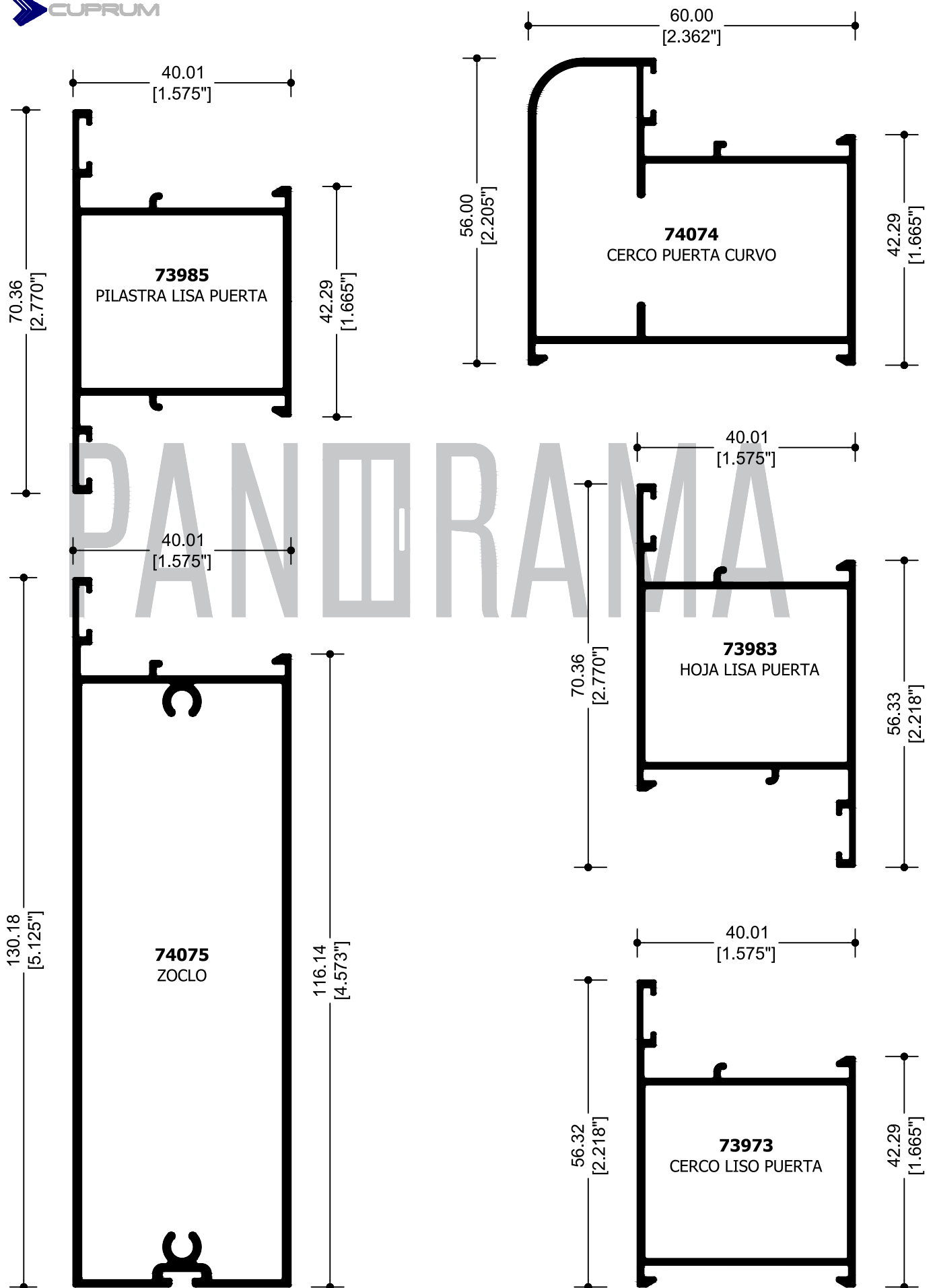

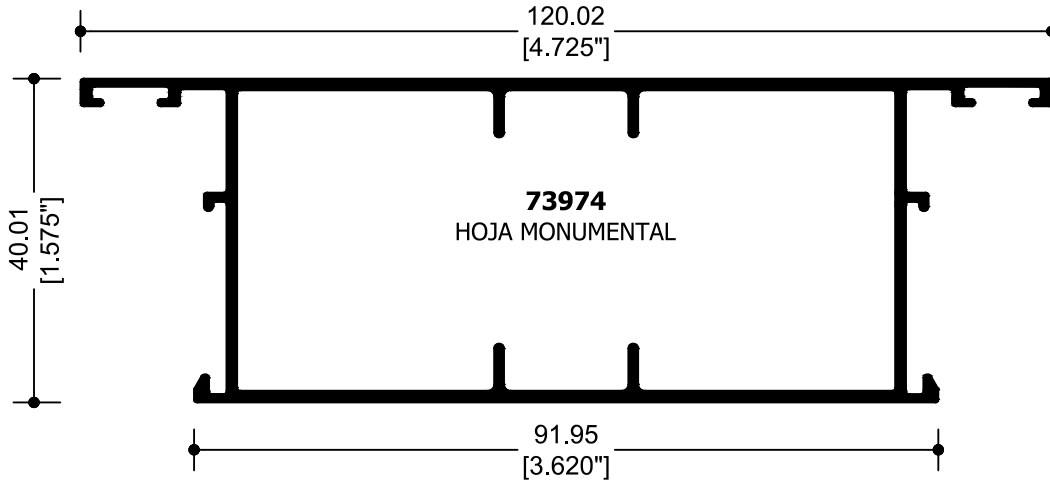

PANORAMA

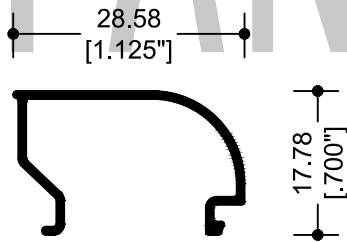

74073
JUNQUILLO REDONDO ANCHO

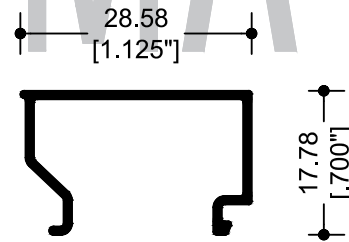

73978
JUNQUILLO ANCHO

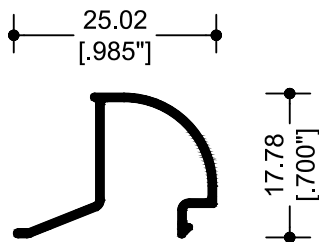

74634
JUNQUILLO REDONDO ESTRECHO

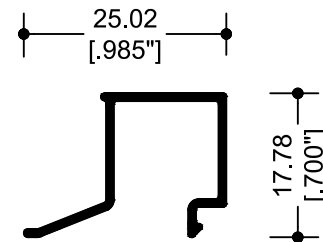

74635
JUNQUILLO ESTRECHO

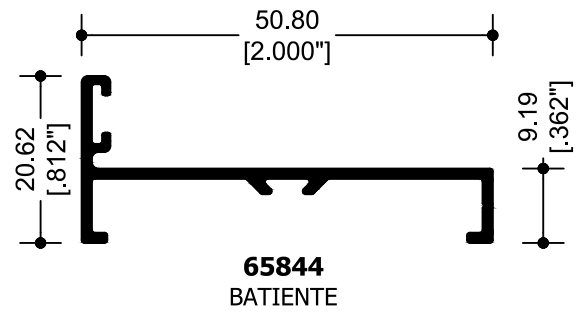
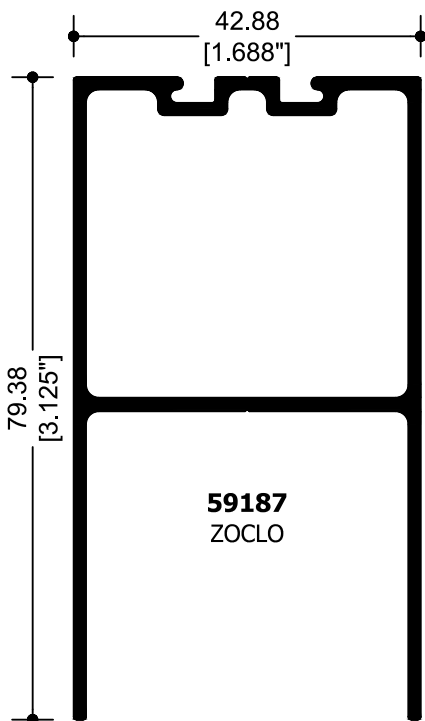
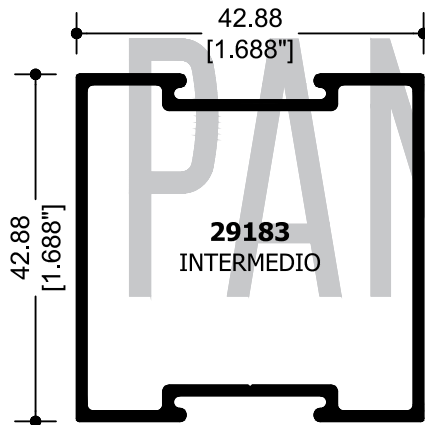
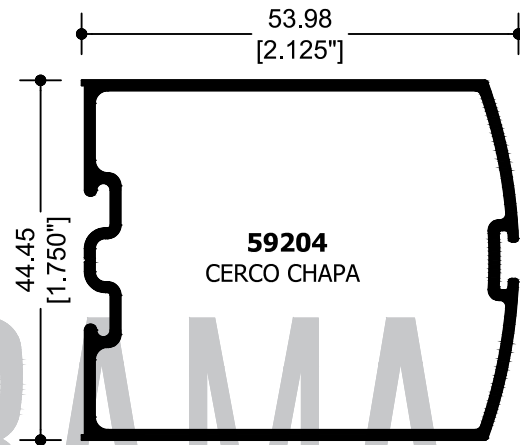
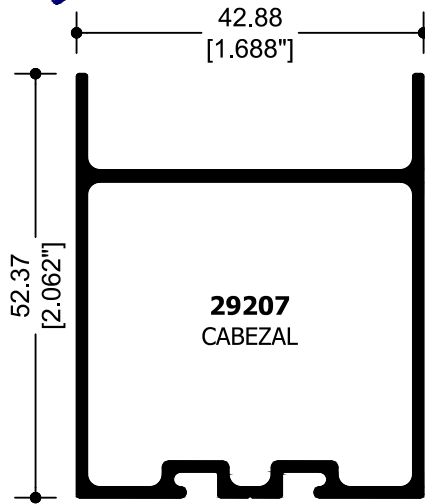

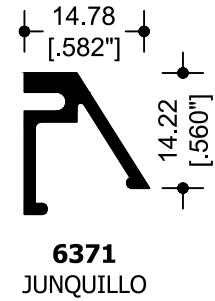
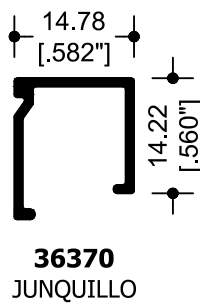
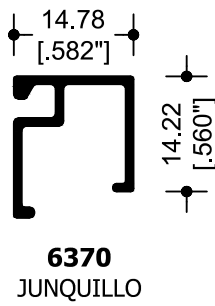
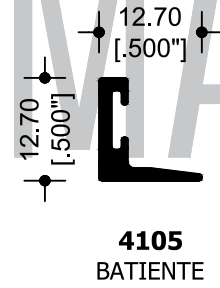
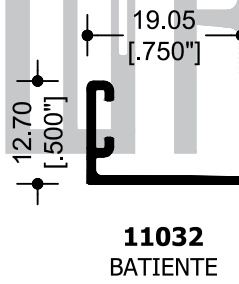
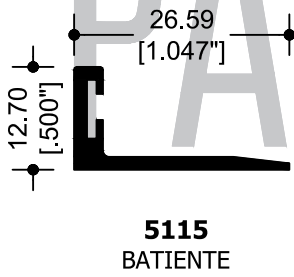
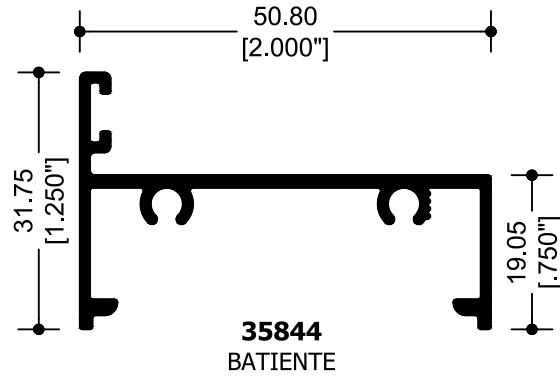

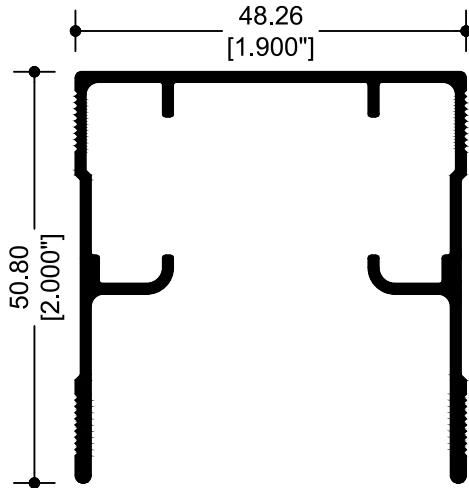

9947
RIEL SUPERIOR

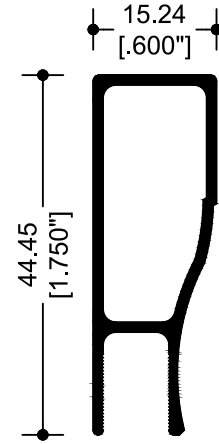

9756
MARCO 1 3/4"

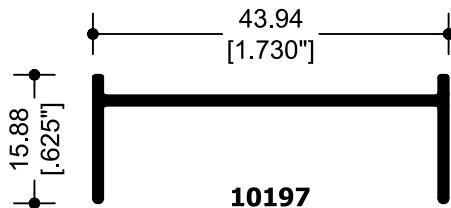

10197
JAMBA LATERAL

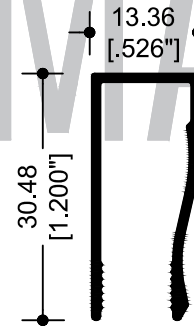

13563
MARCO 1 1/4"

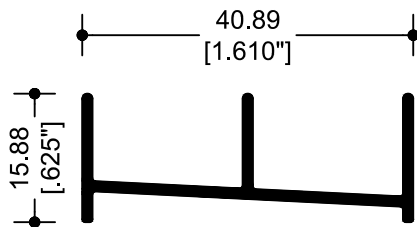

10198
RIEL INFERIOR

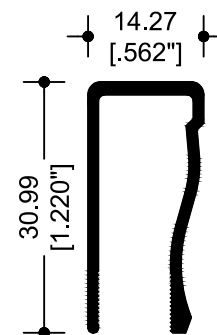

9525
MARCO 1 1/4"

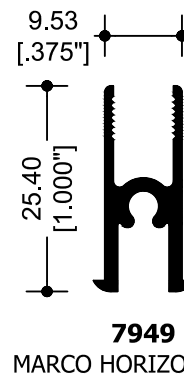
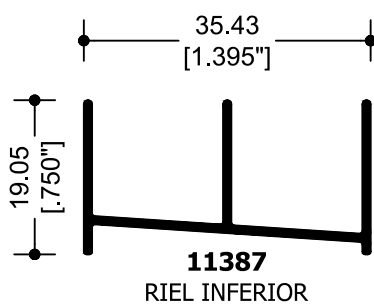
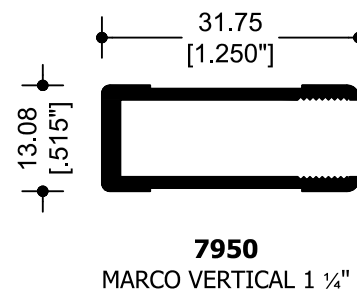
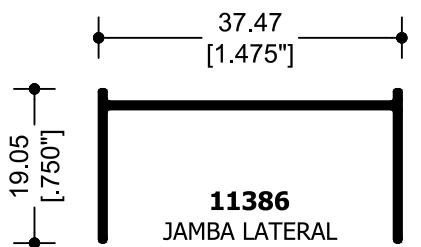
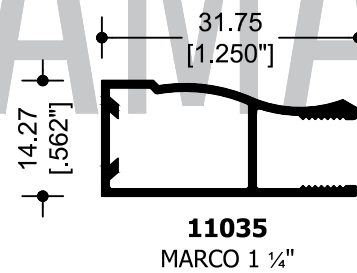
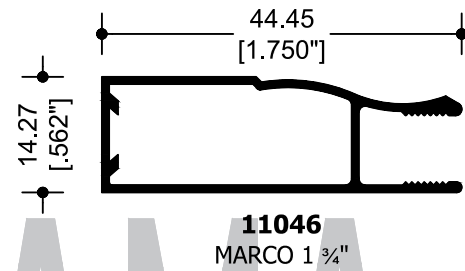
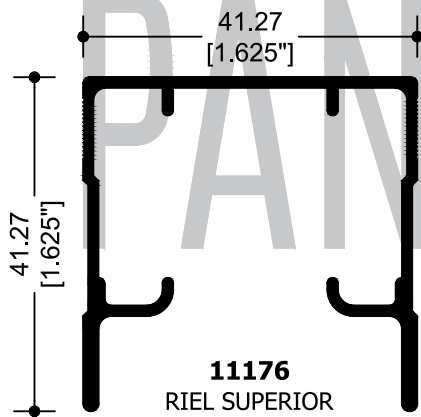
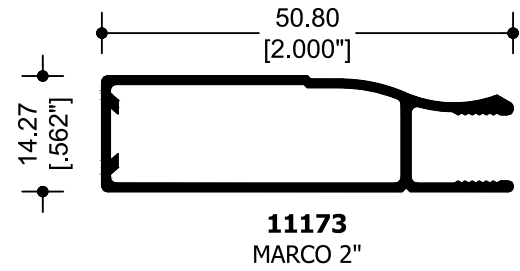
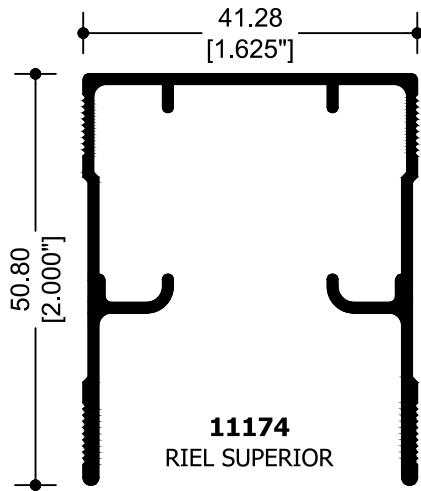

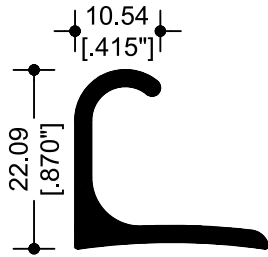

4154
JALADERA

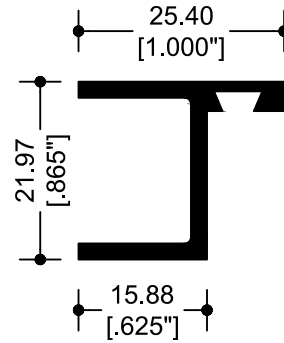

7102
BATIENTE



APARADORES Y VITRINAS

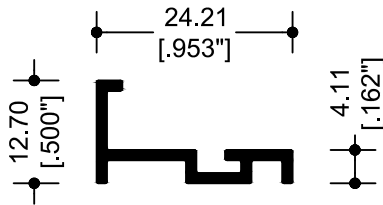

67013
BASE

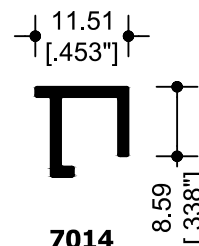

7014
JUNQUILLO

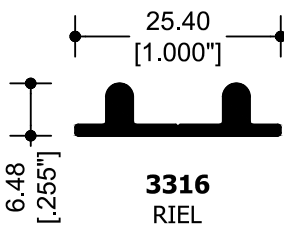

3316
RIEL

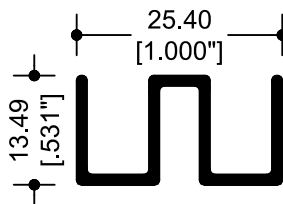

63329
GUÍA

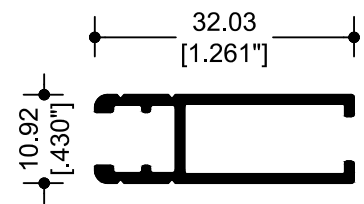

53358
ZAPATA

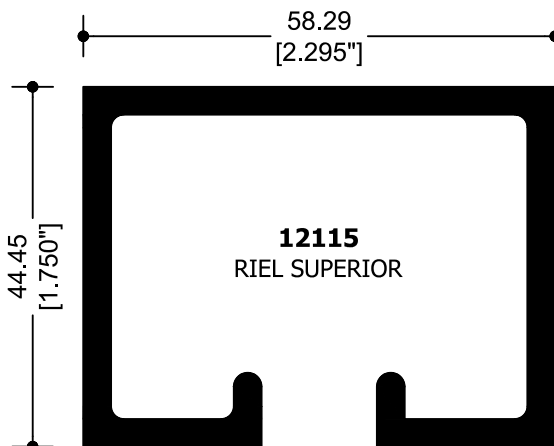
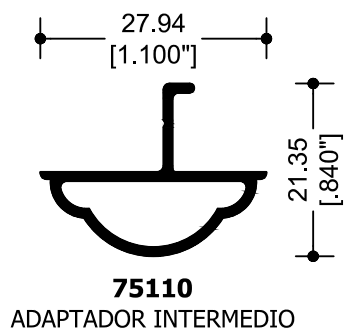
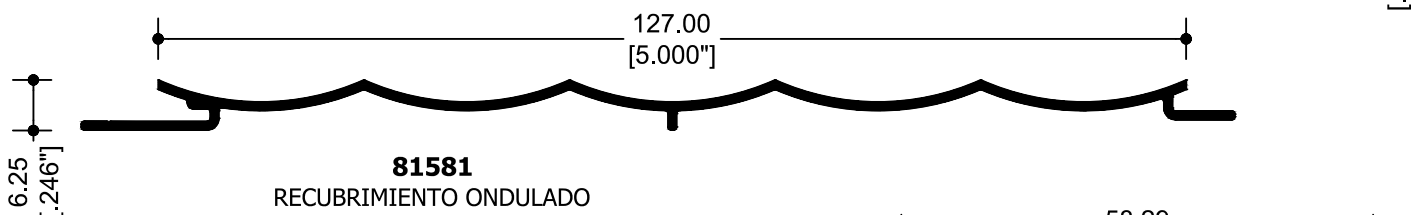
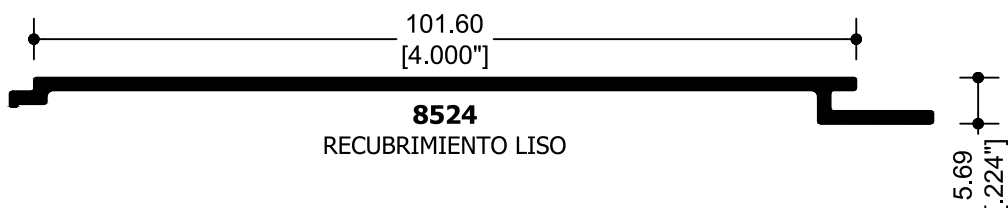
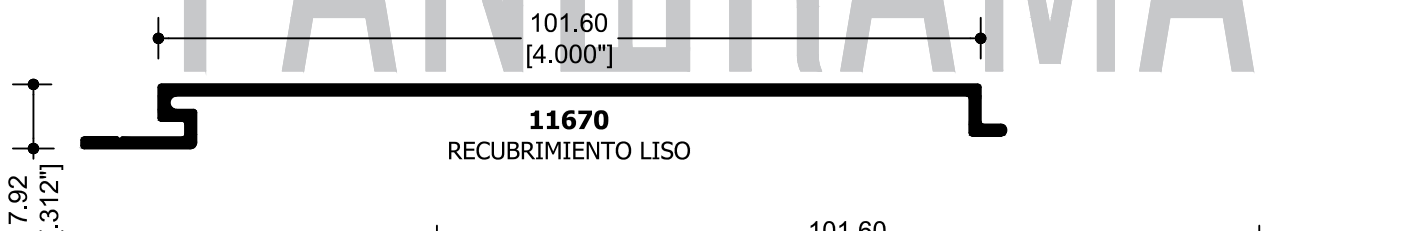
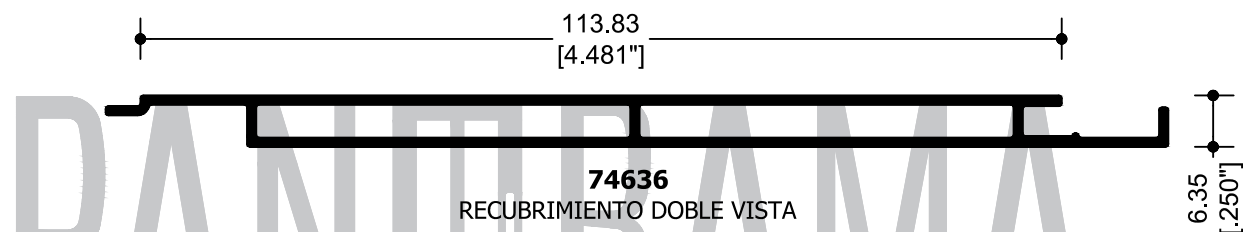
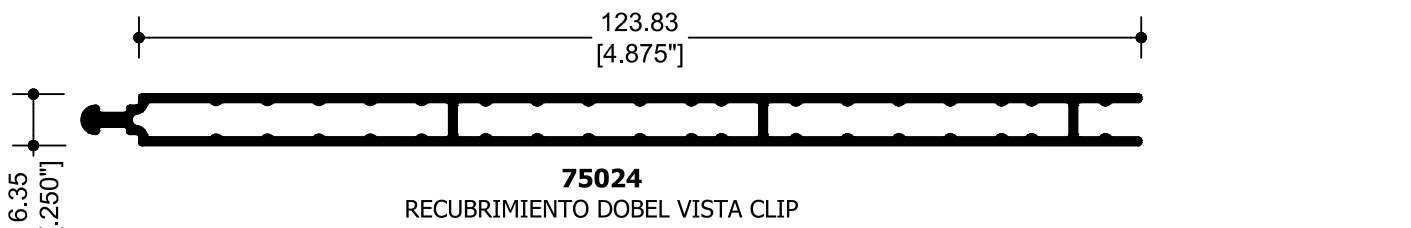
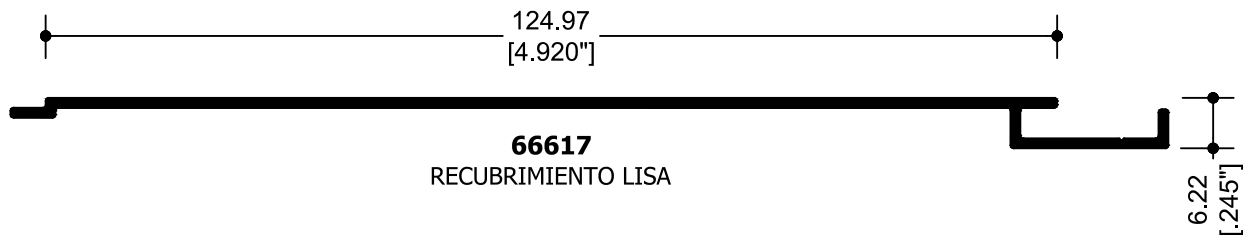

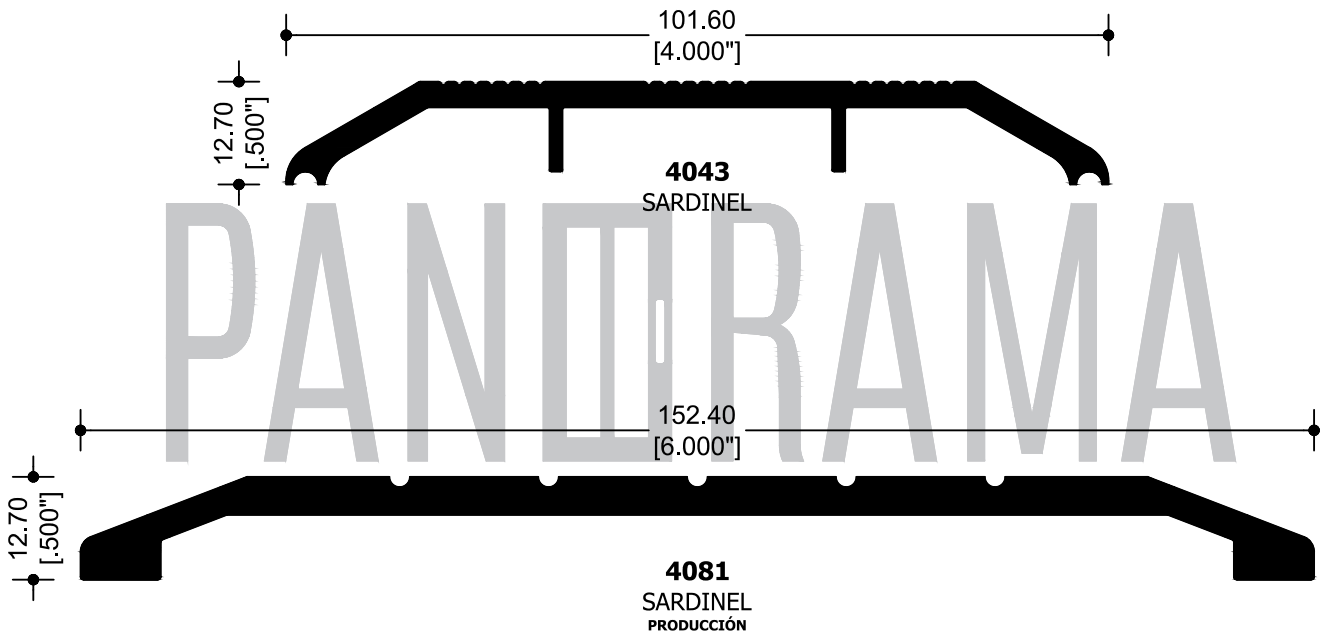
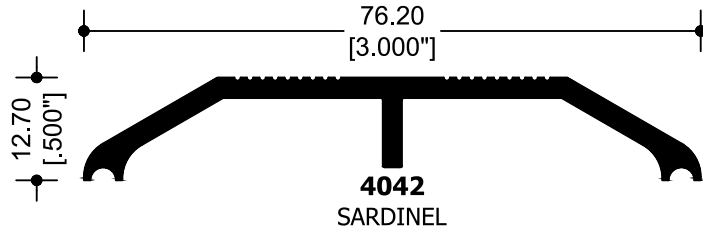

REPIZÓN

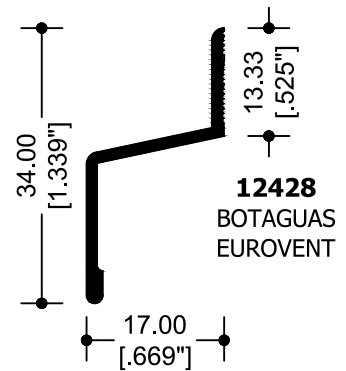
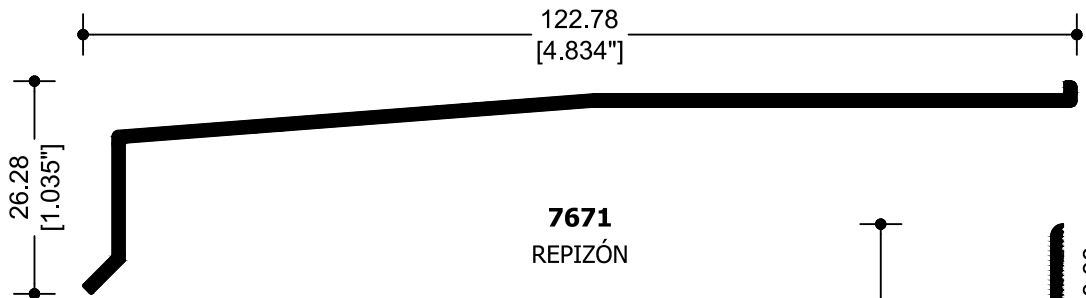

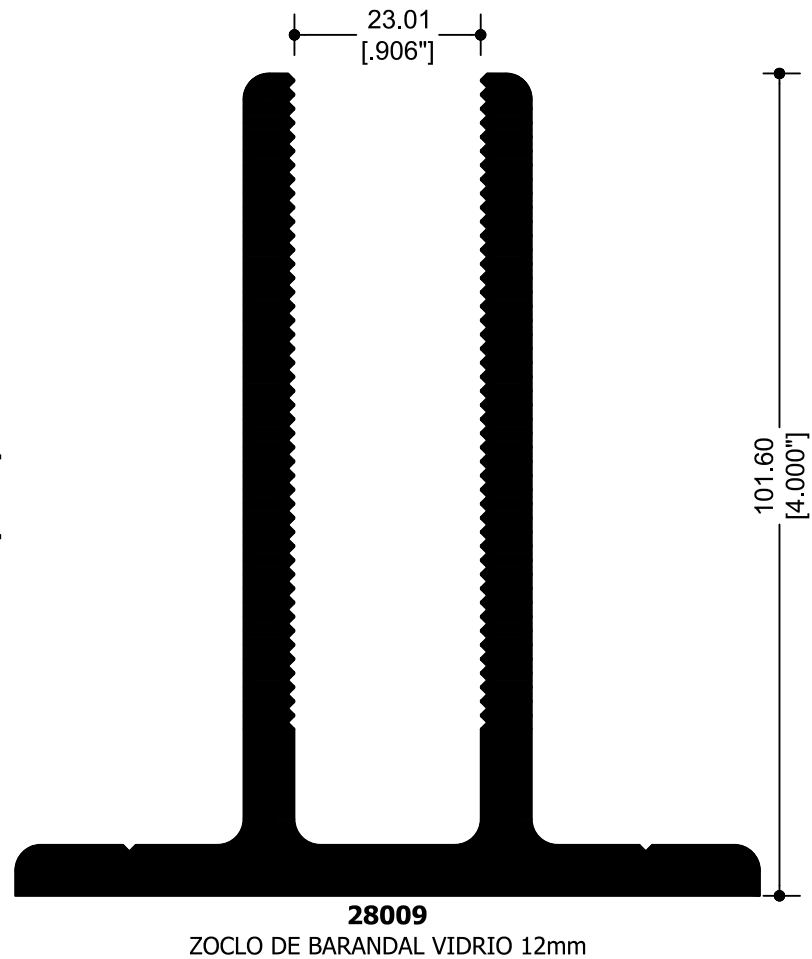
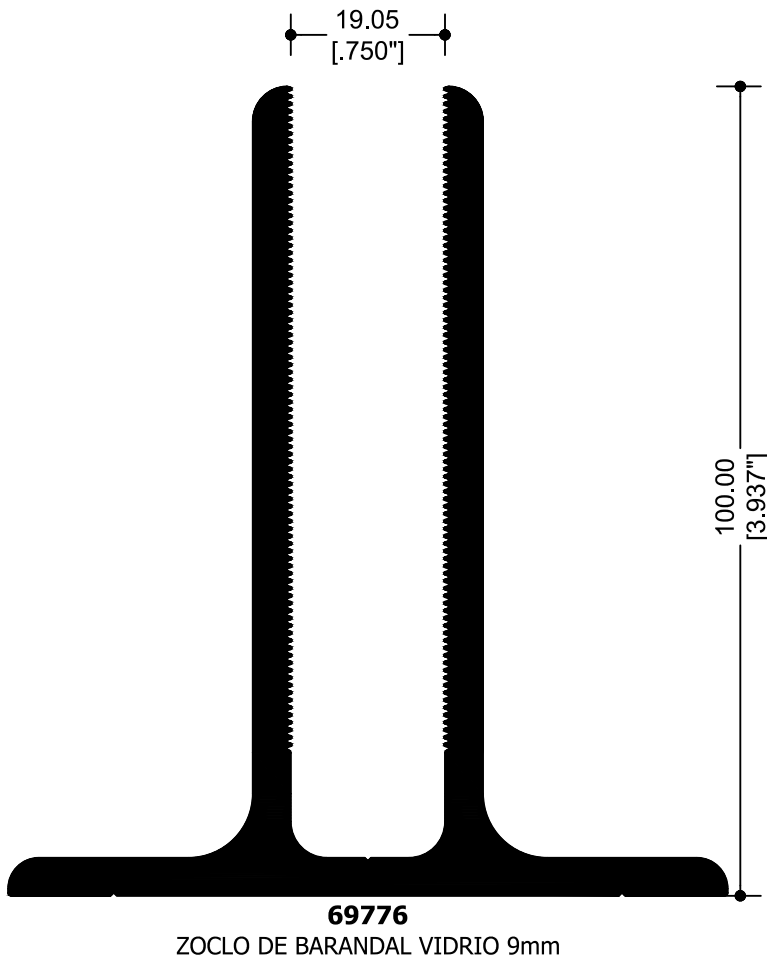
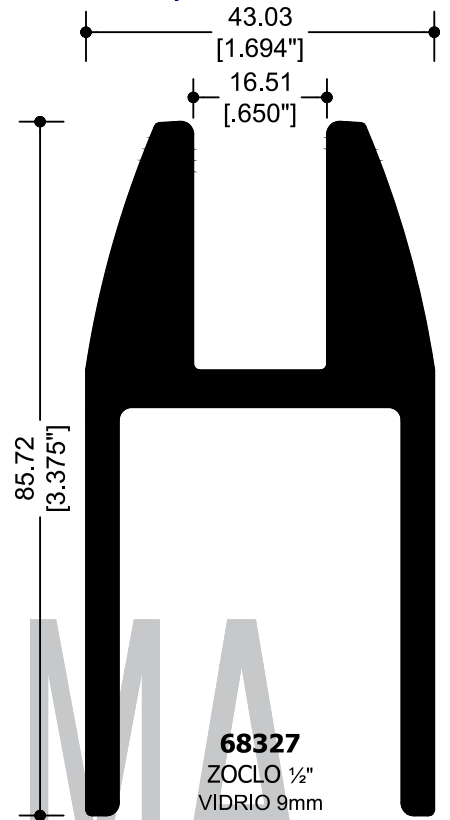
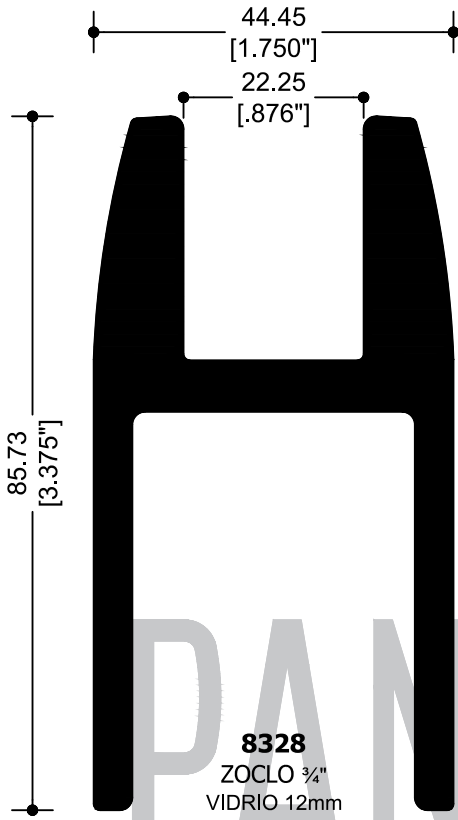

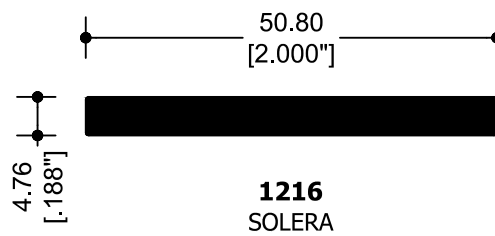
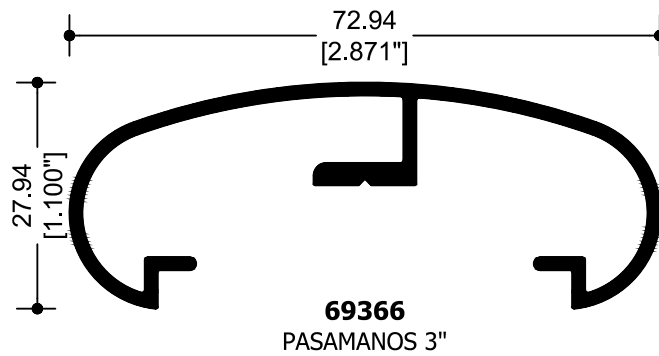
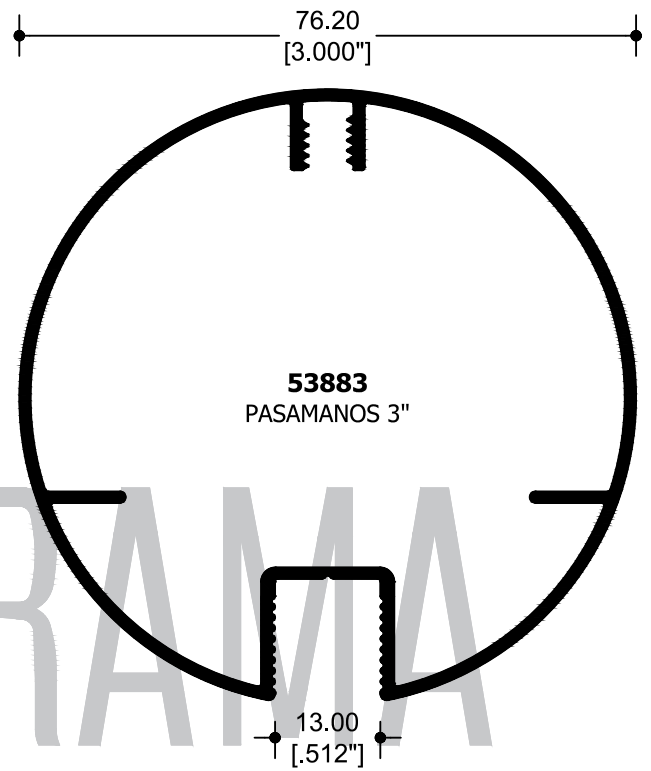

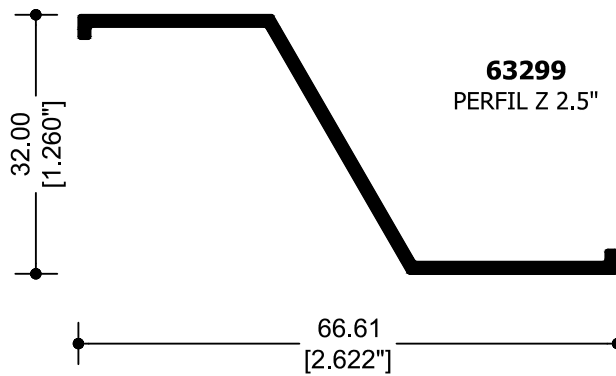
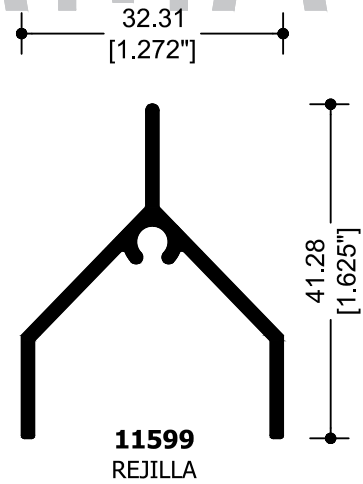
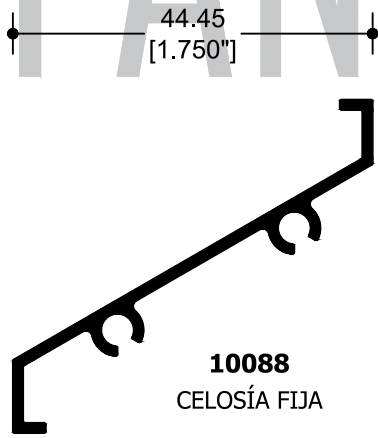
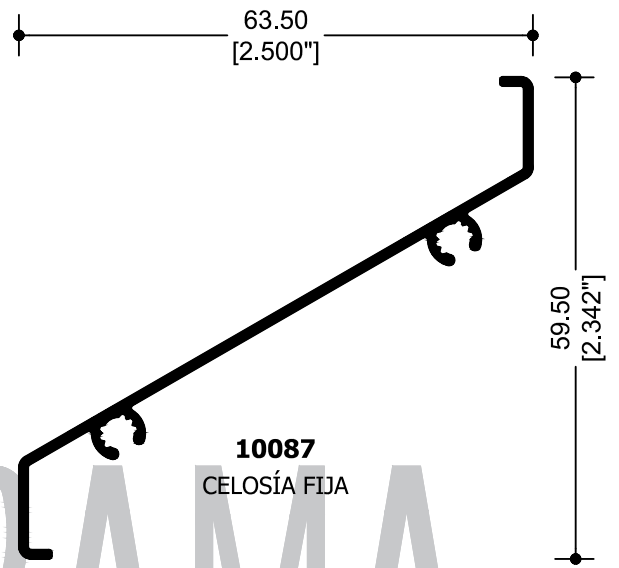
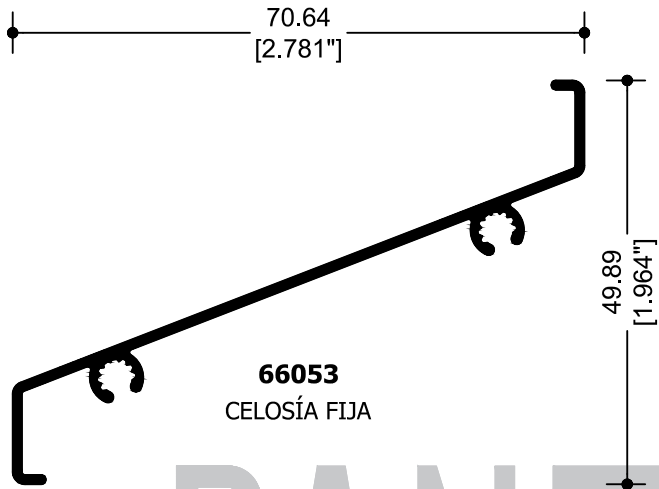

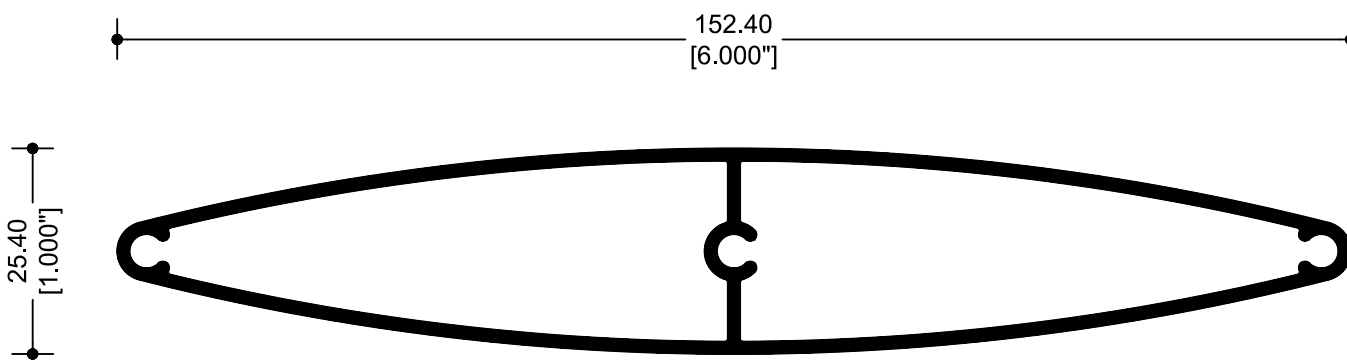
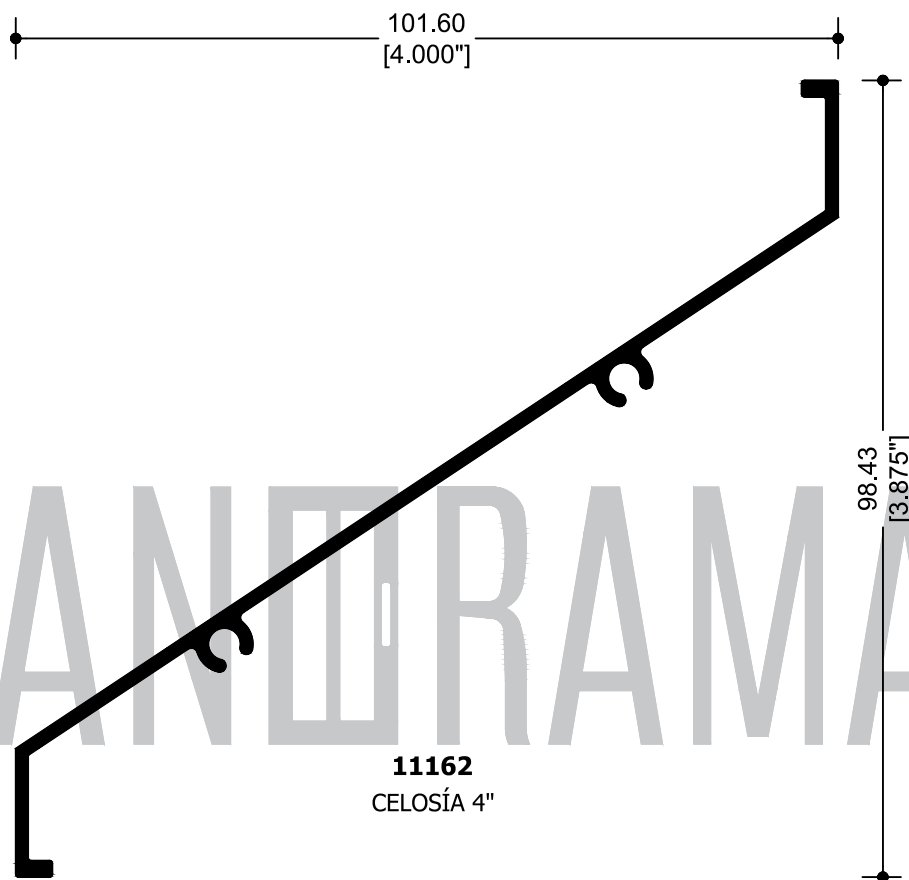

67362
CELOSÍA 6"
PRODUCCIÓN

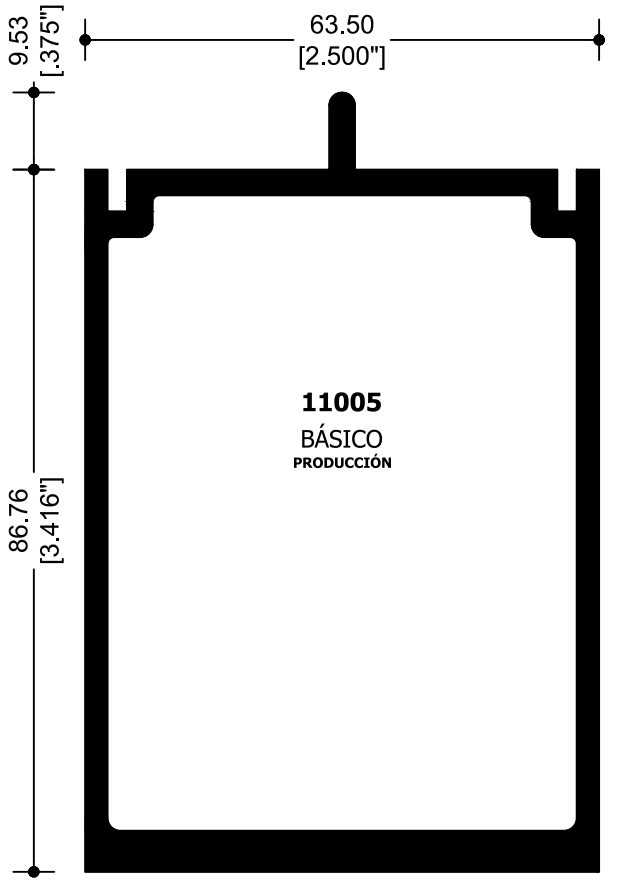
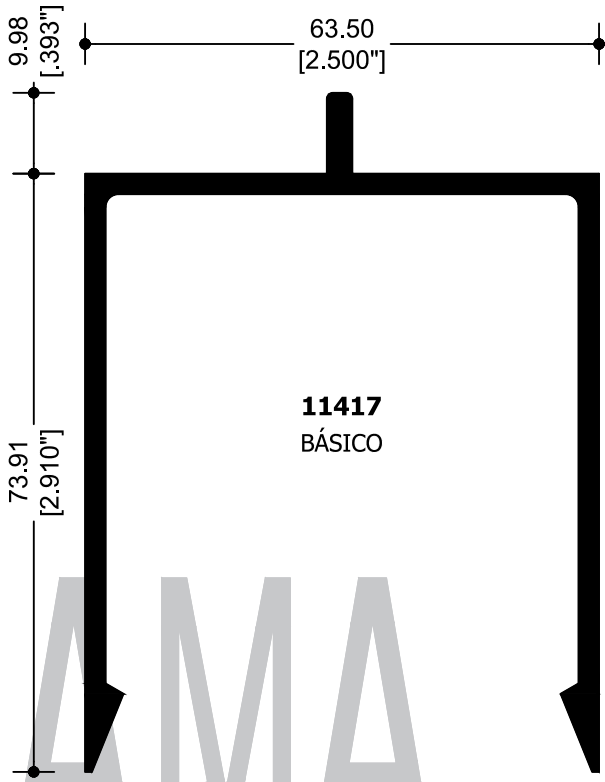
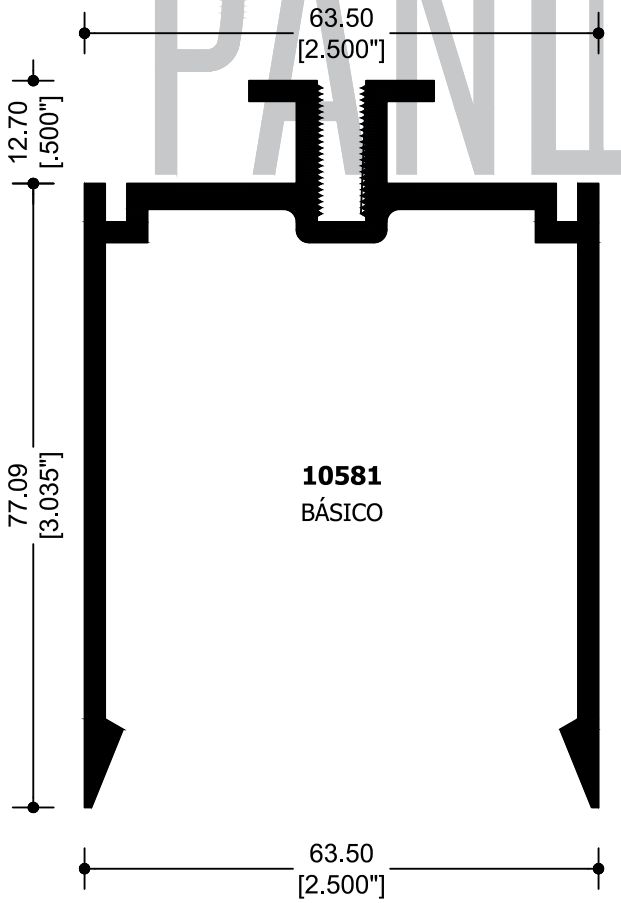
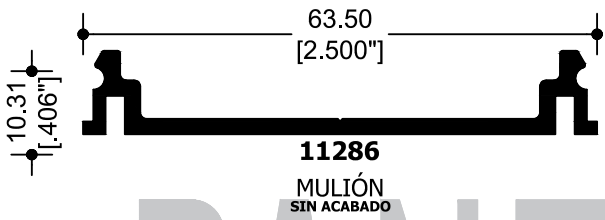
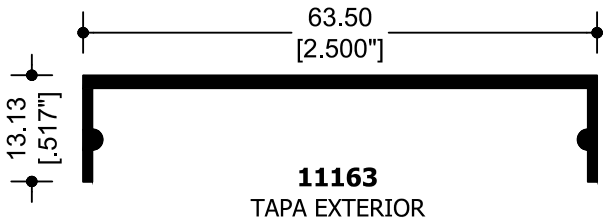

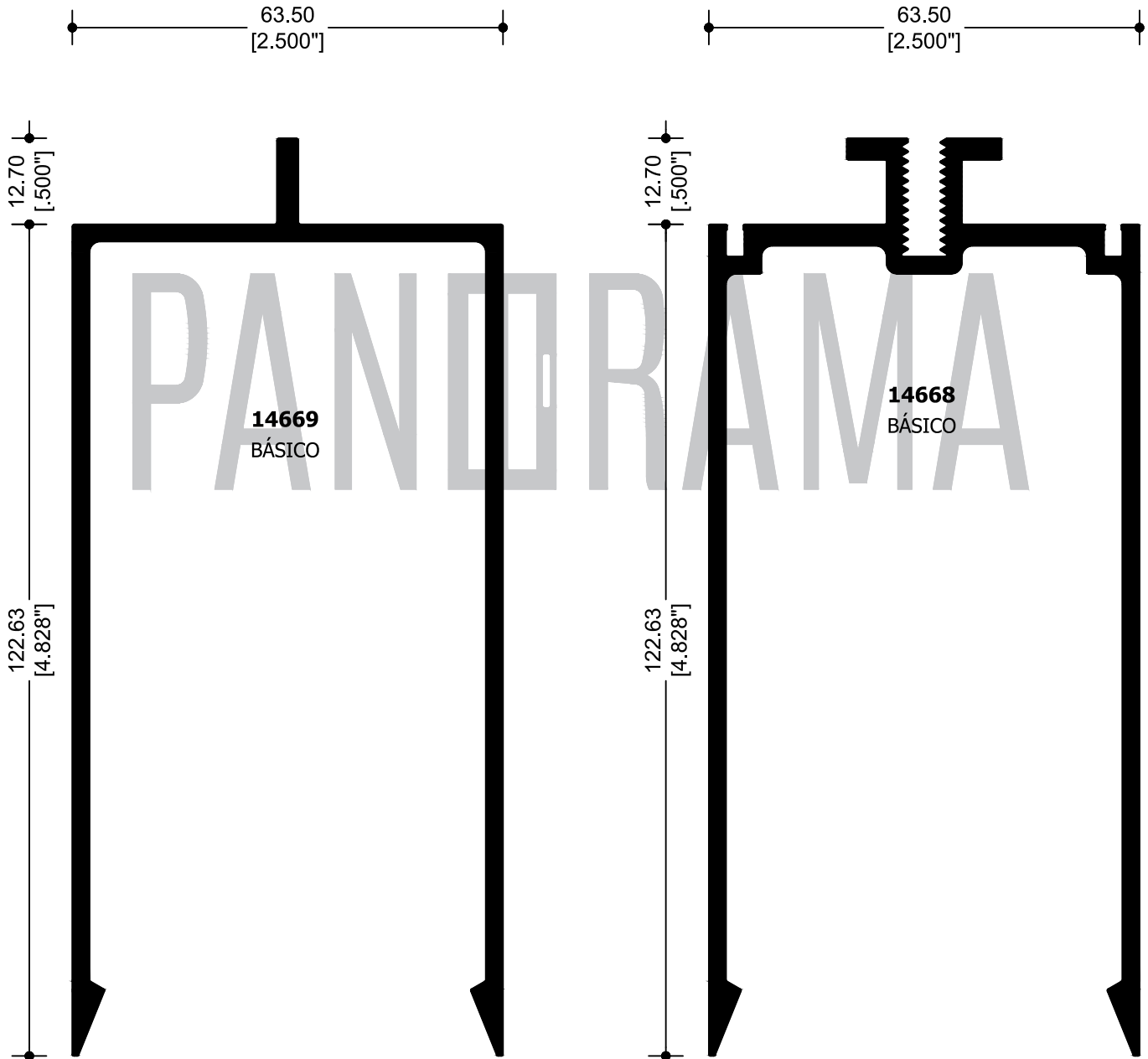

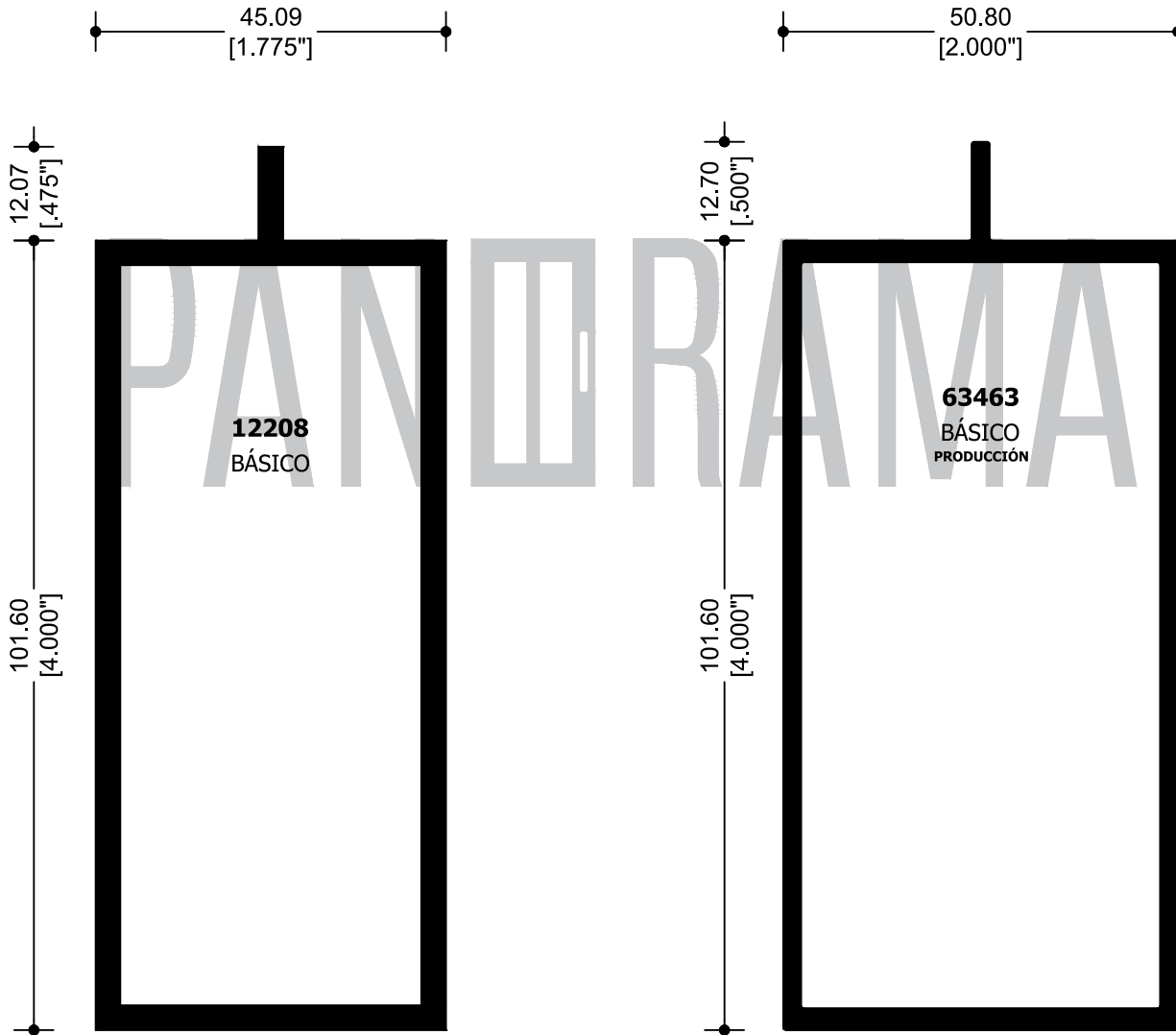

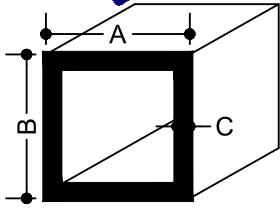

TUBO CUADRADO

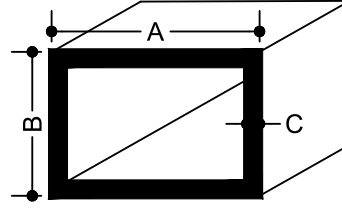

TUBO RECTANGULAR

CLAVE	MEDIDAS EN PULGADAS		
	A	B	C
50170	0.500	0.500	.050
2351	0.750	0.750	.050
22036	0.750	0.750	.062
62488	1.000	1.000	.039
11161	1.000	1.000	.045
2362	1.000	1.000	.050
11154	1.250	1.250	.049
2354	1.250	1.250	.065
62489	1.500	1.500	.044
2363	1.500	1.500	.057
22268	1.500	1.500	.125
11093	1.750	1.750	.050
2364	1.750	1.750	.057
11156	2.000	2.000	.054
2356	2.000	2.000	.065
2369	3.000	3.000	.058
2358	3.000	3.000	.083
2365	4.000	4.000	.125

CLAVE	MEDIDAS EN PULGADAS		
	A	B	C
52500	1.000	0.500	.048
22049	1.000	0.500	.062
62515	1.500	0.750	.045
2515	1.500	0.750	.050
2514	1.500	1.000	.062
62521	2.000	1.000	.044
2521	2.000	1.000	.057
11099	2.500	1.250	.055
65321	3.000	1.000	.052
22242	3.000	1.000	.060
2516	3.000	1.000	.083
62509	3.000	1.500	.044
19613	3.000	1.750	.050
11122	3.000	1.750	.058
2522	3.000	1.750	.078
22273	3.000	2.000	.125
14729	4.000	1.750	.060
2520	4.000	1.750	.078
22107	4.000	1.750	.109
22017	4.000	1.750	.125
2518	4.000	2.000	.109

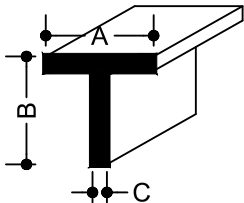

TEES

CLAVE	MEDIDAS EN PULGADAS		
	A	B	C
17256	0.750	0.750	.062
1613	1.000	1.000	.038

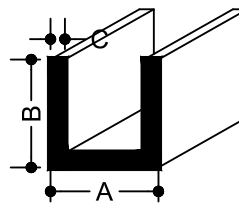

CANALES

CLAVE	MEDIDAS EN PULGADAS		
	A	B	C
1432	0.350	0.350	.035
4688	0.375	0.375	.063
1433	0.500	0.500	.030
18081	0.500	0.500	.063
40156	0.750	0.750	.063
17003	0.750	0.750	.125
1463	1.000	1.000	.063
17977	1.000	1.000	.125

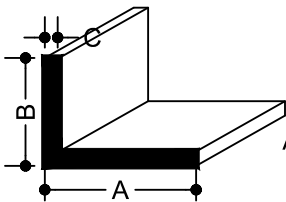

ÁNGULOS LADOS DESIGUALES

CLAVE	MEDIDAS EN PULGADAS		
	A	B	C
16	1.000	0.500	.125
622	1.500	0.750	.125
1364	1.500	1.000	.125
20	2.000	1.000	.125

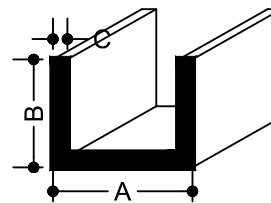

CANALES LADOS DESIGUALES

CLAVE	MEDIDAS EN PULGADAS		
	A	B	C
65498	0.750	0.500	.125
17196	2.000	1.000	.125
4018	2.500	1.500	.125
4017	3.000	1.000	.125
4802	3.000	1.500	.200

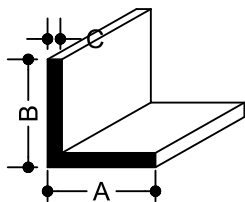

ÁNGULOS

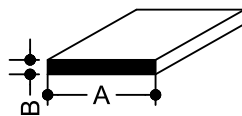

SOLERAS

CLAVE	MEDIDAS EN PULGADAS		
	A	B	C
11031	0.500	0.500	.050
1301	0.500	0.500	.062
9	0.500	0.500	.125
662	0.750	0.750	.040
11033	0.750	0.750	.050
1303	0.750	0.750	.062
11	0.750	0.750	.125
11124	1.000	1.000	.040
1324	1.000	1.000	.050
1304	1.000	1.000	.062
1308	1.000	1.000	.125
25	1.000	1.000	.188
569	1.250	1.250	.063
13	1.250	1.250	.125
26	1.250	1.250	.187
1320	1.500	1.500	.062
14	1.500	1.500	.125
1314	1.500	1.500	.187
372	1.500	1.500	.250
15	2.000	2.000	.125
330	2.000	2.000	.187
1318	2.000	2.000	.250
65496	2.500	2.500	.187
31	2.500	2.500	.250
29	3.000	3.000	.188
47	3.000	3.000	.250
667	4.000	4.000	.250

CLAVE	MEDIDAS EN PULGADAS	
	A	B
18040	0.375	.125
1203	0.500	.125
17578	0.500	.188
17582	0.500	.250
17572	0.625	.125
1201	0.750	.063
18028	0.750	.125
1211	0.750	.188
17584	0.750	.250
1202	1.000	.063
1205	1.000	.125
18091	1.000	.188
17980	1.000	.250
17593	1.000	.375
17574	1.250	.125
17580	1.250	.188
1207	1.500	.125
17083	1.500	.188
17981	1.500	.250
17595	1.500	.375
17597	1.500	.500
17576	2.000	.125
1216	2.000	.188
17708	2.000	.250
17088	2.000	.375
17091	2.000	.500
17086	2.500	.188
17588	2.500	.250
18041	3.000	.125
1218	3.000	.187
17589	3.000	.250
17089	3.000	.375
17092	3.000	.500
17687	4.000	.125
17591	4.000	.250
17628	4.000	.375
1241	4.000	.500
15009	5.000	.125
17592	6.000	.250

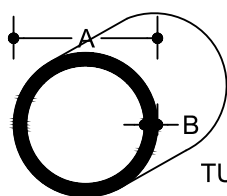

TUBO REDONDO

CLAVE	MEDIDAS EN PULGADAS	
	A	B
65524	0.375	.035
22004	0.375	.050
22023	0.500	.050
22015	0.625	.050
22505	1.000	.040
22356	1.250	.050
22197	1.500	.049
22196	2.000	.065
22326	2.500	.065

TUBO CUADRADO
ESQUINAS REDONDAS

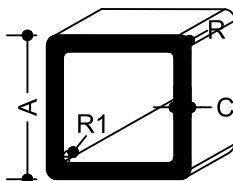















CLAVE	MEDIDAS EN PULGADAS			
	A	C	R	R1
22031	1.000	0.065	.156	.094
22034	1.500	0.065	.190	.125















CLAVE	FIGURA	SUP. ANOD. CM.	SUP. PUL. CM.	LARGO STD. M.	PIEZAS x ATADO	PÁGINA
00011	L	7.62	7.62	3.66	22	43
00013	L	12.70	12.70	3.66	14	43
00014	L	15.24	15.24	6.10	8	43
00015	L	20.22	20.22	3.66	8	43
00016	L	7.62	7.62	3.66	22	42
00020	L	15.24	15.24	3.66	11	42
00025	L	10.16	10.16	3.66	12	43
00029	L	30.48	30.48	3.66	4	43
00031	L	25.40	25.40	3.66	4	43
00047	L	30.48	30.48	3.66	3	43
00330	L	20.32	20.32	6.10	3	43
00372	L	15.24	15.24	3.66	6	43
00569	L	12.7	6.35	3.66	25	43
00622	L	11.43	11.43	3.66	16	42
00662	L	7.62	7.62	6.10	40	43

CLAVE	FIGURA	SUP. ANOD. CM.	SUP. PUL. CM.	LARGO STD. M.	PIEZAS x ATADO	PÁGINA
00667	L	40.64	40.64	3.66	2	43
1201	—	4.13	4.13	3.66	80	43
1202	—	5.40	5.40	3.66	40	43
1203	—	3.17	3.17	3.66	62	43
1205	—	5.71	5.71	3.66	30	43
1207	—	8.19	8.19	3.66	20	43
1211	—	4.76	4.76	3.66	26	43
1216	—	11.11	11.11	6.10	8	36 43
1241	—	22.86	22.86	3.66	2	43
1301	L STOCK MEX	5.08	5.08	6.10	40	43
1303	L STOCK MEX	7.62	7.62	3.66	32	43
1304	L STOCK MEX	10.16	10.16	6.10	24	43
1308	L	10.16	10.16	6.10	10	43
1314	L	15.24	15.24	3.66 6.10	8 4	43
1318	L	20.32	11.43	3.66	5	43

Perfiles de producción, pregunta por el mínimo de compra.

Los estatus de las claves pueden ir cambiando según demanda del mercado.

CLAVE	FIGURA	SUP. ANOD. CM.	SUP. PUL. CM.	LARGO STD. M.	PIEZAS x ATADO	PÁGINA
1320		15.24	15.24	3.66 6.10	16 16	43
1324	 STOCK MEX	10.062	10.062	6.10	32	43
1364	 STOCK MTY	12.7	12.70	6.10	10	42
1432		5.15	5.15	6	72	42
1433		7.47	7.47	6	72	42
1463		14.92	14.92	6.10	16	42
1613		10.16	10.16	6.10	32	42
2351		7.62	7.62	6.10	20	42
2354	 STOCK MEX	12.70	12.70	6.10	9	42
2356	 STOCK MEX	20.32	20.32	6.10	6	42
2358		30.48	30.48	6.10	2	42
2362	 STOCK MEX	10.16	10.16	6.10	16	42
2363	 STOCK MEX	15.24	15.24	6.10	9	42
2364	 STOCK MEX	17.76	17.76	6.10	9	42
2365		40.64	40.64	6.10	1	42











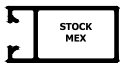

CLAVE	FIGURA	SUP. ANOD. CM.	SUP. PUL. CM.	LARGO STD. M.	PIEZAS x ATADO	PÁGINA
2369		30.48	30.48	6.10	4	42
2514		12.70	12.70	6.10	8	42
2515	 STOCK MEX	11.43	11.43	6.10	12	42
2516		20.32	20.32	6.10	4	42
2520		29.21	29.21	6.10	3	42
2521	 STOCK MEX	15.24	15.24	6.10	8	42
2522	 STOCK MEX	24.13	24.13	6.10	3	42
3316		8.00	5.18	6.10	24	32
4017		24.765	24.765	3.66	8	42
4018		27.305	27.305	3.66	6	42
4042		19.974	9.35	6.10	6	34
4043	 STOCK MTY	26.449	12.12	6.10	6	34
4081	 PRODUCCIÓN	33.4	17.13	6.10	2	34
4105		6	1.62	6.10	40	29
4154		10	7	3.66	16	32









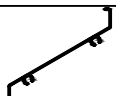

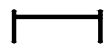
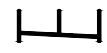
CLAVE	FIGURA	SUP. ANOD. CM.	SUP. PUL. CM.	LARGO STD. M.	PIEZAS x ATADO	PÁGINA
4688		5.40	5.40	3.66	70	42
5115	 STOCK MTY	8	1.65	6.10	24	29
5173		9	4	6.10	20	19
5472		25	8.26	6.10	10	39
6370		9.40	2.96	6.10	32	29
6371	 STOCK MEX	8.50	2.62	6.10	24	29
7014		6.13	2.14	6.10	36	32
7101		14.6	11.4	6.10	8	19
7102		13.50	6.69	6.10	12	32
7104	 STOCK MTY	21	10.48	6.40	8	21
7105	 STOCK MTY	22	14	6.40	8	21
7106	 STOCK MTY	27	13	6.40	8	21
7107	 STOCK MTY	20	7	6.40	12	21
7108	 STOCK MTY	23.50	10	6.40	8	21
7109	 STOCK MTY	51	7	6.40	4	21

CLAVE	FIGURA	SUP. ANOD. CM.	SUP. PUL. CM.	LARGO STD. M.	PIEZAS x ATADO	PÁGINA
7110	 STOCK MTY	32.83	4.67	6.40	6	21
7112	 STOCK MTY	20.30	14	6.40	8	21
7158	 PRODUCCIÓN	74.77	30.88	6.10	2	12
7333		8.06	3.10	6.10	40	19
7671		28.31	7.991	6.10	8	34
7792		14.50	0	6.10	16	6
7818		7.60	3.80	6.10	20	15
7828		10.50	5.30	6.10	16	18
7949		12.89	5.90	6.10	16	31
7950		15.421	8	5.70	16	31
8184	 STOCK MTY	14.25	4.20	6.10	12	10
8320		18.32	8.08	6.10	8	15
8328		40.80	18.20	6.10	1	35
8524		24.77	10.20	6.10	8	33
9078	 PRODUCCIÓN	10.38	0	6.10	28	4





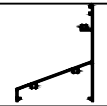

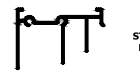
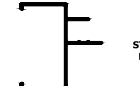







Perfiles de producción, pregunta por el mínimo de compra.













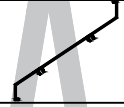

Los estatus de las claves pueden ir cambiando según demanda del mercado.

CLAVE	FIGURA	SUP. ANOD. CM.	SUP. PUL. CM.	LARGO STD. M.	PIEZAS x ATADO	PÁGINA
9086		30	8.30	6.10	8	6
9088		11.50	3.5	6.10	32	6
9112		13.23	4.80	6.10	12	7 9 24
9236		23.012	15.474	6.10	8	25
9356		8.01	3.30	6.10	24	4
9525		15.10	8.10	6.10	16	30
9756		13	10.30	6.10	12	30
9947		37	15.20	6.10	8	30
9956		19.10	8.206	6.10	12	14
9959		33.00	15.80	6.10	6	18
9960		28.882	12	6.10	8	18
9963		22.26	15.1	6.10	8	18
9964		23	21	6.10	6	18
9966		10.071	3.57	6.10	20	19
10087		23.80	11.814	6.10	8	37

CLAVE	FIGURA	SUP. ANOD. CM.	SUP. PUL. CM.	LARGO STD. M.	PIEZAS x ATADO	PÁGINA
10088		19	19	6.10	14	37
10197		14.88	3.17	5.70	20	30
10198		16.94	3.17	6.10	16	19
10220		7.80	2.37	5.70	30	19
10235		39	12.70	6.10	8	9
10236		35.30	7.90	6.10	6	9
10237		22.70	6	6.10	12	9
10266		21.30	0	6.10	12	8 10
10358		17.50	8.60	6.10	12	19
10465		50.20	15.03	6.10	4	24
10466		28.17	12.88	6.10	8	24
10467		47	11.20	6.10	4	24
10554		7.08	3.45	6.10	32	24
10568		26.03	6.30	6.40	8	20
10570		25.57	16.71	6.40	8	20



CLAVE	FIGURA	SUP. ANOD. CM.	SUP. PUL. CM.	LARGO STD. M.	PIEZAS x ATADO	PÁGINA
10571	 STOCK MTY	18.60	6.73	6.40	12	20
10574	 STOCK MTY	8.03	3	6.40	24	20
10575	 STOCK MTY	9.67	3.03	6.40	24	20
10581		55.57	15.39	6.10	2	39
10697		48.30	20.90	6.10	4	24
11005	 PRODUCCIÓN	33.10	23.70	6.10	2	39
11031	 STOCK MEX	5.08	5.08	6.10	40	43
11032		7.15	1.86	6.10	48	25 29
11033		7.62	7.62	6.10	32	43
11035		11.30	3.37	6.10	12	31
11044		18.27	8.11	6.10	12	14
11046		14.194	10.463	6.10	12	31
11093		17.76	17.76	6.10	9	42
11096	 STOCK MTY	9.60	3.45	6.10	32	13
11099		19.05	19.05	6.10	6	42































CLAVE	FIGURA	SUP. ANOD. CM.	SUP. PUL. CM.	LARGO STD. M.	PIEZAS x ATADO	PÁGINA
11122		24.13	24.13	6.10	3	42
11124		10.16	10.16	6.10	32	43
11154		12.70	12.70	6.10	9	42
11156		20.32	20.32	6.10	6	42
11161		10.16	10.16	6.10	16	42
11162		34.956	34.956	6.10	4	38
11163		17.62	8.927	6.10	12	39
11173		15.41	11.958	6.10	12	31
11174		34.90	15.20	6.10	8	31
11176	 STOCK MEX	29.50	12.50	6.10	8	31
11203		13.20	5.82	6.10	12	13 15
11286		17.97	0	6.10	8	39
11386		14.90	4.01	5.70	24	31
11387		17.16	4.011	6.10	16	31
11417		45.46	14.78	6.10	2	39

Perfiles de producción, pregunta por el mínimo de compra.

Los estatus de las claves pueden ir cambiando según demanda del mercado.













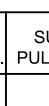
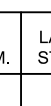

CLAVE	FIGURA	SUP. ANOD. CM.	SUP. PUL. CM.	LARGO STD. M.	PIEZAS x ATADO	PÁGINA
11599		17.20	9.65	6.10	10	37
11670		26.52	10.203	6.10	8	33
11763		5.55	0	6.10	40	13
11835		36.69	7.349	6.10	12	13
11836		14.24	5.08	6.10	16	13
11837		18.659	8.1	6.10	12	13
11838		17.5	3.98	6.10	12	13
12115		37.8	14.70	6.10	2	33
12208		31.75	31.75	6.10	2	41
12428		9.99	8.18	6.10	22	34
12797		36.95	11.90	6.40	6	20
13563		14.80	7.53	6.10	20	30
14286		21.28	7.08	6.10	8	14
14668		73.03	24.52	6.10	2	40
14669		63.58	24.52	6.10	2	40













CLAVE	FIGURA	SUP. ANOD. CM.	SUP. PUL. CM.	LARGO STD. M.	PIEZAS x ATADO	PÁGINA
14729		29.21	29.21	6.10	4	42
15309		28.663	6.46	6.10	12	13
15310		18.471	4.05	6.10	16	13
15311		18.431	7.81	6.10	12	13
15312		13.428	8.88	6.10	16	13
17003		10.69	5.66	3.66	18	42
17083		8.57	8.57	3.66	12	43
17084		9.84	9.84	3.66	9	43
17086		13.65	13.65	3.66	8	43
17088		12.065	12.065	3.66	5	43
17089		17.145	17.145	3.66	4	43
17091		12.70	12.70	3.66	4	43
17092		17.78	17.78	3.66	2	43
17196		19.685	19.685	3.66	8	42
17231		10.16	10.16	3.66	17	42

CLAVE	FIGURA	SUP. ANOD. CM.	SUP. PUL. CM.	LARGO STD. M.	PIEZAS x ATADO	PÁGINA	CLAVE	FIGURA	SUP. ANOD. CM.	SUP. PUL. CM.	LARGO STD. M.	PIEZAS x ATADO	PÁGINA
17256		7.62	7.62	3.66	32	42	17597		10.16	10.16	3.66	5	43
17572		3.745	3.745	3.66	50	43	17628		22.225	22.225	3.66	3	43
17574		6.92	6.92	3.66	24	43	17708		11.43	11.43	3.66	8	43
17576		10.73	10.73	3.66	16	43	17977		14.6	7.62	3.66	12	42
17578		3.49	3.49	3.66	42	43	17978		2.79	2.79	3.66	125	43
17580		7.30	7.30	3.66	17	43	17980		6.35	6.35	3.66	14	43
17582		3.81	3.81	3.66	30	43	17981		8.89	8.89	3.66	10	43
17584		5.08	5.08	3.66	22	43	18028		4.38	4.38	3.66	42	43
17588		13.97	13.97	3.66	6	43	18040		2.475	2.475	3.66	82	43
17589		16.51	16.51	3.66	5	43	18041		15.81	15.81	3.66	10	43
17591		21.59	21.59	3.66	4	43	18081		7.30	7.30	3.66	50	42
17592		31.75	31.75	3.66	3	43	18091		6.03	6.03	3.66	12	43
17593		6.985	6.985	3.66	12	43	18270	 STOCK MTY	39.92	11.21	6.10	4	10
17594		8.255	8.255	3.66	8	43	18490		12.06	12.06	3.66	14	42
17595		9.525	9.525	3.66	8	43	19095		5.715	5.715	3.66	16	43

Perfiles de producción, pregunta por el mínimo de compra.

Los estatus de las claves pueden ir cambiando según demanda del mercado.

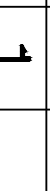
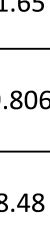
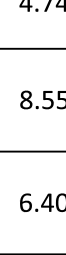
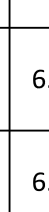
CLAVE	FIGURA	SUP. ANOD. CM.	SUP. PUL. CM.	LARGO STD. M.	PIEZAS x ATADO	PÁGINA
19272	 STOCK MTY	20.50	13.38	6.40	16	20
19613		24.13	24.13	6.10	4	43
20569	 STOCK MTY	27.84	6.72	6.40	8	20
20572		9.98	1	6.10	24	20
22004		2.99	2.99	6.10	46	44
22015		4.987	4.987	3.66 6.10	44 26	44
22017		29.21	29.21	6.10	2	47
22023		3.99	3.99	3.66 6.10	55 33	44
22026		24.13	24.13	6.10	3	47
22031		8.43	8.43	6.10	12	44
22034		14.41	14.41	6.10	6	44
22036		7.62	7.62	6.10	16	43
22049		7.62	7.62	6.10	14	42
22107		29.14	29.14	6.10	2	42
22117		9.97	9.97	6.10	10	43















CLAVE	FIGURA	SUP. ANOD. CM.	SUP. PUL. CM.	LARGO STD. M.	PIEZAS x ATADO	PÁGINA
22196		15.96	15.96	3.66 6.10	8 6	43
22197		11.97	11.97	6.10	9	43
22242		20.32	20.32	6.10	6	42
22268		15.24	15.24	6.10	4	42
22273		25.40	25.40	6.10	2	42
22326		19.95	19.95	3.66	6	43
22356		9.97	9.97	6.10	12	43
22505		7.98	7.98	3.66 6.10	24 12	43
24051		11.65	4.74	6.10	16	6
24055		19.806	8.55	6.10	10	11
26606		18.48	6.40	6.10	12	12
26609		30.05	7.44	6.10	8	11
27111	 STOCK MTY	37.86	9.098	6.40	6	21
27316		17.2	7.28	6.10	12	7
27525		10.813	1.20	6.10	16	15















Perfiles de producción, pregunta por el mínimo de compra.

Los estatus de las claves pueden ir cambiando según demanda del mercado.

CLAVE	FIGURA	SUP. ANOD. CM.	SUP. PUL. CM.	LARGO STD. M.	PIEZAS x ATADO	PÁGINA
27819		43.38	8.75	6.10	6	14
27862		49.018	7.36	6.10	4	16
28009		62.56	26.596	6.10	1	35
28183		33.152	6.74	6.10	8	10
28586		37.303	14.04	6.10	4	6
28681		17.35	2.13	6.10	12	18
28936		24.45	6.24	6.10	6	23
28937		31.249	5.80	6.10	6	23
28939		15.38	5.10	6.10	12	23
29076		21.133	9.165	6.10	12	4
29117		55.753	19.46	6.10	4	11
29118		48.178	13.159	6.10	4	12
29119		45.63	20.61	6.10	4	11
29183		19.67	8.60	6.10	6	28
29207		22.782	10.562	6.10	6	28

CLAVE	FIGURA	SUP. ANOD. CM.	SUP. PUL. CM.	LARGO STD. M.	PIEZAS x ATADO	PÁGINA
33087		18.79	4.24	6.10	14	25
35844		25.697	12.91	6.10	8	29
36370		10.40	2.90	6.10	32	4 29
37825		27.75	15.76	6.10	8	14
38370		26.74	3.04	6.10	8	14
39073		25.95	8.20	6.10	12	4
39074		22.20	5.32	6.10	12	4
39075		11.09	2.39	6.10	24	4
39084		28.91	6.885	6.10	8	6
39088		10.442	3.517	6.10	32	6
39115		54.639	21.87	6.10	4	8
39136		39.041	10.82	6.10	6	7
39272		33.199	9.416	6.10	6	17
39954		17.897	8.418	6.10	8	15
40156		11.11	11.11	6.10	20	42

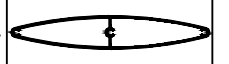
CLAVE	FIGURA	SUP. ANOD. CM.	SUP. PUL. CM.	LARGO STD. M.	PIEZAS x ATADO	PÁGINA
50170		5.08	5.08	6.10	30	42
52500		7.62	7.62	6.10	20	42
53358		15.79	6.75	6.10	12	32
53883		27.32	22.57	6.10	3	36
53896		22.219	17.42	6.10	2	36
59187		33.425	16.183	6.10	4	28
59204		21.54	16.913	4.60 6.10	6 6	28
62488		10.16	10.16	6.10	16	42
62489		15.24	15.24	6.10	9	42
62509		22.86	22.86	6.10	3	42
62515		11.43	11.43	6.10	12	42
62521		15.24	15.24	6.10	8	42
63299		17.61	17.61	6.10	13	37
63329		14.846	2.90	6.10	20	32
63463		32.88	25.35	6.10	2	41

CLAVE	FIGURA	SUP. ANOD. CM.	SUP. PUL. CM.	LARGO STD. M.	PIEZAS x ATADO	PÁGINA
63727		13.34	3.46	6.10	16	15
63728		17.96	7.01	6.10	6	15
65321		20.32	20.32	6.10	6	42
65439		34.93	17.46	3.66	1	42
65498		8.26	4.45	3.66	24	42
65524		2.992	2.992	6.10	50	43
65844		18.535	9.25	6.10	12	28
66053		24.35	10.81	6.10	8	37
66533		21.293	9.47	6.10	12	19
66534		17.001	9.354	4.60	8	19
66617		31.77	28.76	6.10	6	33
67013		9.66	2	6.10	36	32
67315		25.779	6.17	6.10	8	7
67362		31.61	31.61	6.10	3	38
67518		37.168	8.07	6.10	8	14

Perfiles de producción, pregunta por el mínimo de compra.

Los estatus de las claves pueden ir cambiando según demanda del mercado.

CLAVE	FIGURA	SUP. ANOD. CM.	SUP. PUL. CM.	LARGO STD. M.	PIEZAS x ATADO	PÁGINA
67819		49.52	8.64	6.10	6	14
67821		14.10	10.76	4.60	12	15
67822		22.22	15.92	6.10	8	15
67826		43.24	23.11	6.10	6	16
67835		35.059	13.20	6.10	8	25 16
67836		24.386	8.619	6.10	8	25 16
67848		29.311	16.182	4.60	8	17
67850		27.25	13.93	6.10	6	17
67862		56.03	6.87	6.10	4	17
68327		39.90	18.28	6.10	1	35
68370		26.74	3.04	6.10	8	14
67842		34.343	17.17	6.10	4	25 16
67843		26.181	10.87	6.10	8	17
67844		24.798	11.31	6.10	8	17
67847		22.031	14.774	4.60	8	17

CLAVE	FIGURA	SUP. ANOD. CM.	SUP. PUL. CM.	LARGO STD. M.	PIEZAS x ATADO	PÁGINA
68550		20.58	9.55	6.10	12	25
68591		26.861	11.381	6.10	8	6
69082		27.448	9.86	6.10	8	18 26
69083		32.69	0	6.10	8	6
69085		15.7	3.62	6.10	16	6
69105		41.458	12.1	6.10	4	7
69114		37.57	16.72	6.10	4	7
69135		46.023	15.365	6.10	4	7
69272		32.562	11.12	6.10	6	16
69366		31.696	12.322	6.10	6	36
69768		23.721	8.512	6.10	12	16
69776		58.709	25.68	6.10	1	35
69955		21.557	10.985	4.60	12	15
69957		27.682	16.461	6.10	8	16
73971		20.34	13.23	6.10	8	5 22

CLAVE	FIGURA	SUP. ANOD. CM.	SUP. PUL. CM.	LARGO STD. M.	PIEZAS x ATADO	PÁGINA	CLAVE	FIGURA	SUP. ANOD. CM.	SUP. PUL. CM.	LARGO STD. M.	PIEZAS x ATADO	PÁGINA
73972		24.70	21.35	6.10	7	22	74075		38.18	24.59	6.10	2	26
73973		23.70	16.66	6.10	6	22	74634		11.07	2.56	6.10	30	5 22 27
73974		38.12	24.09	6.10	2	27	74635		11.98	2.97	6.10	30	5 22 27
73978		13.91	4.25	6.10	30	5 22 27	74636		29.22	22.733	6.10	6	22
73981		24.70	21.35	6.10	6	22	75024		29.00	25.26	6.10	6	22
73983		28.13	24.79	6.10	2	26	75110		9.18	6.88	6.10	20	22
73985		28.138	24.79	6.10	2	26	77862		49.65	9.80	6.10	6	16
74073		13.07	6.77	6.10	30	5 22 27	81581		32.485	13.08	6.10	6	33
74074		27.33	12.11	6.10	2	26							

Perfiles de producción, pregunta por el mínimo de compra.

Los estatus de las claves pueden ir cambiando según demanda del mercado.

Agradeceremos sus comentarios sobre este catálogo.
 Atención: Departamento de asesoría técnica Grupo Cuprum.
 Contacto: vozdelcliente@cuprum.com



CUPRUM

EUROVENT



Recuerda que en Cuprum contamos con líneas exclusivas
que te permitirán destacarte frente a la competencia.
Descúbrelas visitando www.ventanaseurovent.com.

¡Certifica tu taller!
Consulta a tu distribuidor para obtener más información.

PANORAMA

Este manual y sus diseños están protegidos por diversas patentes.
Los perfiles y sus diseños son propiedad exclusiva de Cuprum.
Queda estrictamente prohibida su reproducción, total o parcial.



CUPRUM





Planta y Ventas en México

Av. La Presa # 290, Col. San Juan Ixhuatepec
Tlanepantla, Edo. de México, C.P. 54180
Tels.: (55) 5 746 7900 / (55) 5746 7800 / (55) 5746 7975

Planta y Ventas en Guadalajara

Antigua Carretera a Chapala # 3345, Alamo Industrial
Guadalajara, Jalisco, C.P. 44470
Tel.: (33) 3666 9000

Sala de Exhibición Monterrey

Plaza Tanarah/ Av Vasconcelos 345 Ote., Segundo piso
Local 17 y 18, San Pedro Garza García, Nuevo León.
Tel: (81) 8356 6529, 8356 6611, 8356 6263

Planta y Ventas en Monterrey

Av. Diego Días de Berlanga # 132 Nte., Col. El Nogalar,
San Nicolás de los Garza, N.L., C.P. 66480
Tels.: (81) 8305 8500 / (81) 8305 8600

Sala de Exhibición Ciudad de México

Altavista #79 entre Av. Revolución y Camino a Desierto de
los Leones, Col. San Angel Inn, Del. Álvaro Obregón, CDMX
Tel: (55) 5550 3690, (55) 5616 6674, (55) 5616 7308

<https://cuprum.com/construccion/>

